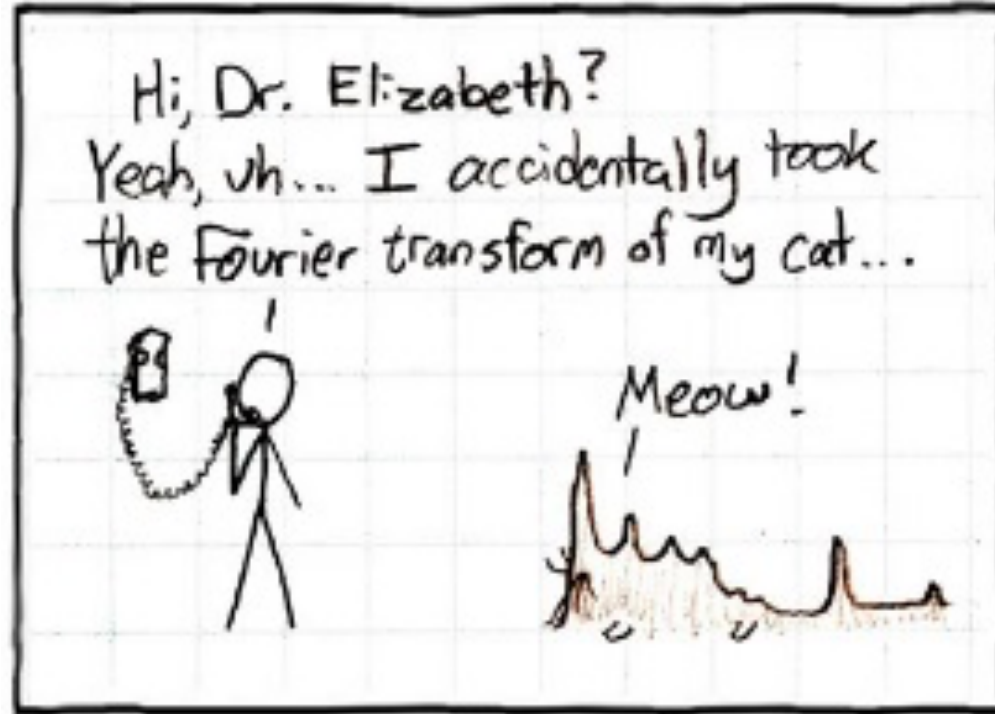

Image pyramids and frequency domain



Course announcements

- Programming assignment 1 (will be) posted on course website.
 - Due on September 23rd at 23:59.
- Office hours for the rest of the semester:
 - Tuesdays, 5 pm - 7 pm, Prakhar
 - Thursdays, 10 am - noon, Varun
 - Friday, 4 pm - 6 pm, Chaoyang

Overview of today's lecture

- Image downsampling.
- Aliasing.
- Gaussian image pyramid.
- Laplacian image pyramid.
- Fourier series.
- Frequency domain.
- Fourier transform.
- Frequency-domain filtering.
- Revisiting sampling.

Slide credits

Most of these slides were adapted directly from:

- Kris Kitani (15-463, Fall 2016).

Some slides were inspired or taken from:

- Fredo Durand (MIT).
- Bernd Girod (Stanford University).
- James Hays (Georgia Tech).
- Steve Marschner (Cornell University).
- Steve Seitz (University of Washington).

Image downsampling



**This image is too big to fit on the screen.
How would you reduce it to half its size?**

Naïve image downsampling

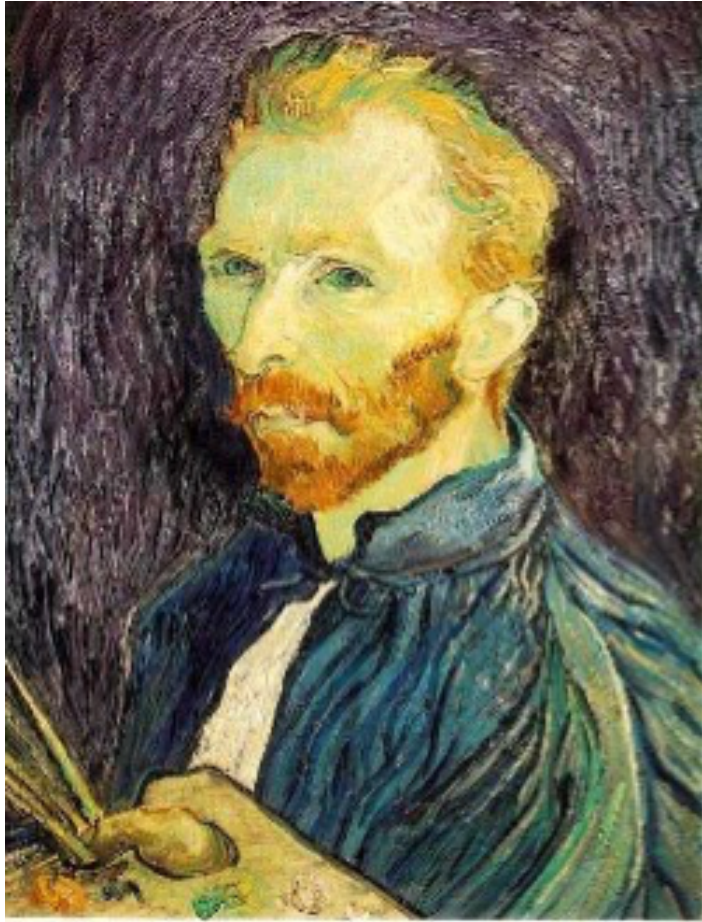

1/2

Throw away half the rows and columns

delete even rows
delete even columns



1/4

delete even rows
delete even columns



1/8

What is the problem with this approach?

Naïve image downsampling

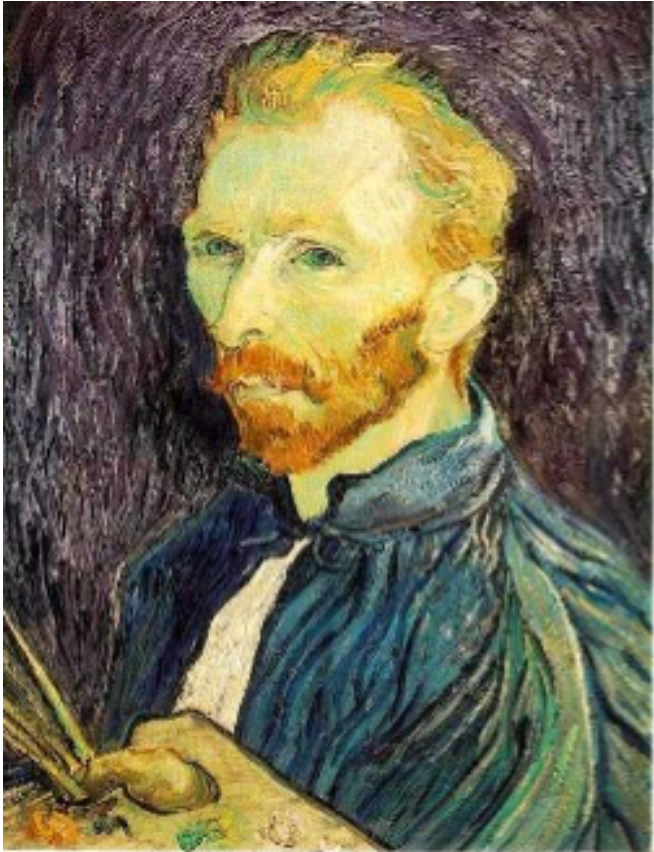

1/2



1/4 (2x zoom)



1/8 (4x zoom)

Why is the 1/8 image so pixelated (and do you know what this effect is called)?

Aliasing

Reminder

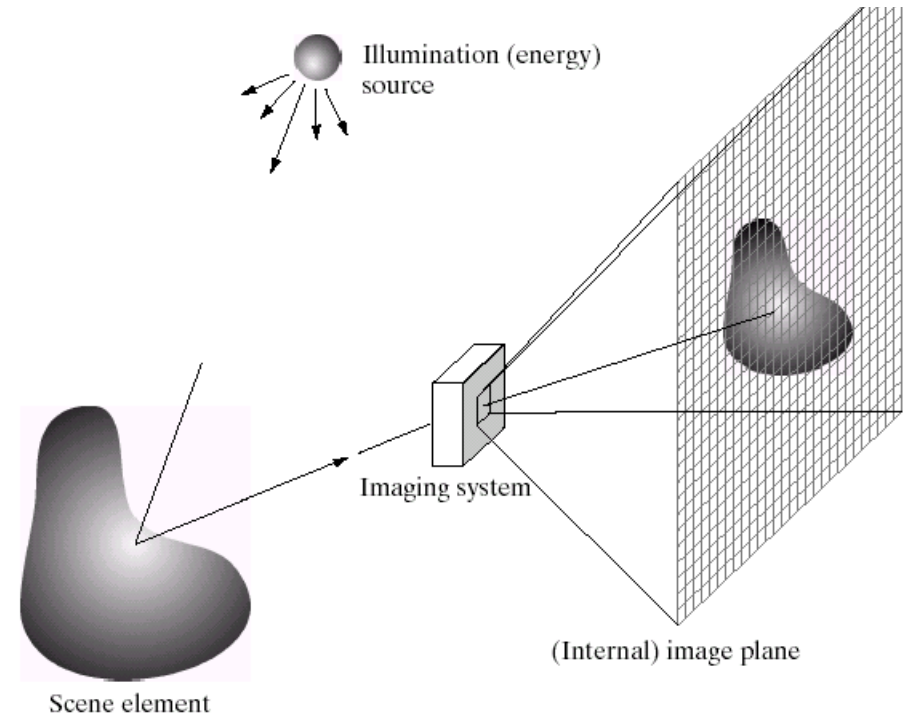

Images are a *discrete*, or *sampled*, representation of a *continuous* world

Sampling

Very simple example: a sine wave

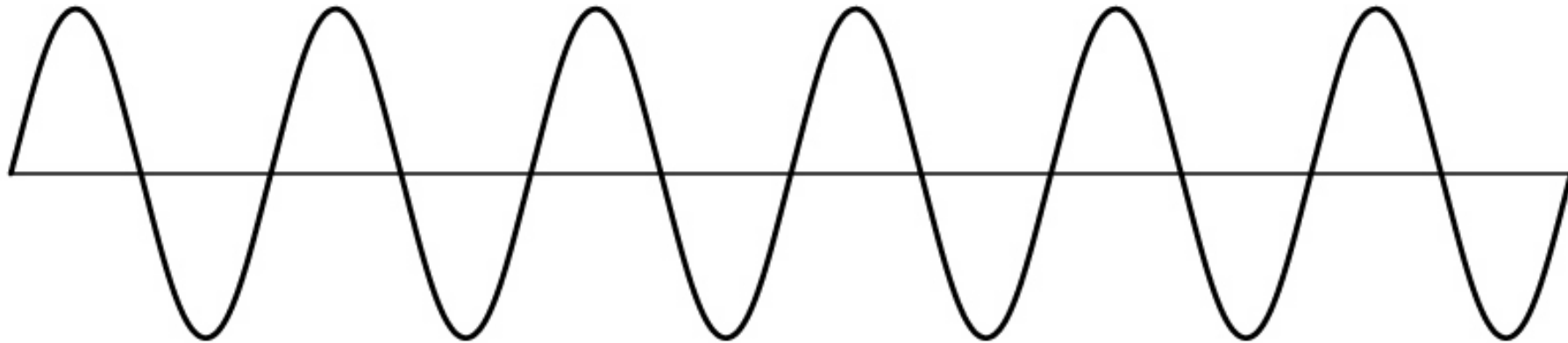

How would you discretize this signal?

Sampling

Very simple example: a sine wave

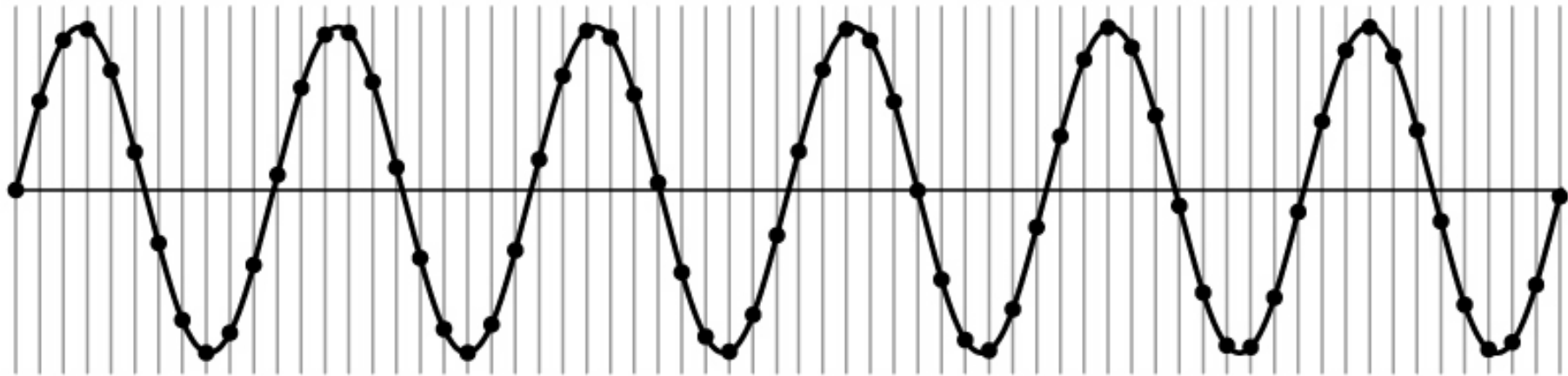

Sampling

Very simple example: a sine wave

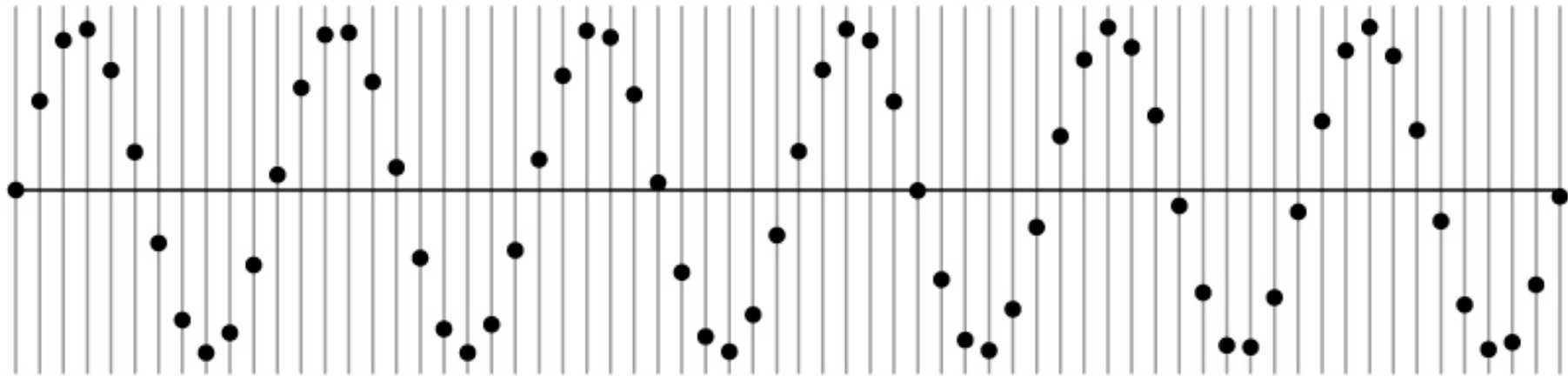

How many samples should I take?

Can I take as *many* samples as I want?

Sampling

Very simple example: a sine wave

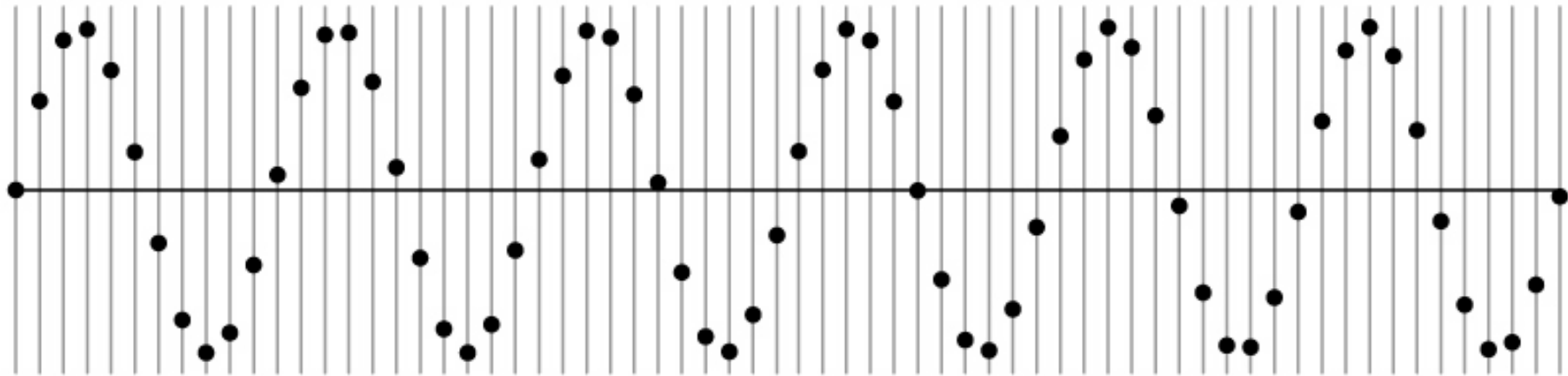

How many samples should I take?

Can I take as *few* samples as I want?

Undersampling

Very simple example: a sine wave

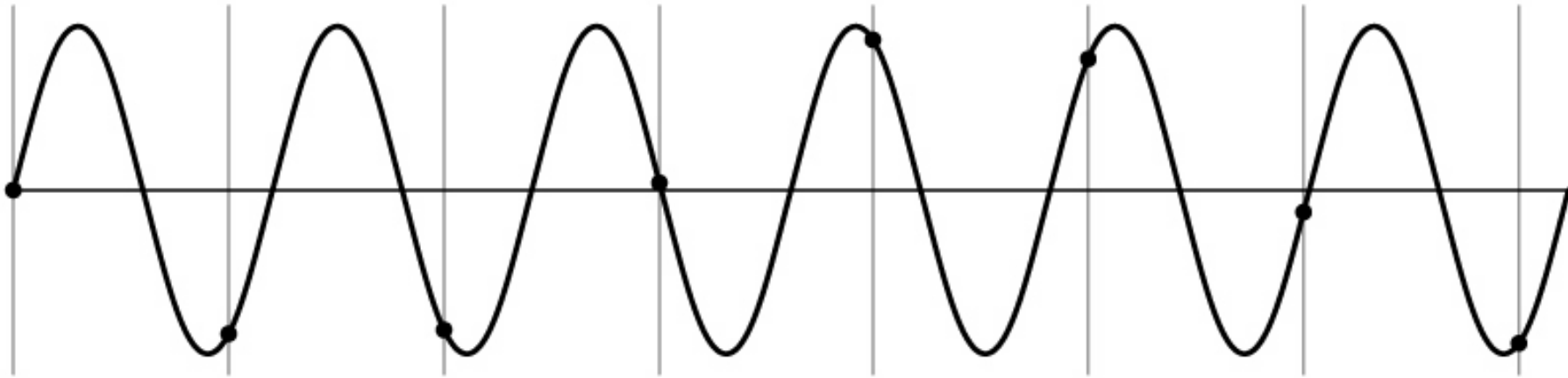

Unsurprising effect: information is lost.

Undersampling

Very simple example: a sine wave

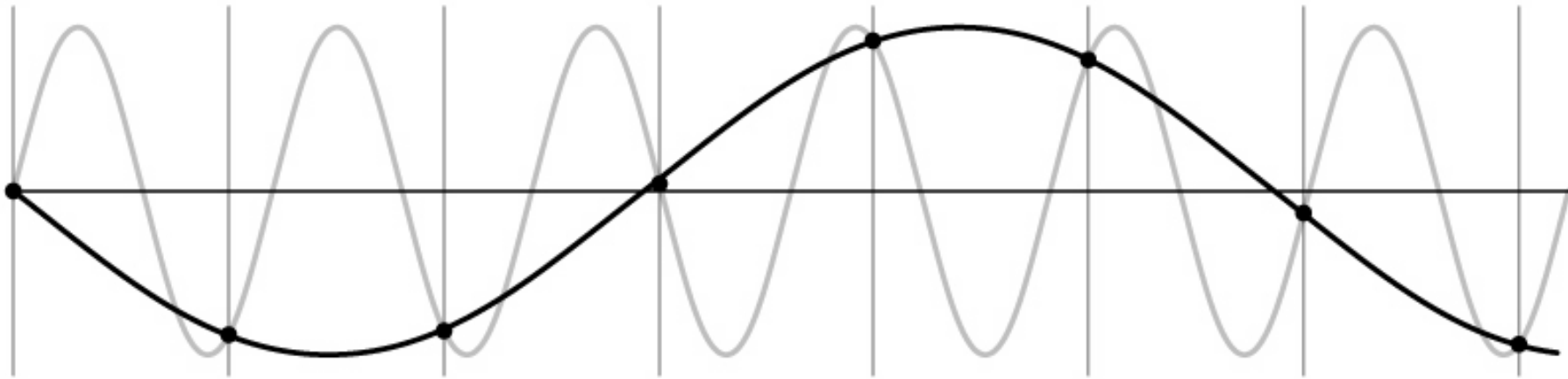

Unsurprising effect: information is lost.

Surprising effect: can confuse the signal with one of *lower* frequency.

Undersampling

Very simple example: a sine wave

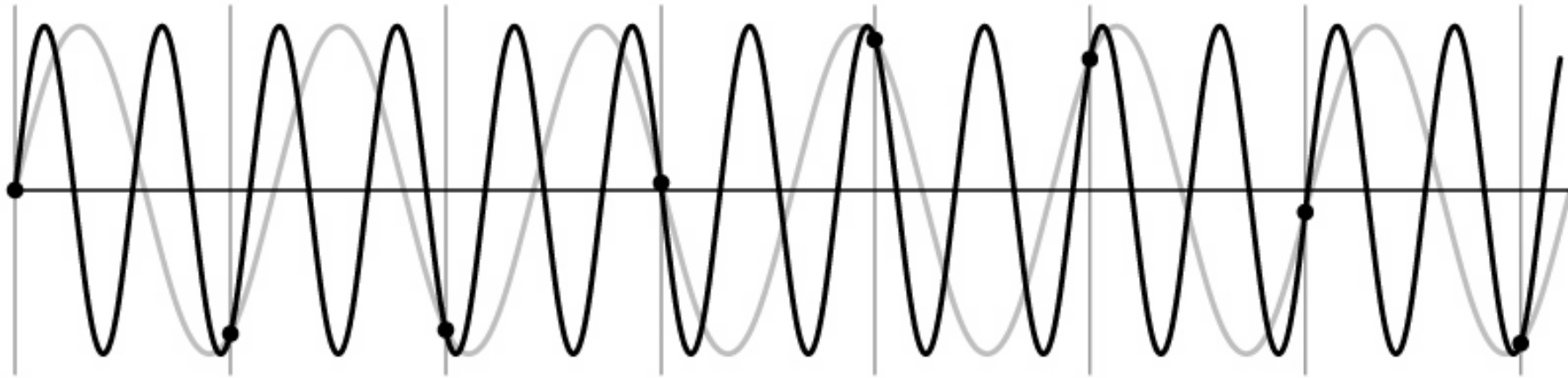

Unsurprising effect: information is lost.

Surprising effect: can confuse the signal with one of *lower* frequency.

Note: we could always confuse the signal with one of *higher* frequency.

Aliasing

Fancy term for: *Undersampling can disguise a signal as one of a lower frequency*

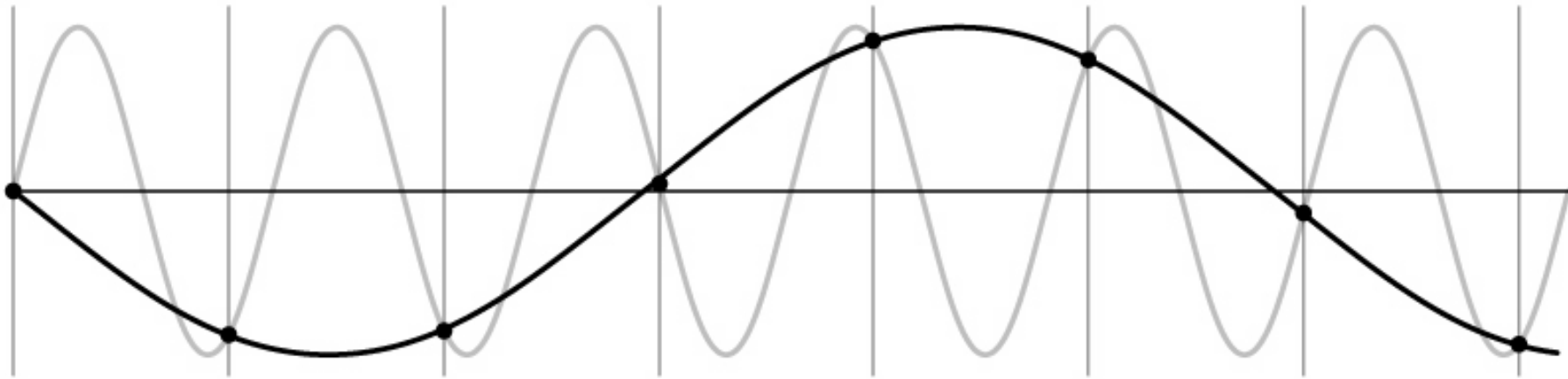

Unsurprising effect: information is lost.

Surprising effect: can confuse the signal with one of *lower* frequency.

Note: we could always confuse the signal with one of *higher* frequency.

Aliasing in textures

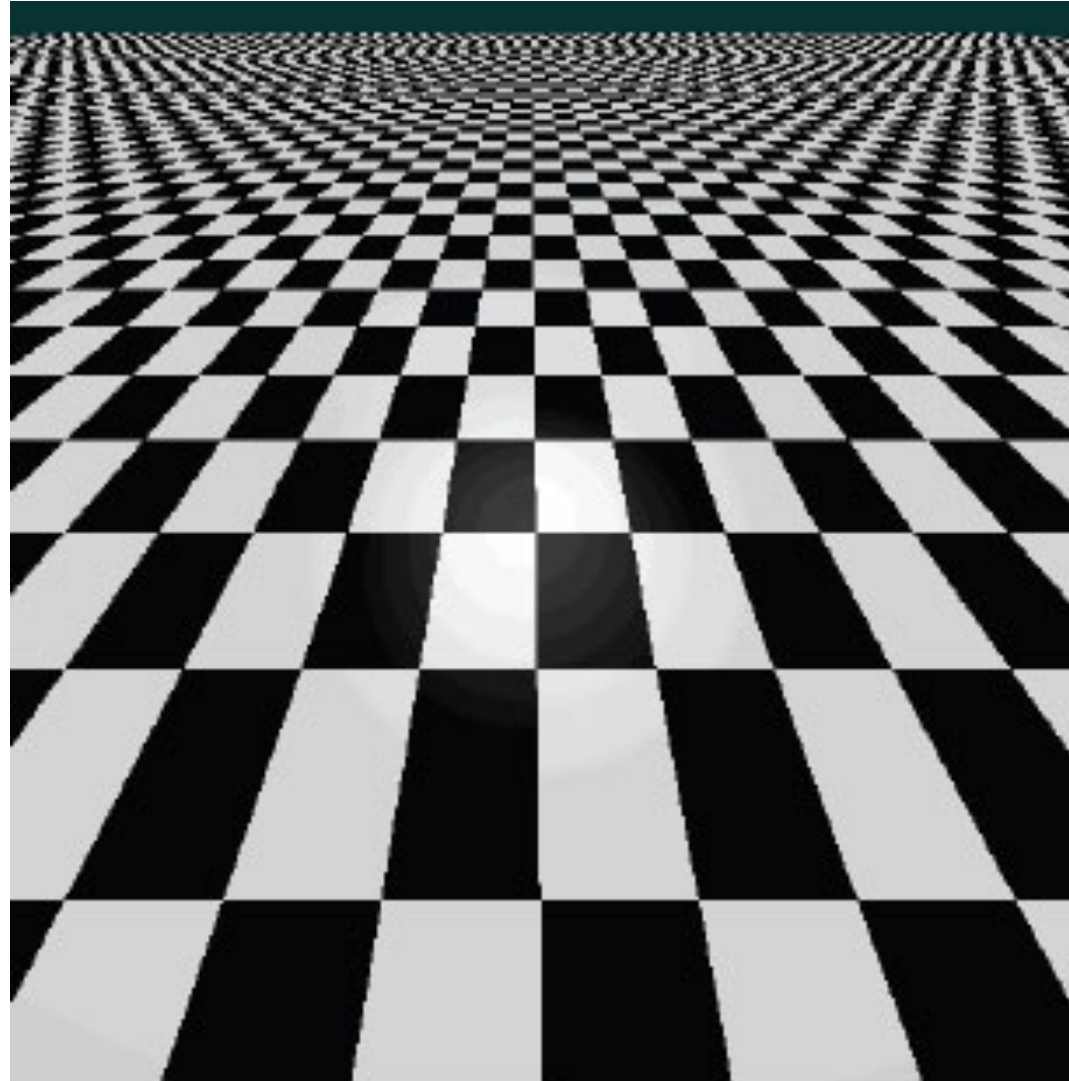

Aliasing in photographs

This is also known as “moire”



Temporal aliasing

Imagine a spoked wheel moving to the right (rotating clockwise).

Mark wheel with dot so we can see what's happening.

If camera shutter is only open for a fraction of a frame time (frame time = 1/30 sec. for video, 1/24 sec. for film):

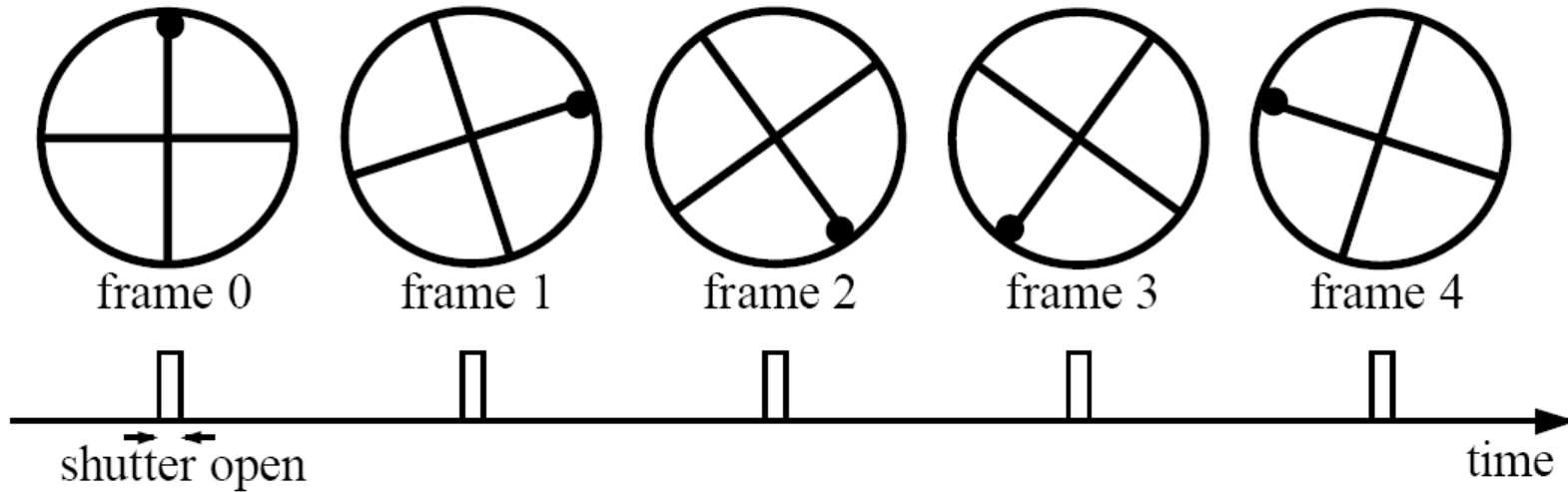

Without dot, wheel appears to be rotating slowly backwards!
(counterclockwise)

Wagon wheel effect

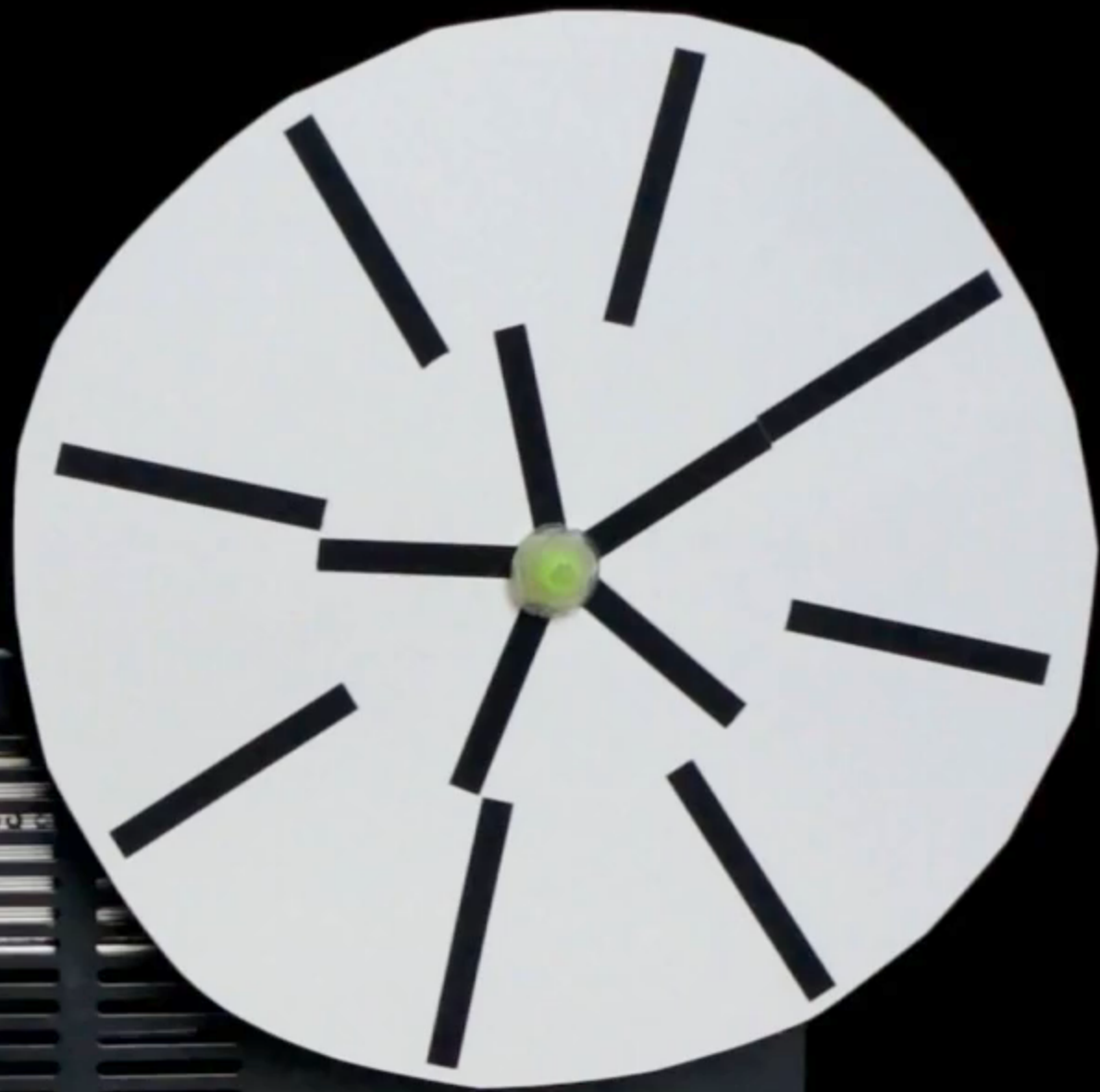



Anti-aliasing

How would you deal with aliasing?

Anti-aliasing

How would you deal with aliasing?

Approach 1: Oversample the signal

Anti-aliasing in textures

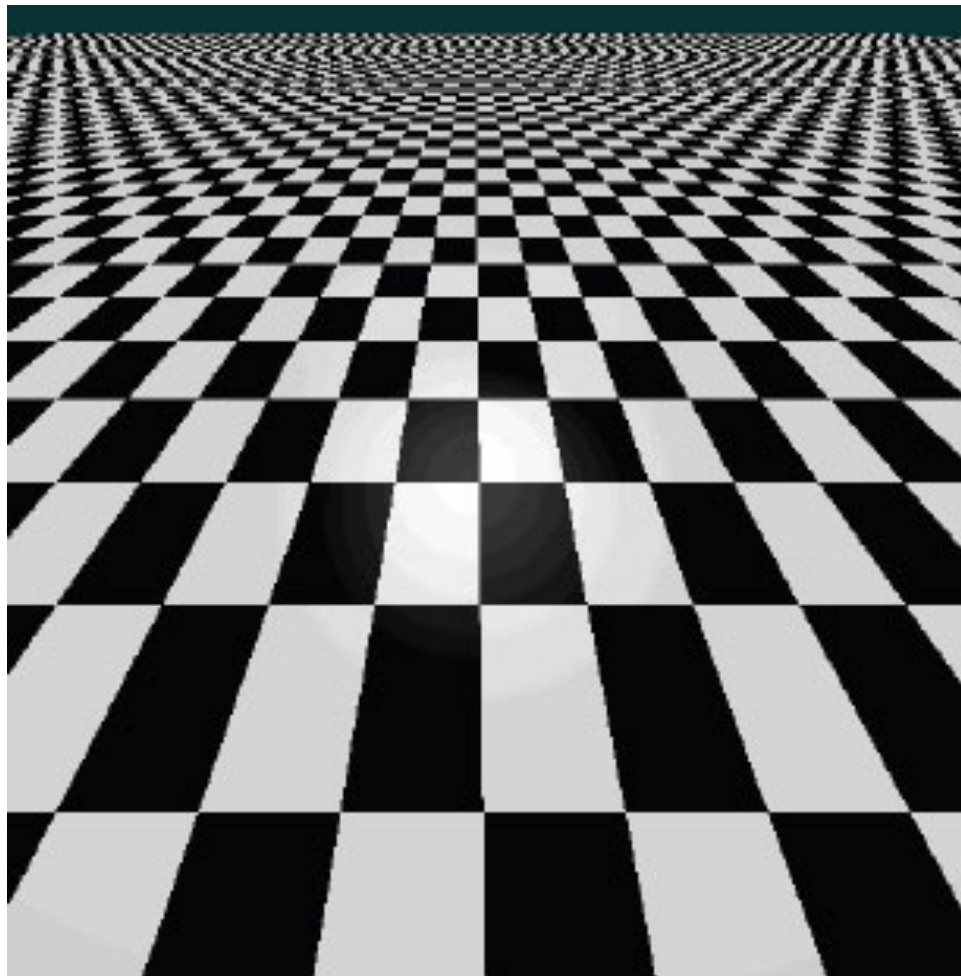

aliasing artifacts

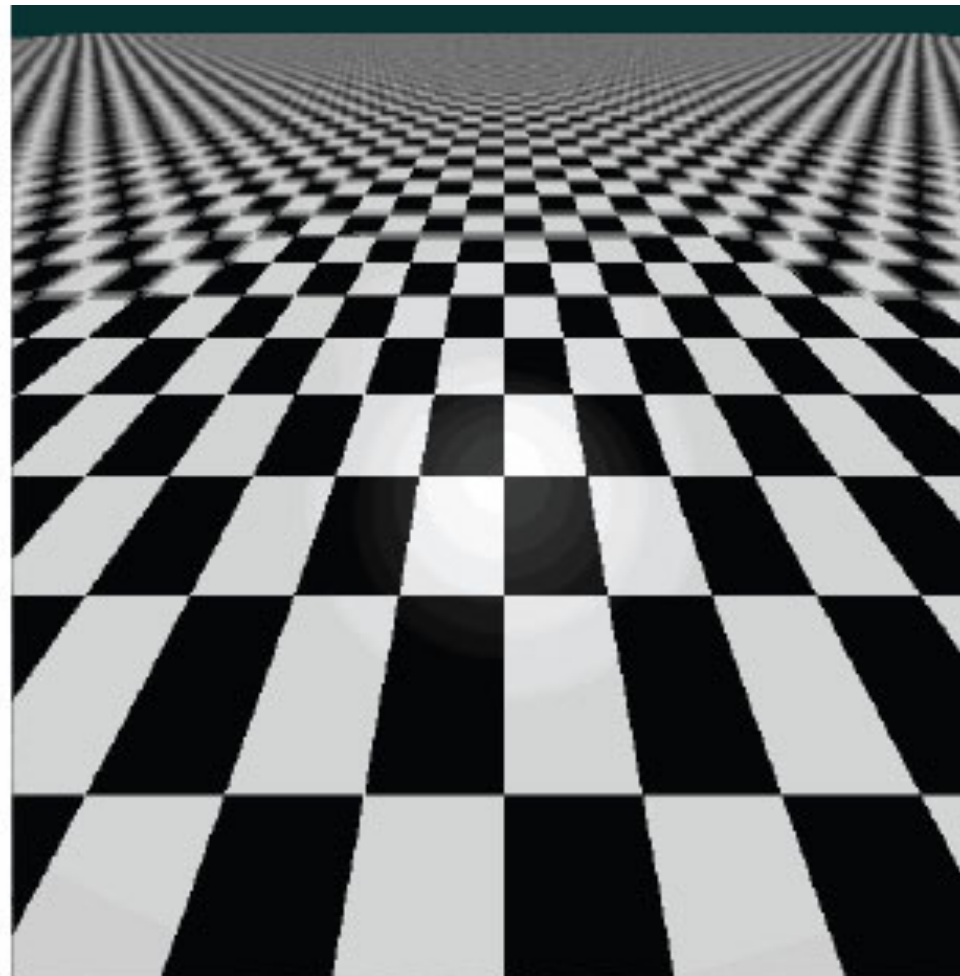

anti-aliasing by oversampling

Anti-aliasing

How would you deal with aliasing?

Approach 1: Oversample the signal

Approach 2: Smooth the signal

- Remove some of the detail effects that cause aliasing.
- Lose information, but better than aliasing artifacts.

How would you smooth a signal?

Better image downsampling

Apply a smoothing filter first, then throw away half the rows and columns

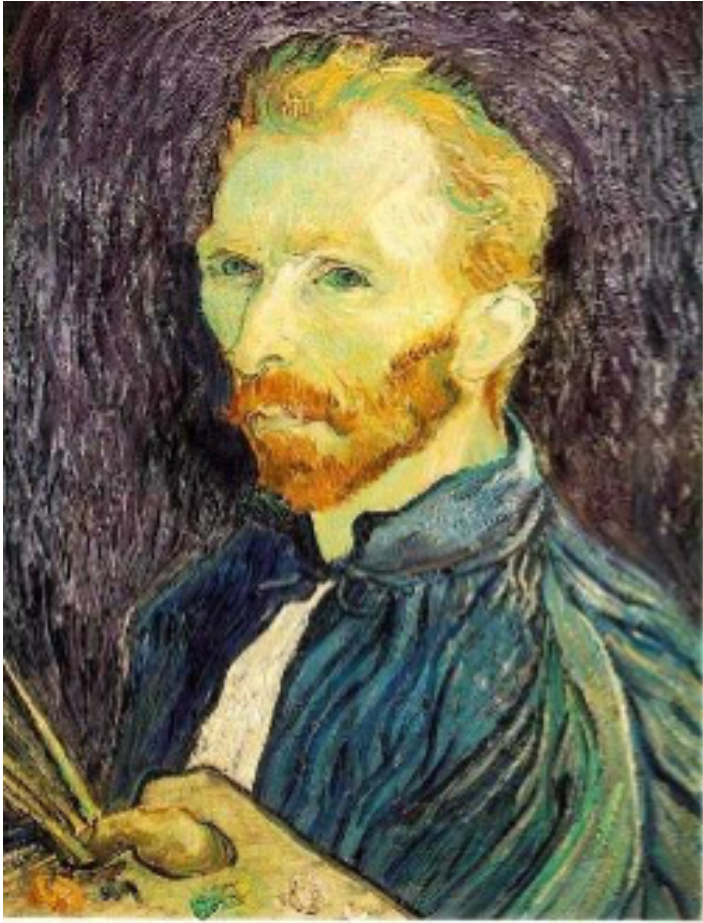

1/2

Gaussian filter
delete even rows
delete even columns



1/4

Gaussian filter
delete even rows
delete even columns



1/8

Better image downsampling

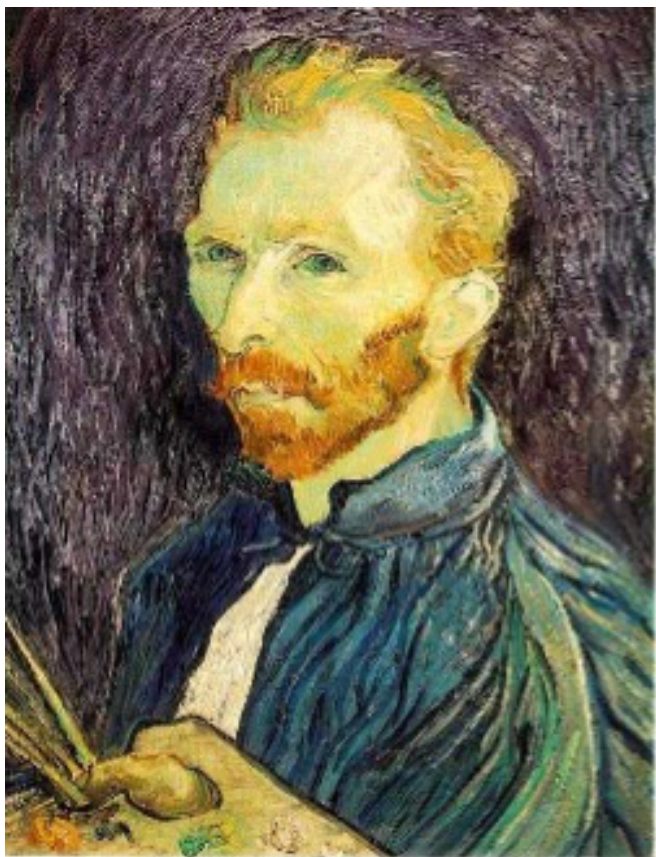

1/2



1/4 (2x zoom)



1/8 (4x zoom)

Naïve image downsampling

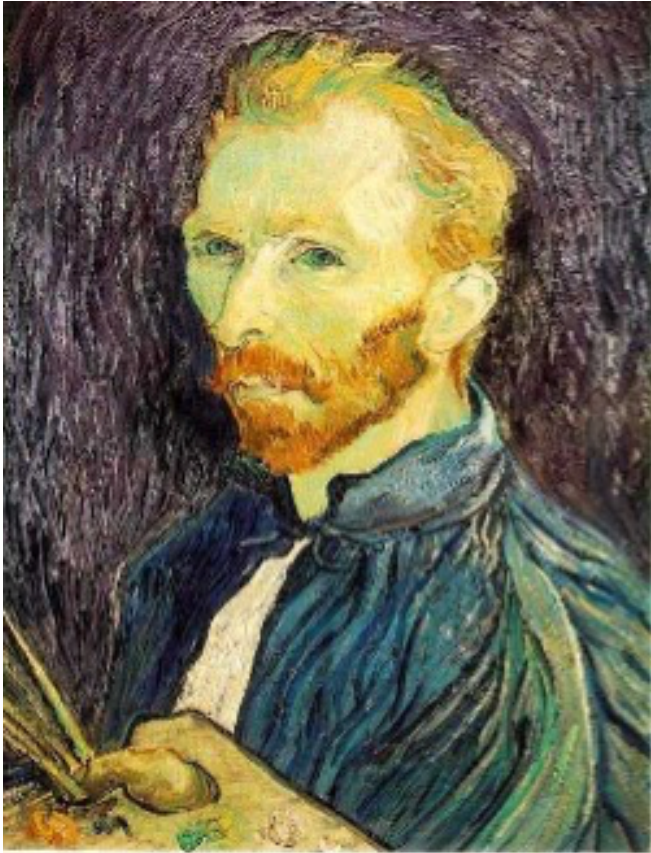

1/2



1/4 (2x zoom)



1/8 (4x zoom)

Anti-aliasing

Question 1: How much smoothing do I need to do to avoid aliasing?

Question 2: How many samples do I need to take to avoid aliasing?

Answer to both: Enough to reach the Nyquist limit.

We'll see what this means soon.

Gaussian image pyramid

Gaussian image pyramid

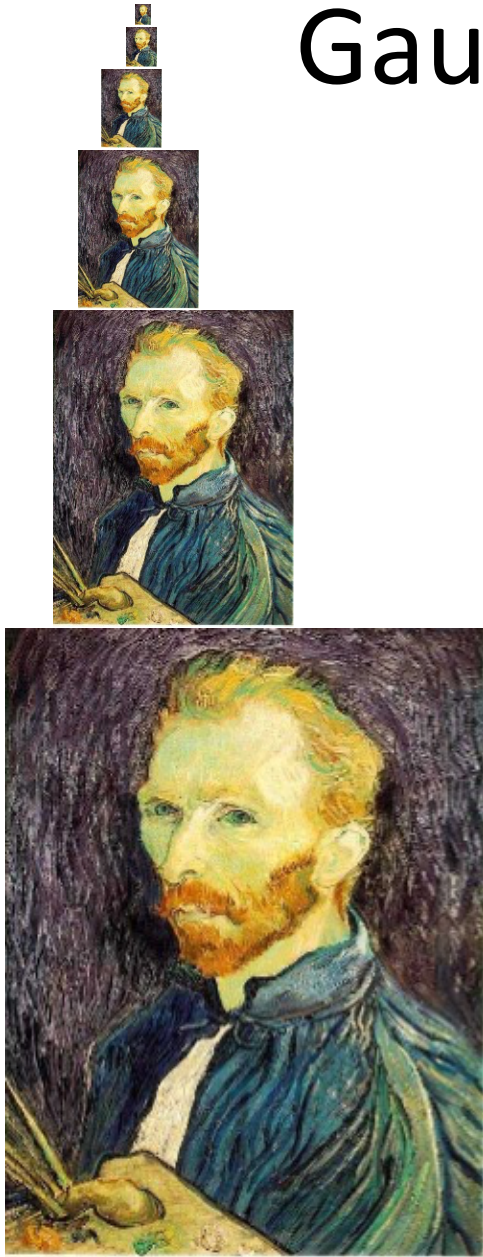

The name of this sequence of subsampled images

Constructing a Gaussian pyramid

Algorithm

repeat:
 filter
 subsample
until min resolution reached

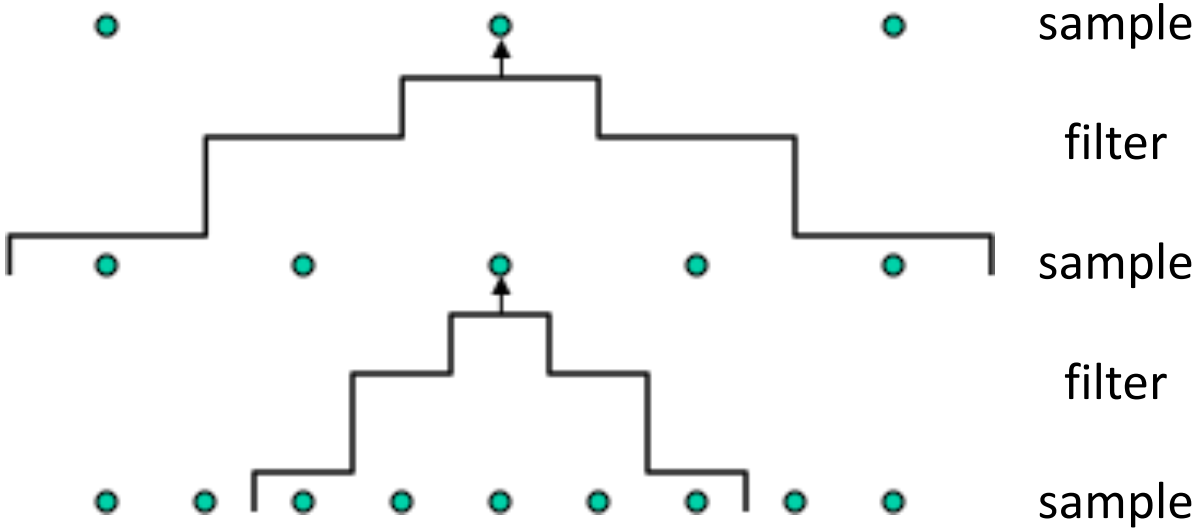

Question: How much bigger than the original image is the whole pyramid?

Constructing a Gaussian pyramid

Algorithm

```
repeat:  
  filter  
  subsample  
until min resolution reached
```

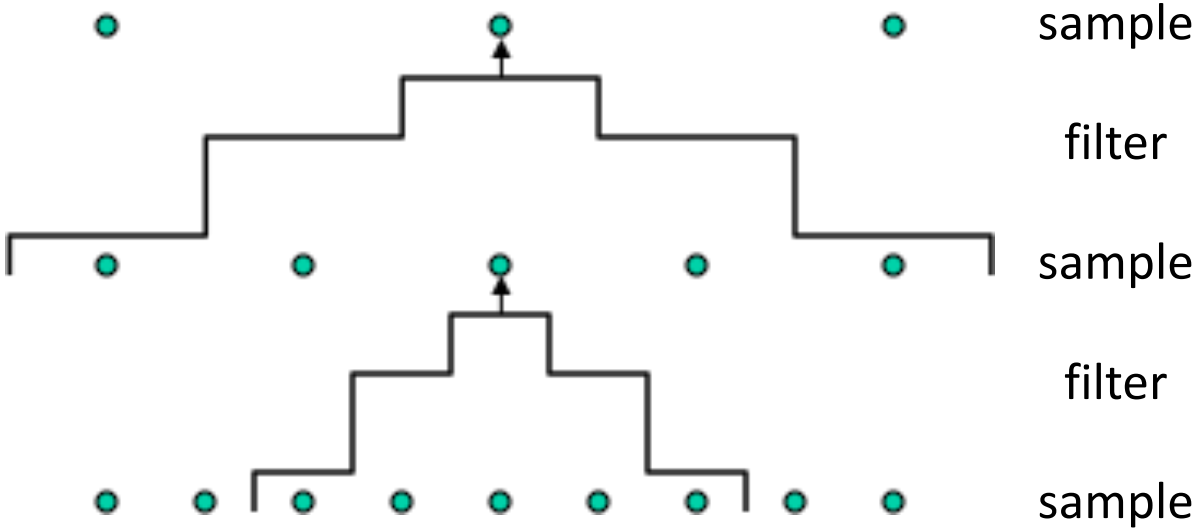

Question: How much bigger than the original image is the whole pyramid?

Answer: Just $\frac{4}{3}$ times the size of the original image! (How did I come up with this number?)

Some properties of the Gaussian pyramid

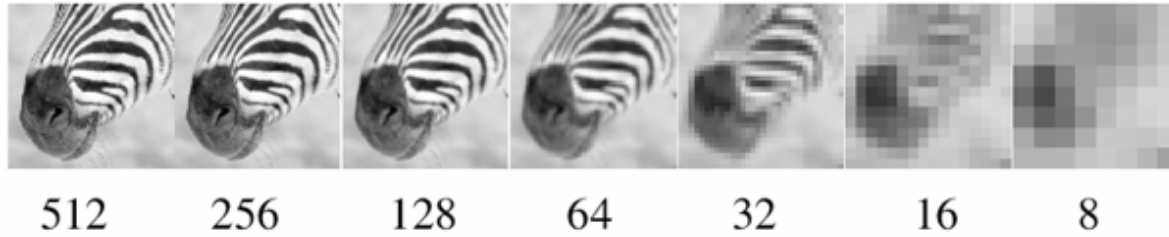

What happens to the details of the image?



Some properties of the Gaussian pyramid

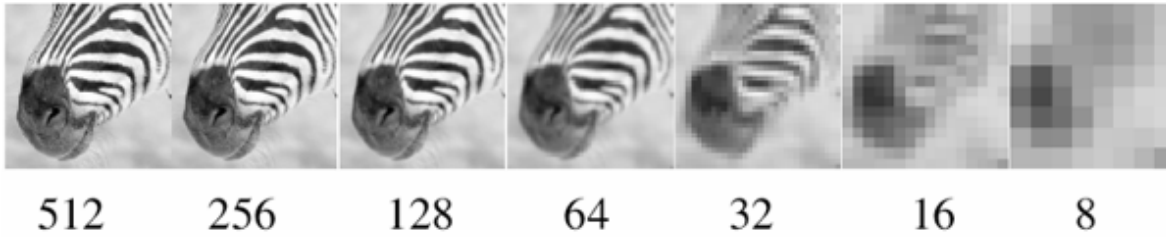

What happens to the details of the image?

- They get smoothed out as we move to higher levels.



Some properties of the Gaussian pyramid

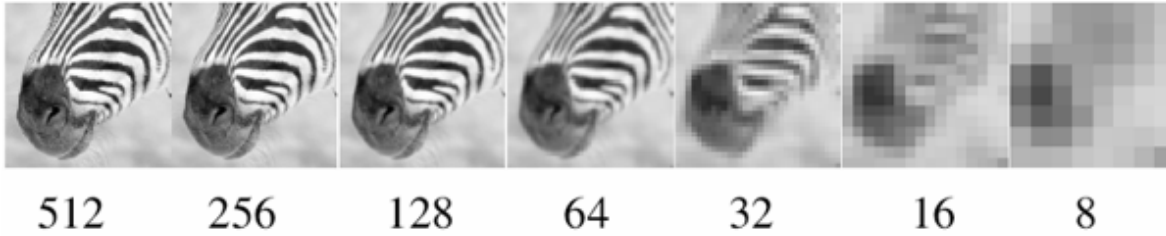

What happens to the details of the image?

- They get smoothed out as we move to higher levels.

What is preserved at the higher levels?

- Mostly large uniform regions in the original image.

How would you reconstruct the original image from the image at the upper level?



Some properties of the Gaussian pyramid

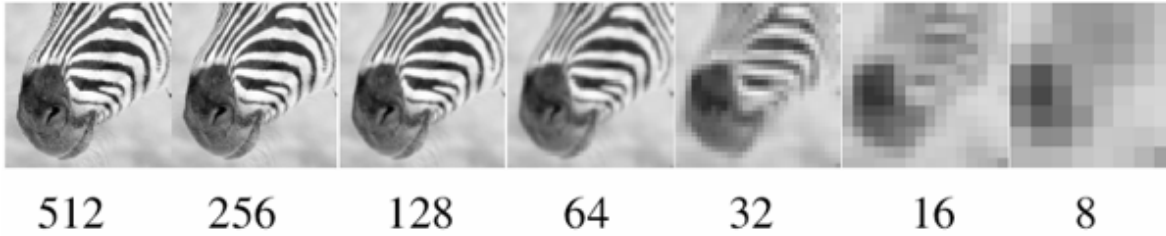

What happens to the details of the image?

- They get smoothed out as we move to higher levels.

What is preserved at the higher levels?

- Mostly large uniform regions in the original image.

How would you reconstruct the original image from the image at the upper level?

- That's not possible.



Blurring is lossy



level 0



level 1 (before downsampling)

What does the residual look like?

Blurring is lossy



level 0



level 1 (before downsampling)



residual

Can we make a pyramid that is lossless?

Laplacian image pyramid

Laplacian image pyramid

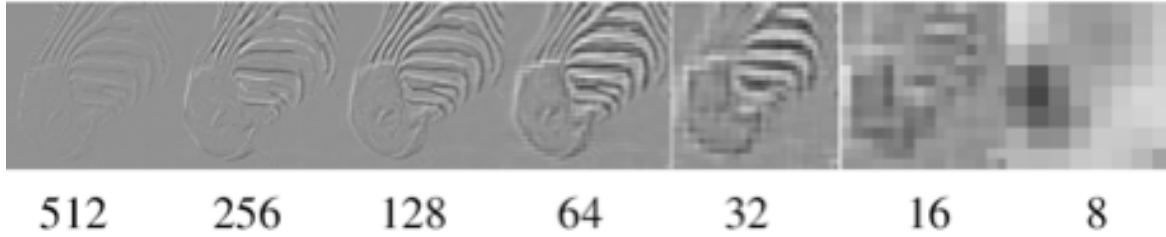

At each level, retain the residuals instead of the blurred images themselves.

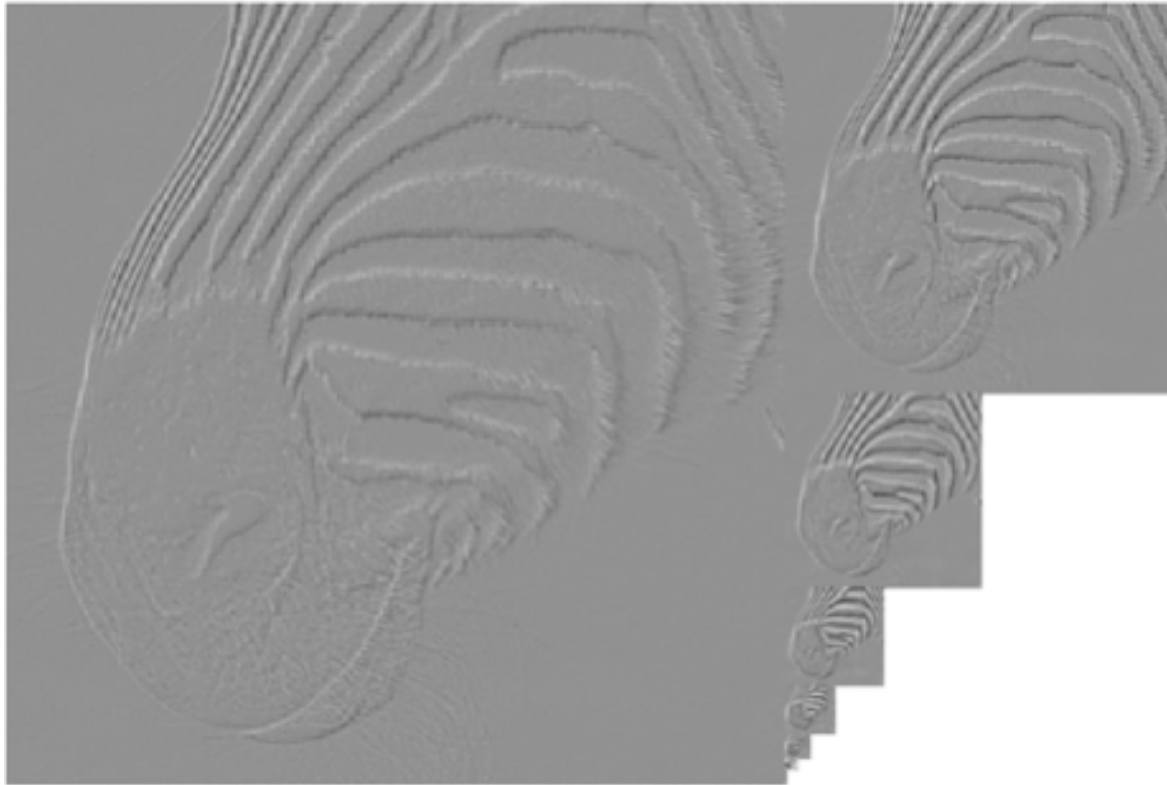

Can we reconstruct the original image using the pyramid?

Laplacian image pyramid

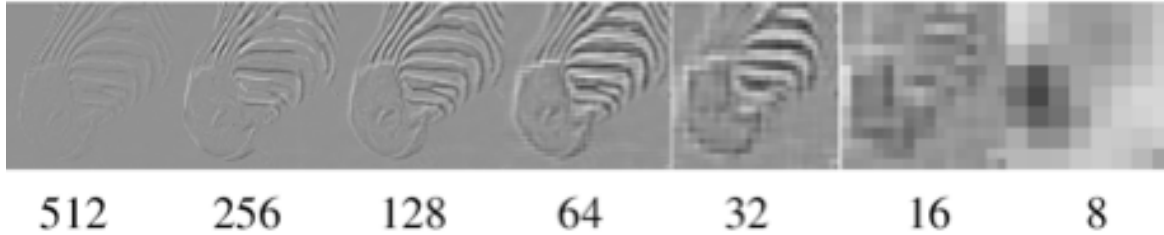

At each level, retain the residuals instead of the blurred images themselves.

Can we reconstruct the original image using the pyramid?

- Yes we can!



What do we need to store to be able to reconstruct the original image?

Let's start by looking at just one level



level 0

=



level 1 (upsampled)

+



residual

Does this mean we need to store both residuals and the blurred copies of the original?

Constructing a Laplacian pyramid

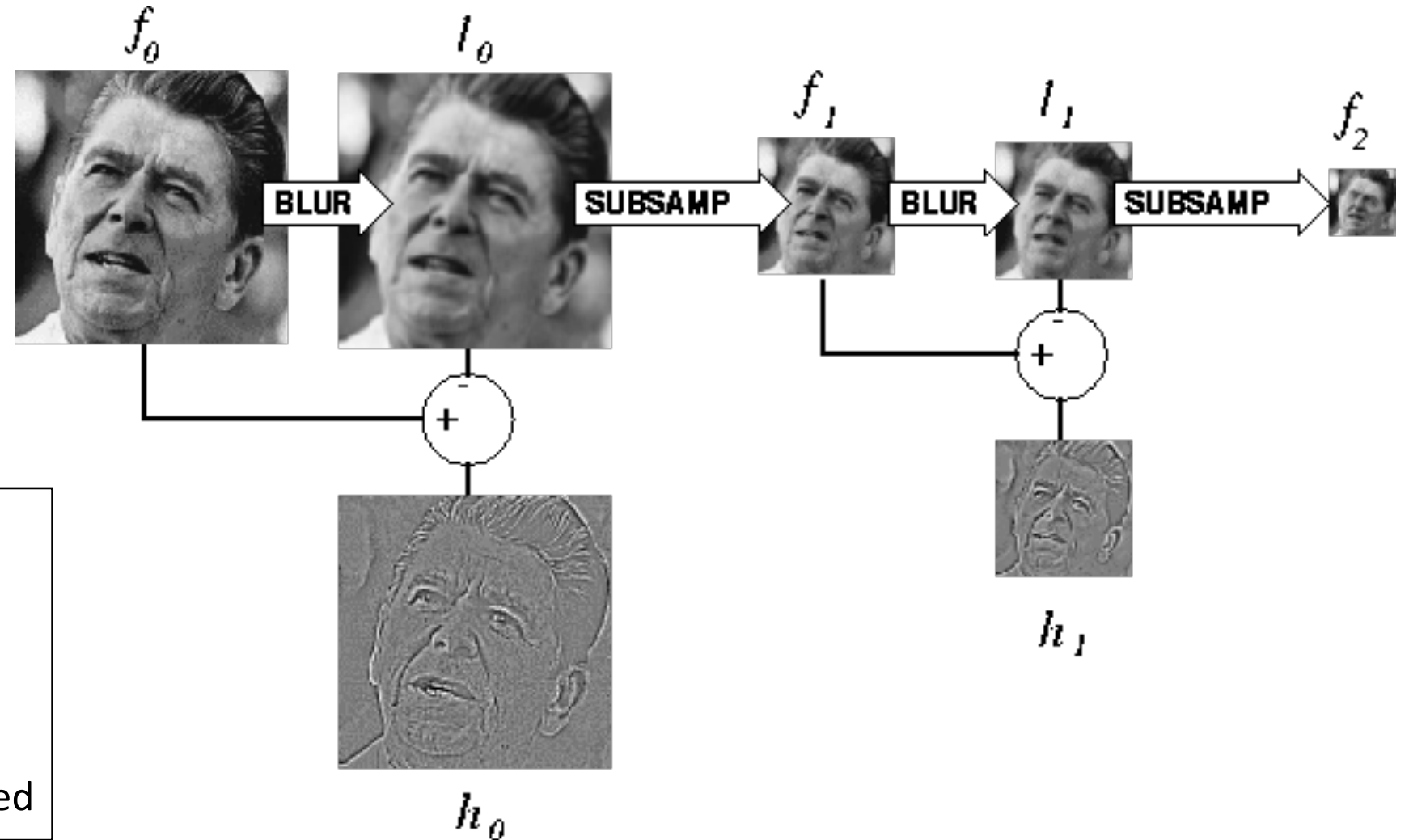

Algorithm

repeat:
 filter
 compute residual
 subsample
until min resolution reached

Constructing a Laplacian pyramid

What is this part?

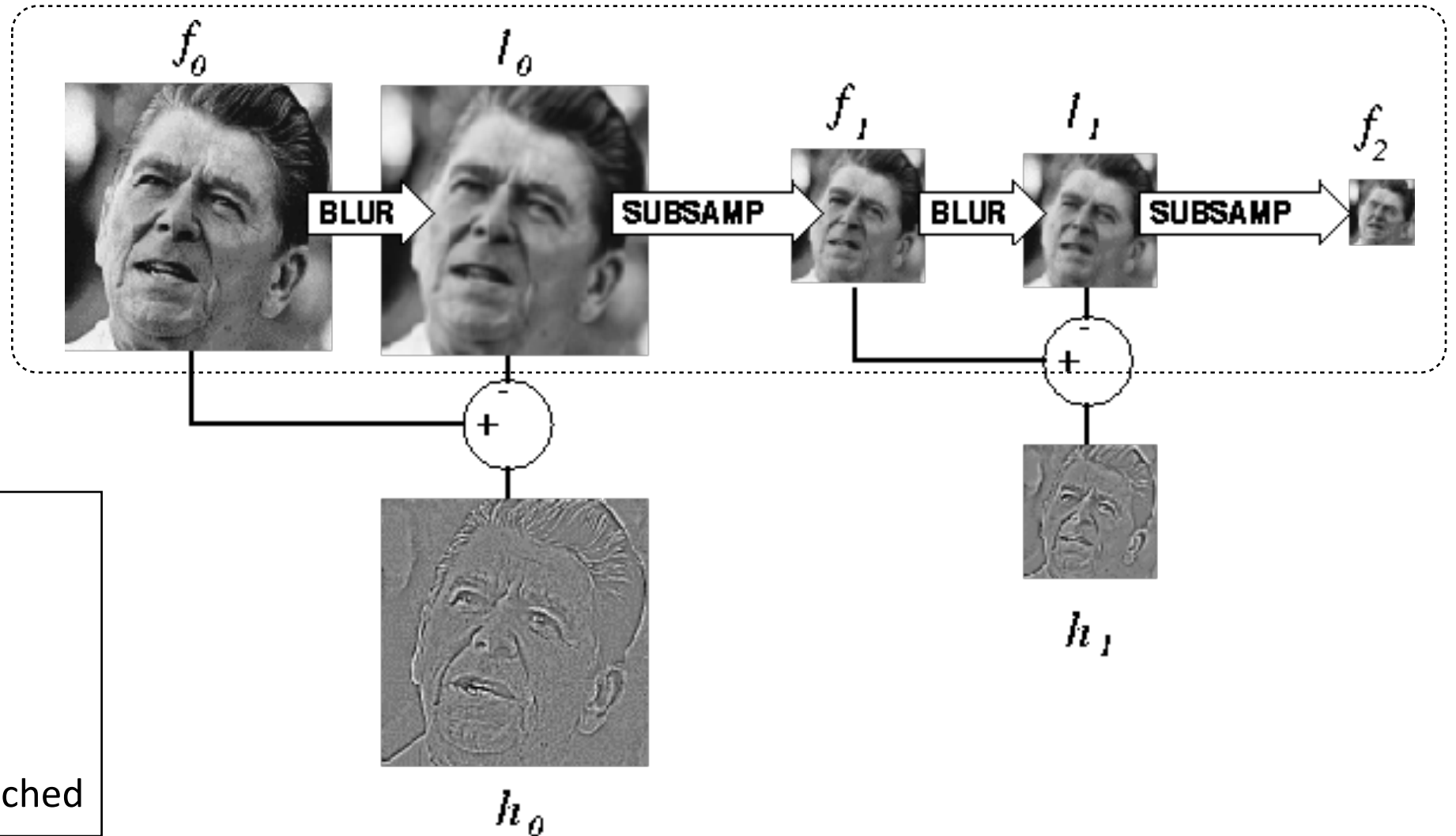

Algorithm

repeat:

filter

compute residual

subsample

until min resolution reached

Constructing a Laplacian pyramid

It's a Gaussian pyramid.

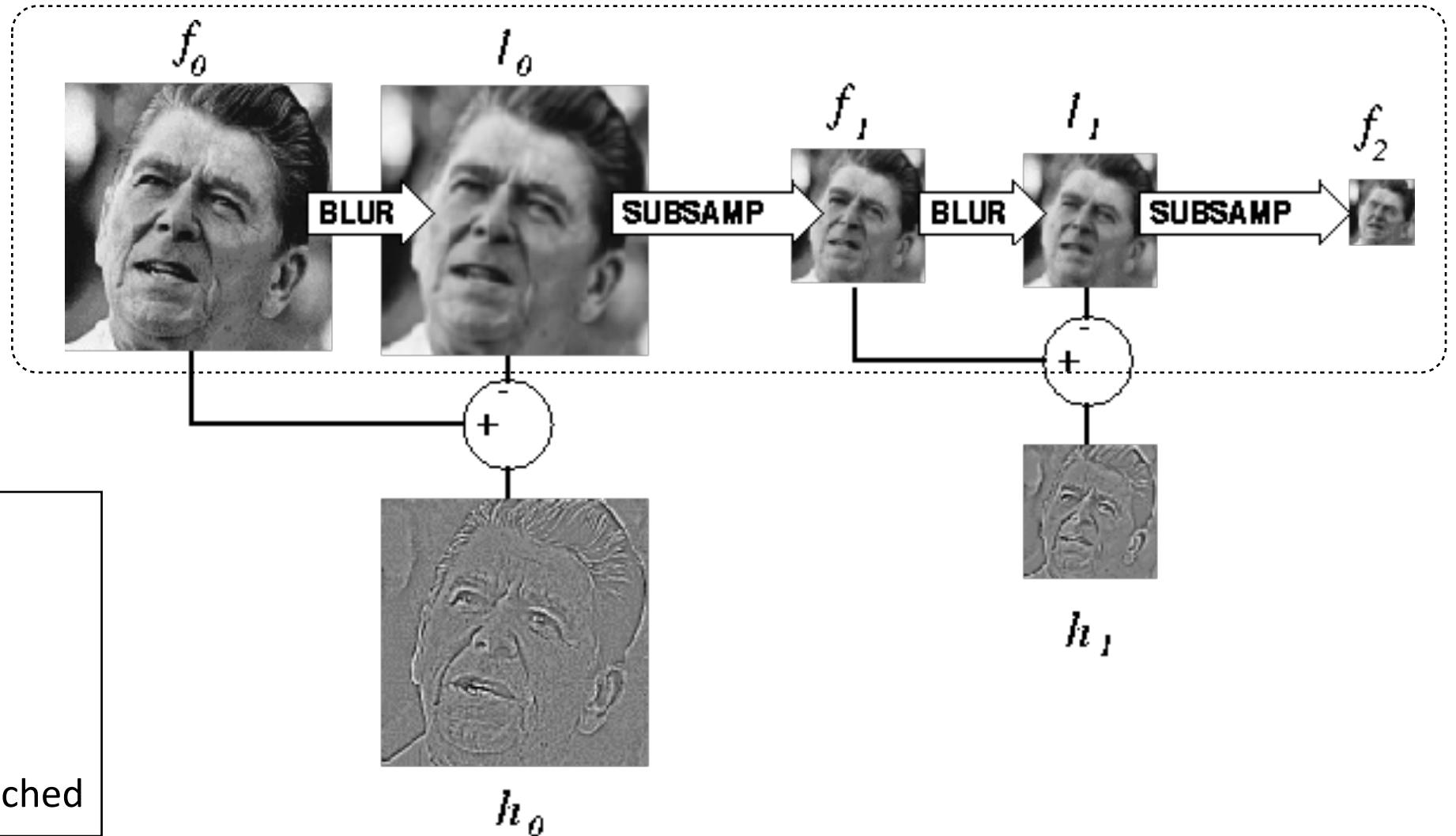

Algorithm

repeat:
 filter
 compute residual
 subsample
until min resolution reached

What do we need to construct the original image?

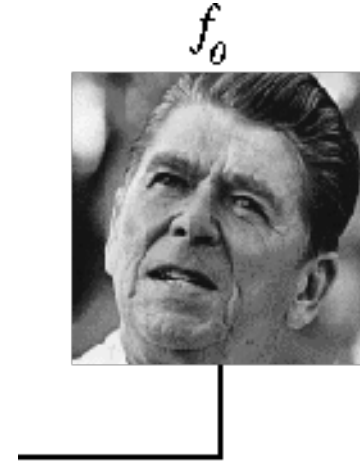

What do we need to construct the original image?

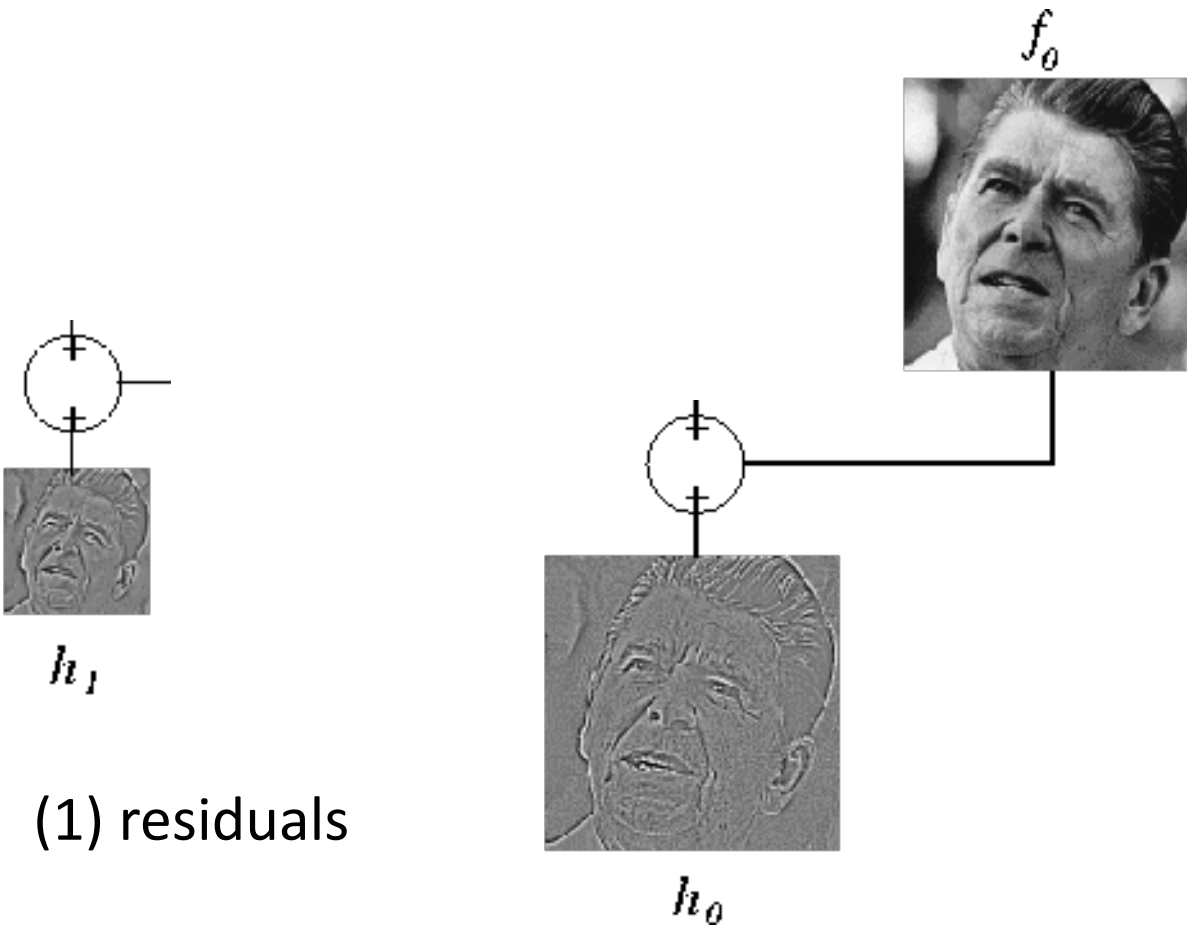

What do we need to construct the original image?

(2) smallest image f_2



h_1

(1) residuals



h_0



f_0

Reconstructing the original image

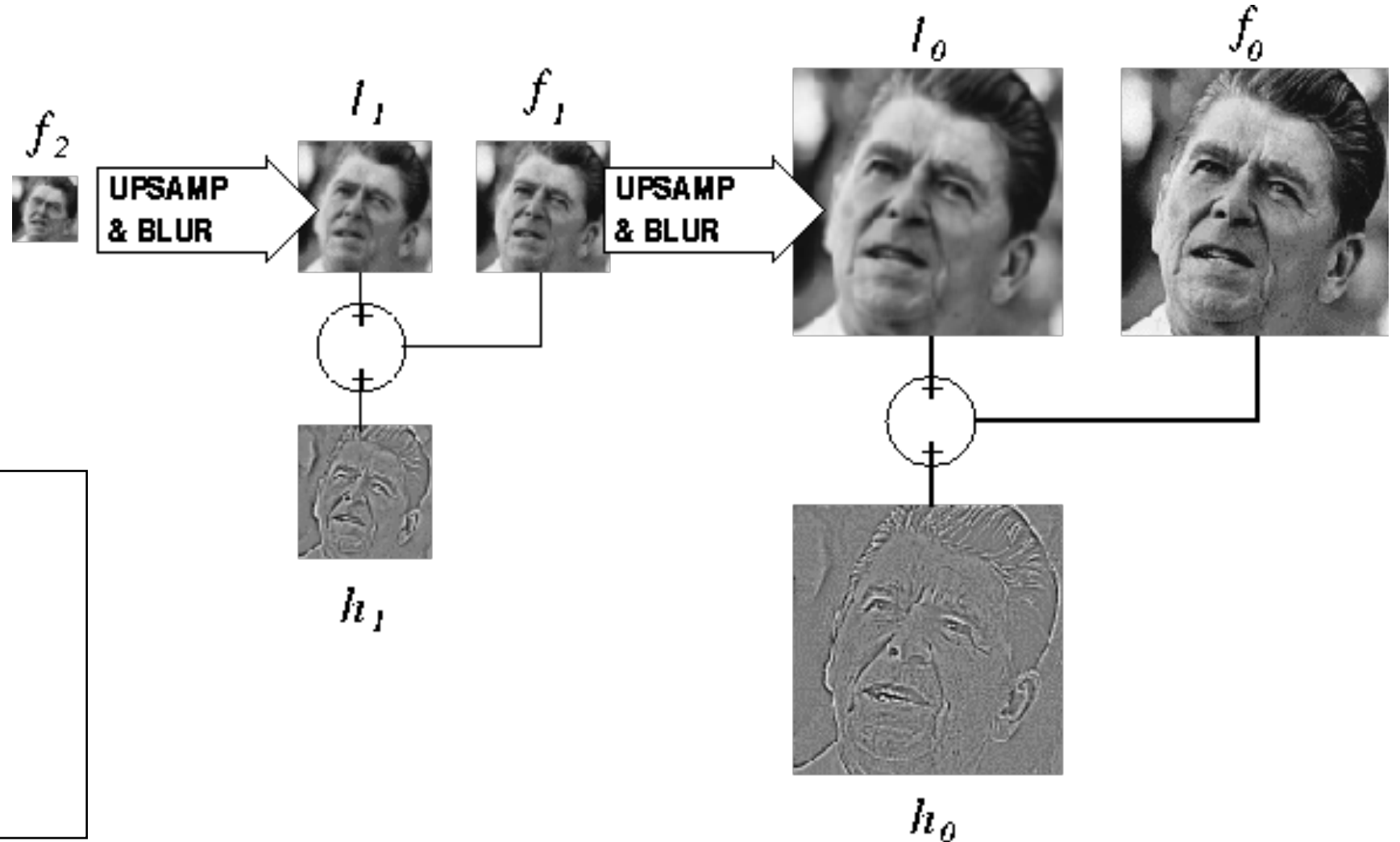

Algorithm

repeat:

 upsample

 sum with residual

until orig resolution

reached

Gaussian vs Laplacian Pyramid

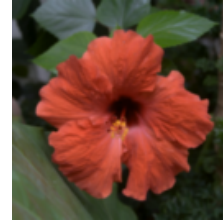

Shown in opposite order for space.

Which one takes more space to store?

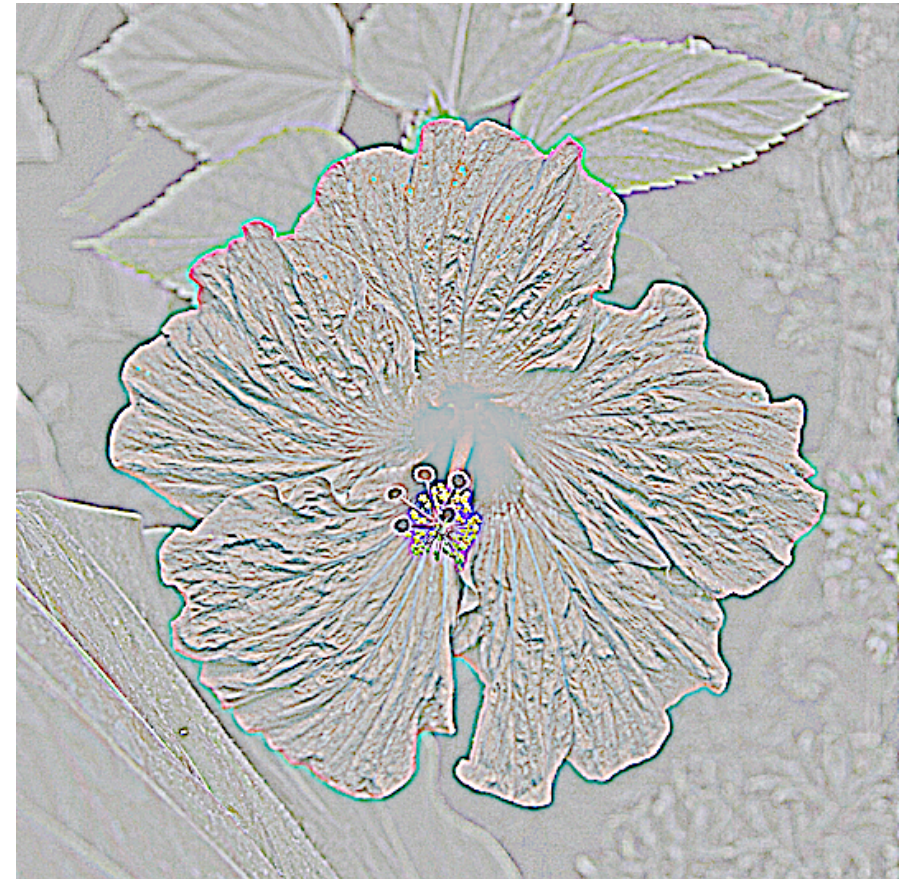
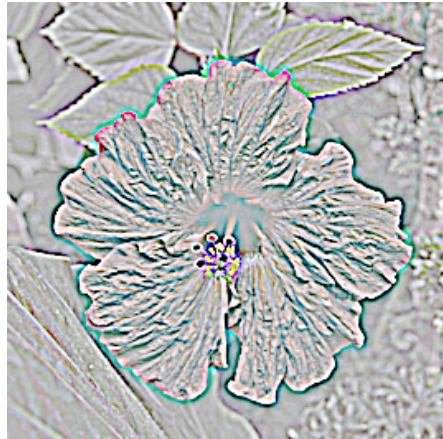
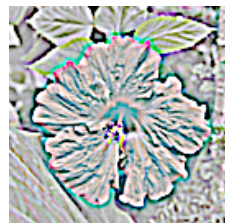

Why is it called a Laplacian pyramid?

Reminder: Laplacian of Gaussian (LoG) filter

As with derivative, we can combine Laplace filtering with Gaussian filtering

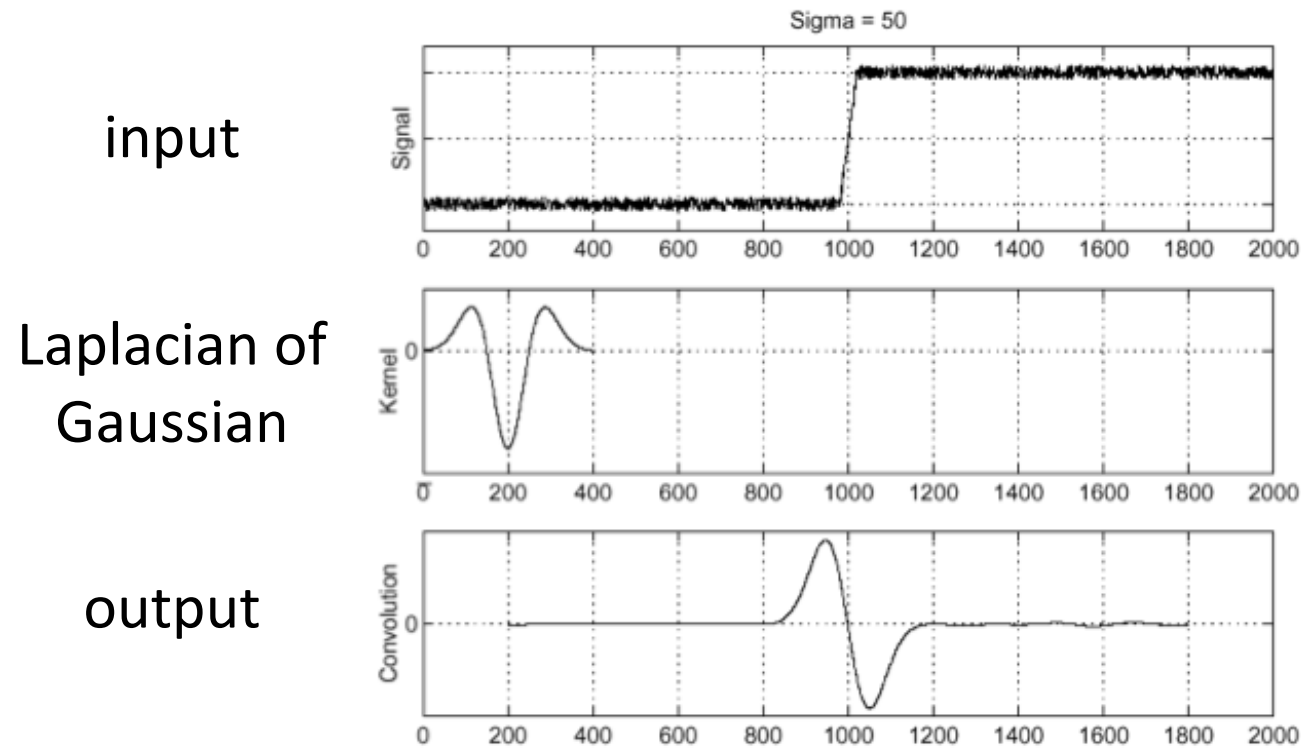

“zero crossings” at edges

Why is it called a Laplacian pyramid?

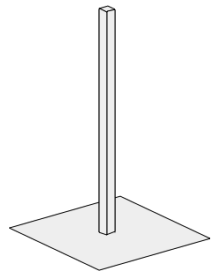

unit

-

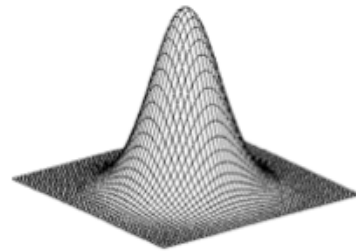

Gaussian

≈

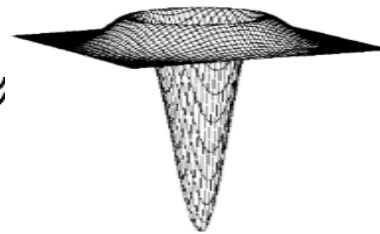

Laplacian

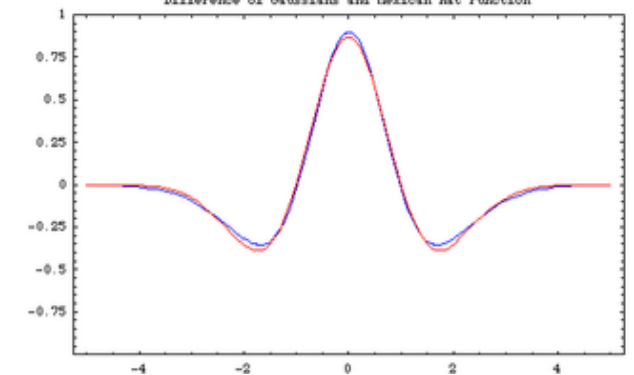
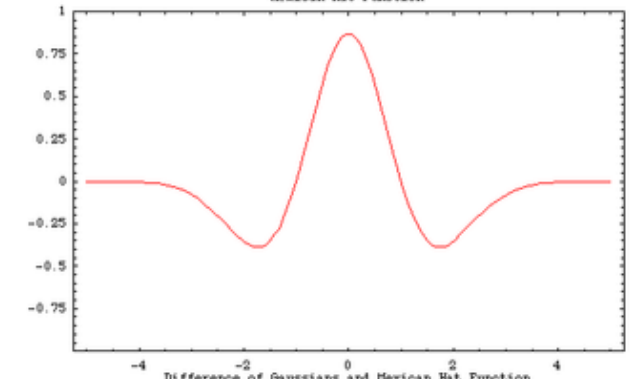
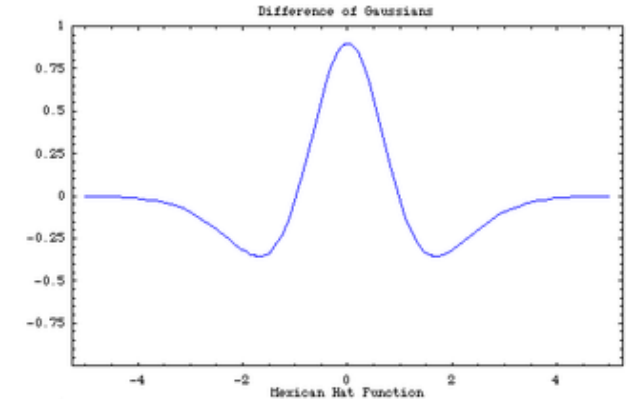

Difference of Gaussians approximates the Laplacian

Why Reagan?

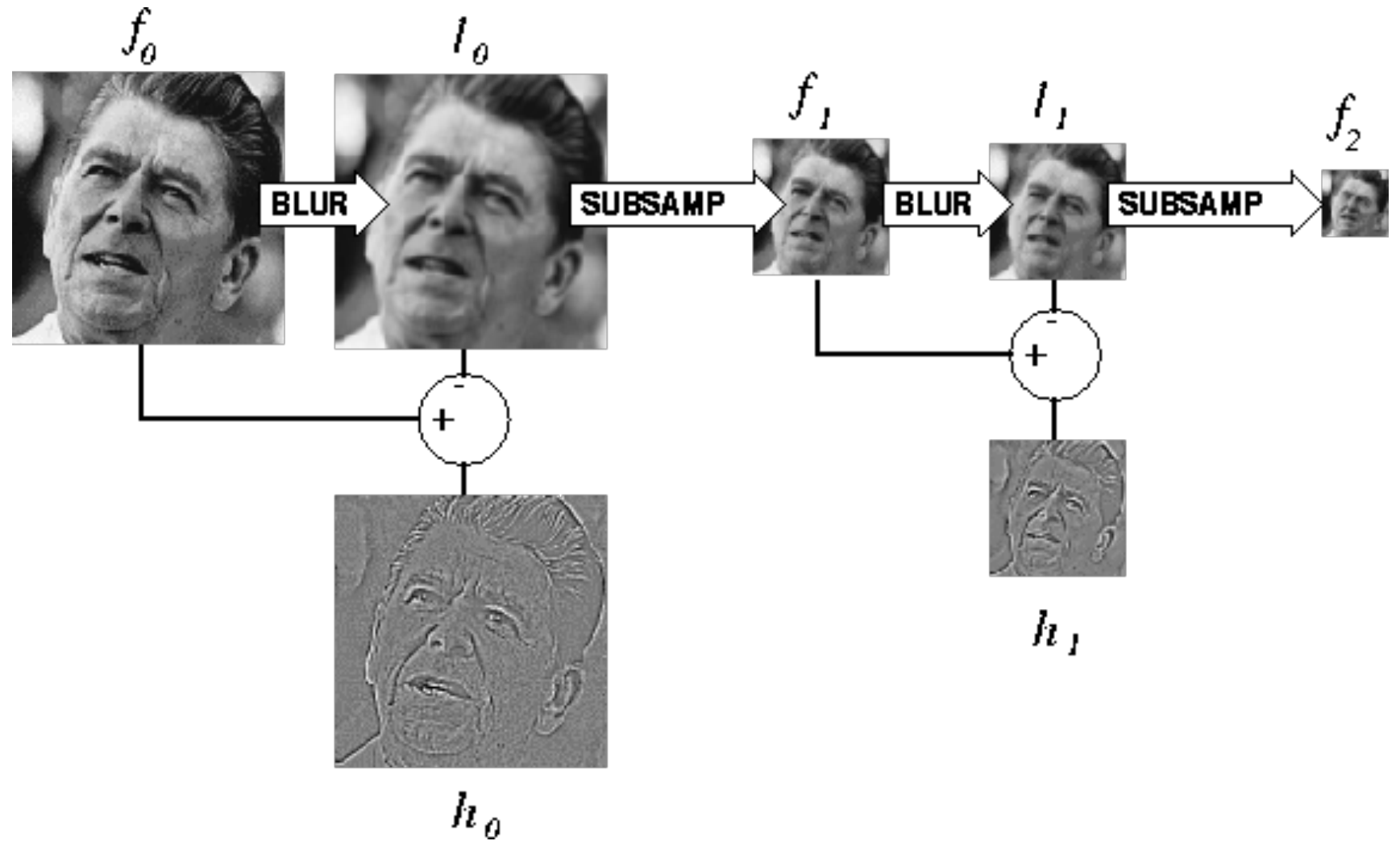

Why Reagan?

Ronald Reagan was
President when the
Laplacian pyramid
was invented

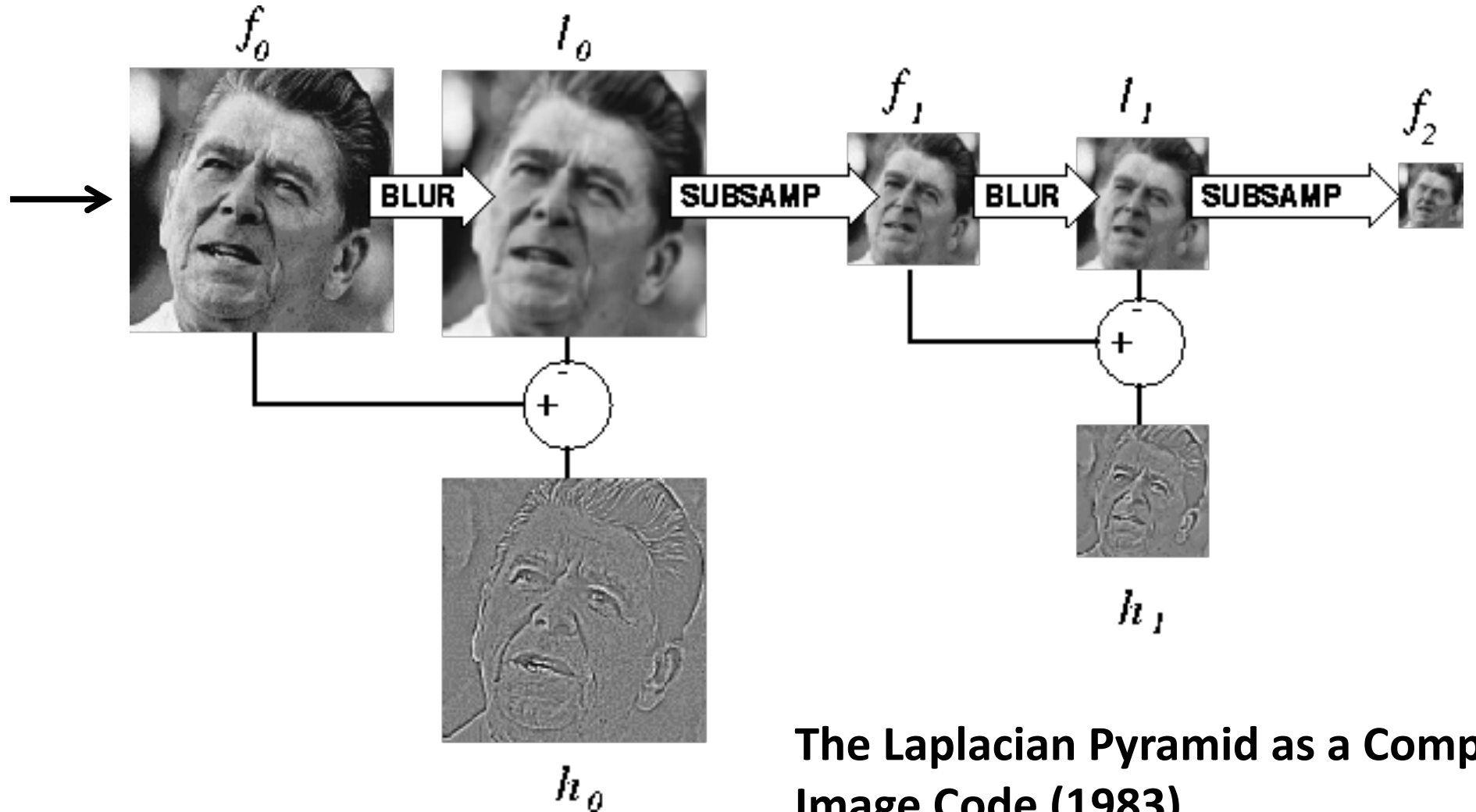

**The Laplacian Pyramid as a Compact
Image Code (1983)**

Peter J. Burt , Edward H. Adelson

Still used extensively



Still used extensively



foreground details enhanced, background details reduced



input image



user-provided mask

Other types of pyramids

Steerable pyramid: At each level keep multiple versions, one for each direction.



Wavelets: Huge area in image processing (see 18-793).



What are image pyramids used for?

image compression



multi-scale texture mapping

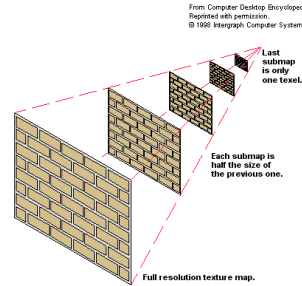
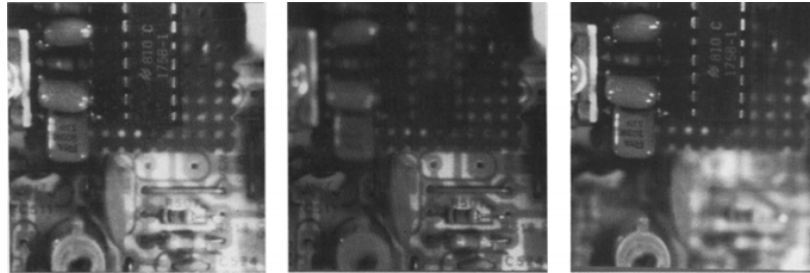

image blending



focal stack compositing



denoising

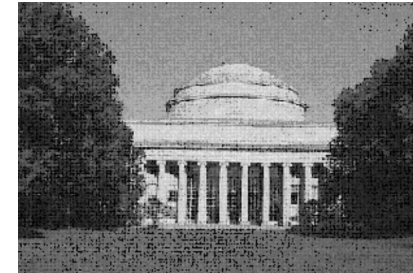

multi-scale detection



multi-scale registration

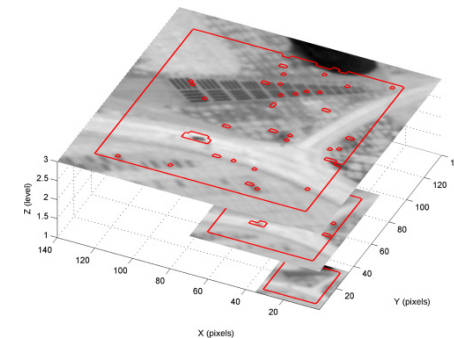

Some history

Who is this guy?



What is he famous for?



Jean Baptiste Joseph Fourier
(1768-1830)

What is he famous for?



Jean Baptiste Joseph Fourier
(1768-1830)

The Fourier series claim (1807):

'Any univariate function can be rewritten as a weighted sum of sines and cosines of different frequencies.'

... and apparently also for the discovery
of the greenhouse effect

Is this claim true?



Jean Baptiste Joseph Fourier
(1768-1830)

The Fourier series claim (1807):

'Any univariate function can be rewritten as a weighted sum of sines and cosines of different frequencies.'

Is this claim true?



Jean Baptiste Joseph Fourier
(1768-1830)

The Fourier series claim (1807):

'Any univariate function can be rewritten as a weighted sum of sines and cosines of different frequencies.'

Well, almost.

- The theorem requires additional conditions.
- Close enough to be named after him.
- Very surprising result at the time.

Is this claim true?



Jean Baptiste Joseph Fourier
(1768-1830)

The Fourier series claim (1807):

'Any univariate function can be rewritten as a weighted sum of sines and cosines of different frequencies.'

Well, almost.

- The theorem requires additional conditions.
- Close enough to be named after him.
- Very surprising result at the time.



Malus

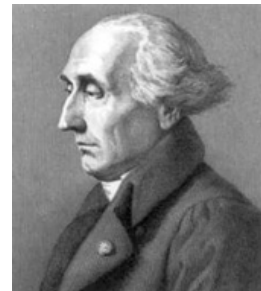

Lagrange

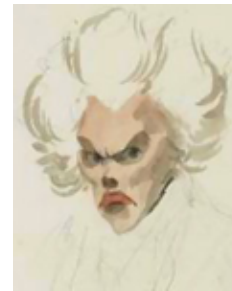

Legendre



Laplace

The committee examining his paper had expressed skepticism, in part due to not so rigorous proofs

Fourier series

Basic building block

$$A \sin(\omega x + \phi)$$

Fourier's claim: Add enough of these to get any *periodic* signal you want!

Basic building block

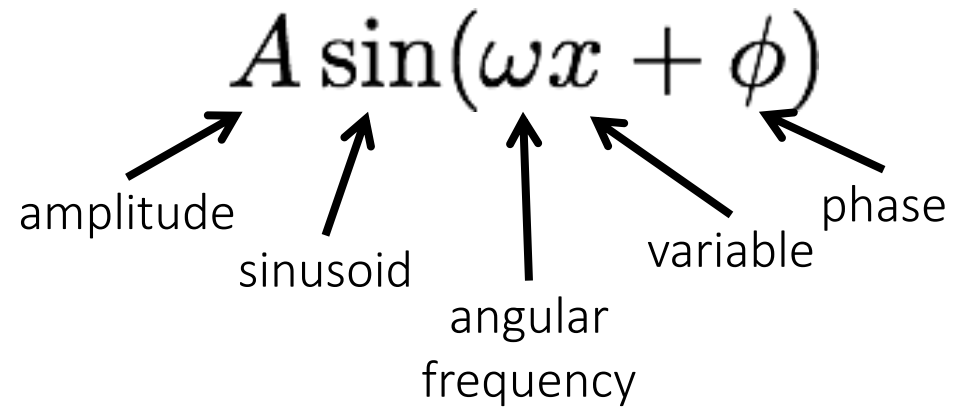
$$A \sin(\omega x + \phi)$$

The diagram shows the equation $A \sin(\omega x + \phi)$ with five arrows pointing to its components: 'amplitude' points to A , 'sinusoid' points to \sin , 'angular frequency' points to ω , 'variable' points to x , and 'phase' points to ϕ .

Fourier's claim: Add enough of these to get any *periodic* signal you want!

Examples

How would you generate this function?

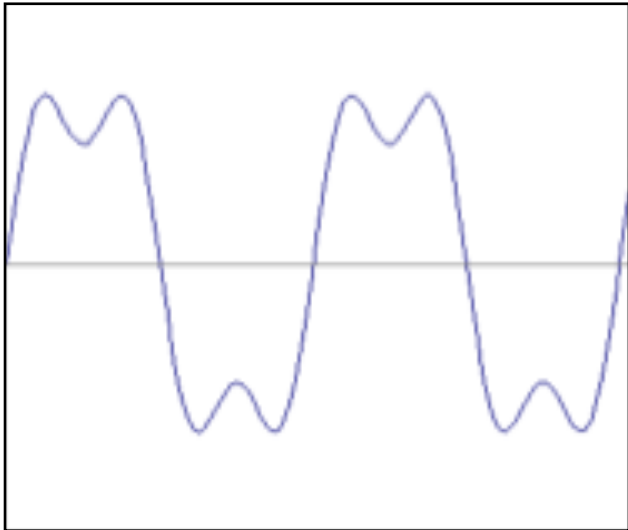

=

?

+

?

Examples

How would you generate this function?

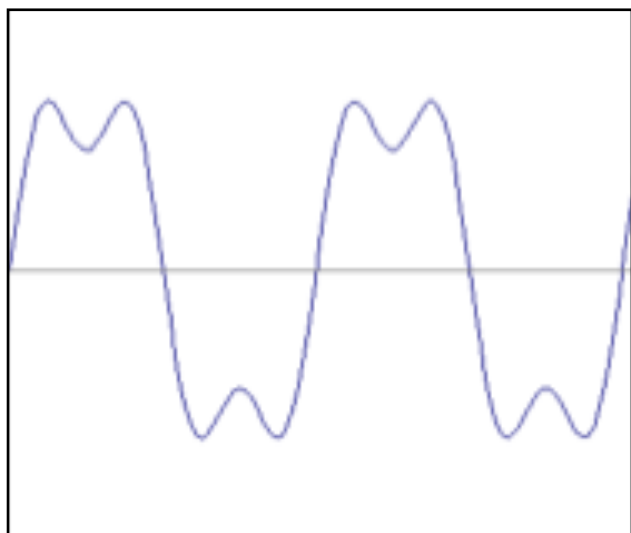

=

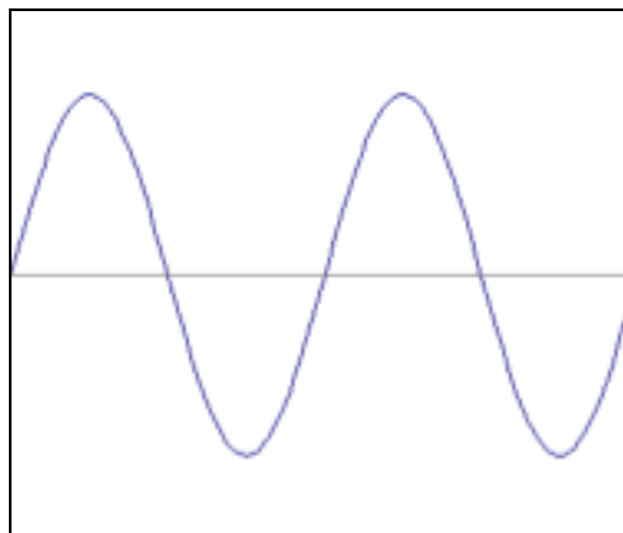

$\sin(2\pi x)$

+

?

Examples

How would you generate this function?

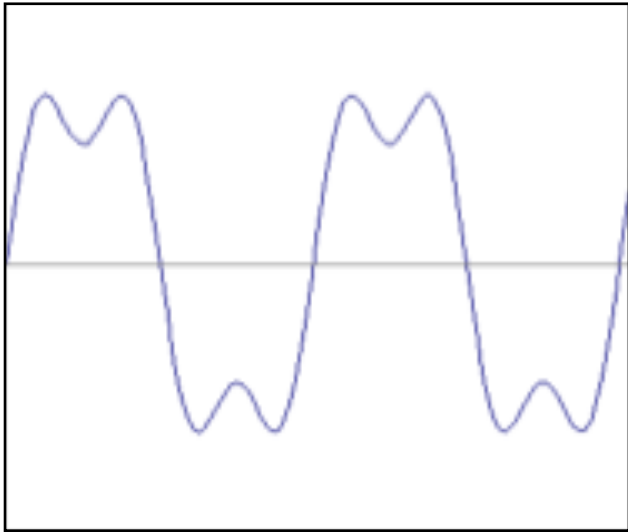

=

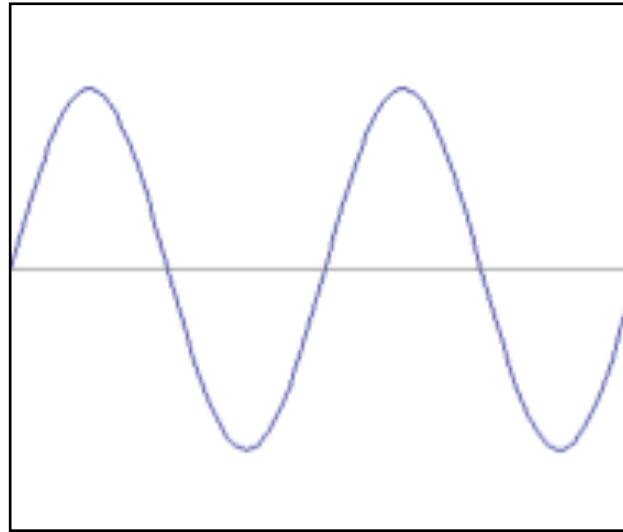

+

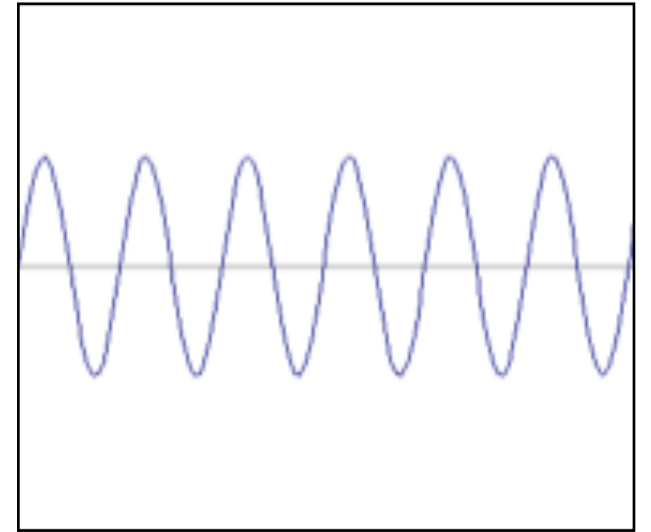

$$f(x) = \sin(2\pi x) + \frac{1}{3} \sin(2\pi 3x)$$

$$\sin(2\pi x)$$

$$\frac{1}{3} \sin(2\pi 3x)$$

Examples

How would you generate this function?

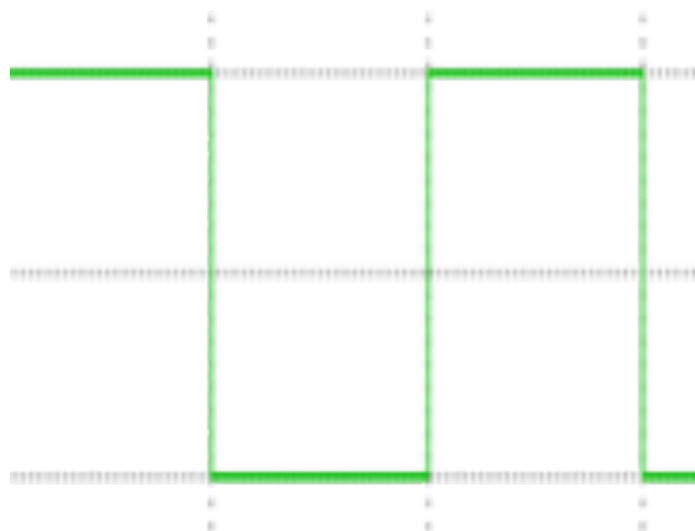

square wave

$$= \quad ? \quad + \quad ?$$

Examples

How would you generate this function?

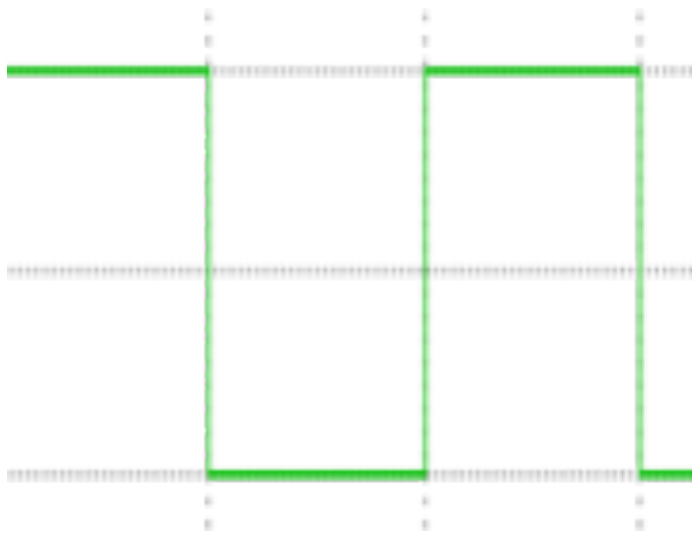

square wave

\approx

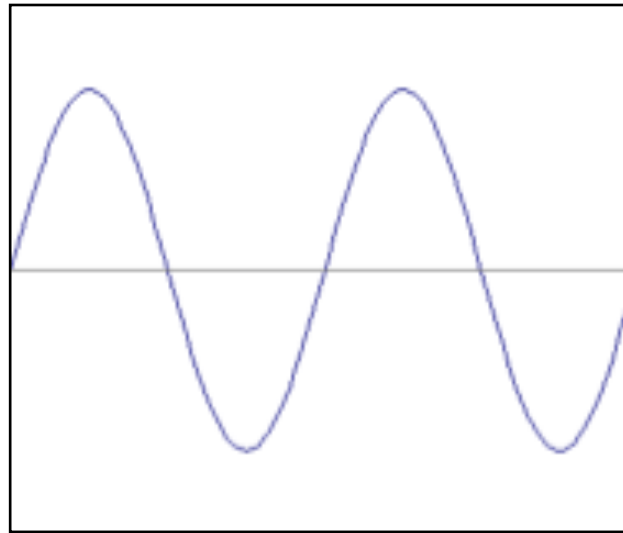

+

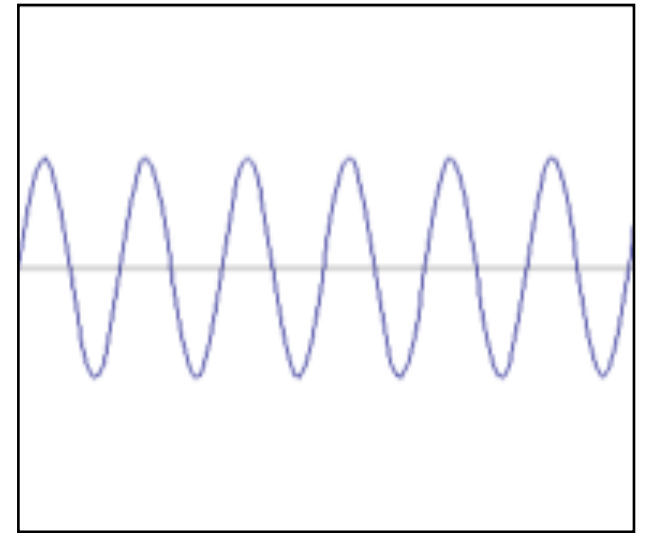

$=$

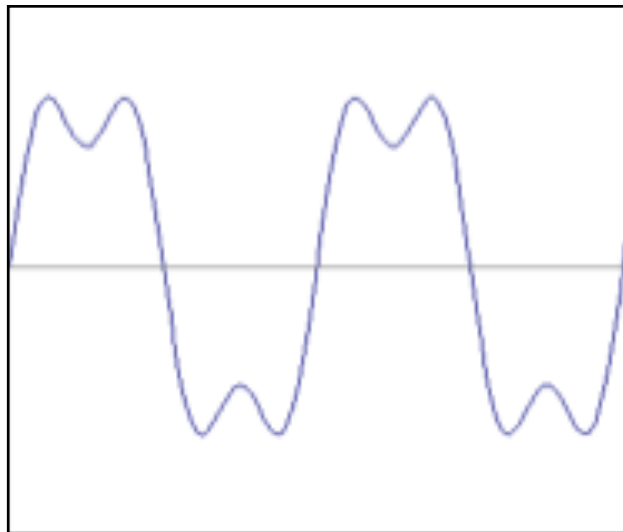

Examples

How would you generate this function?

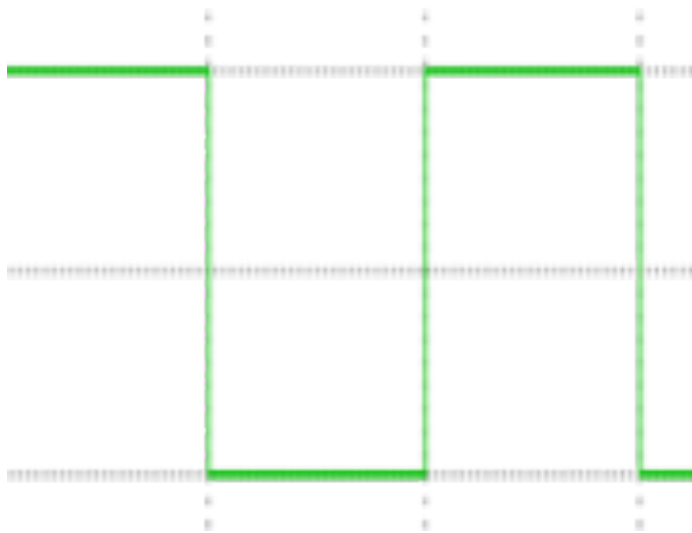

square wave

\approx

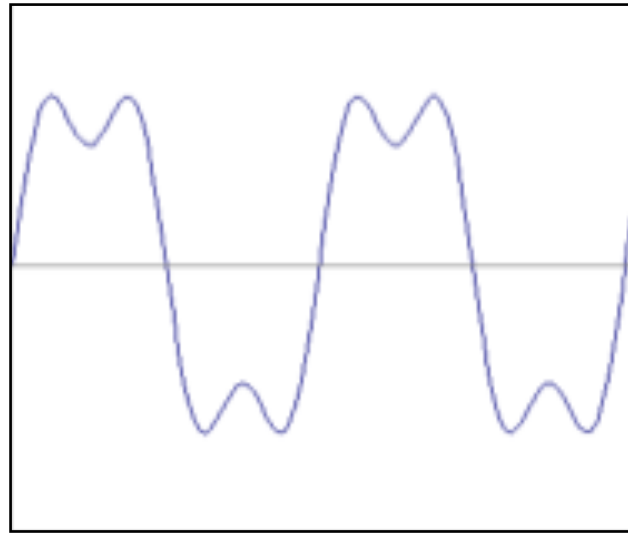

+

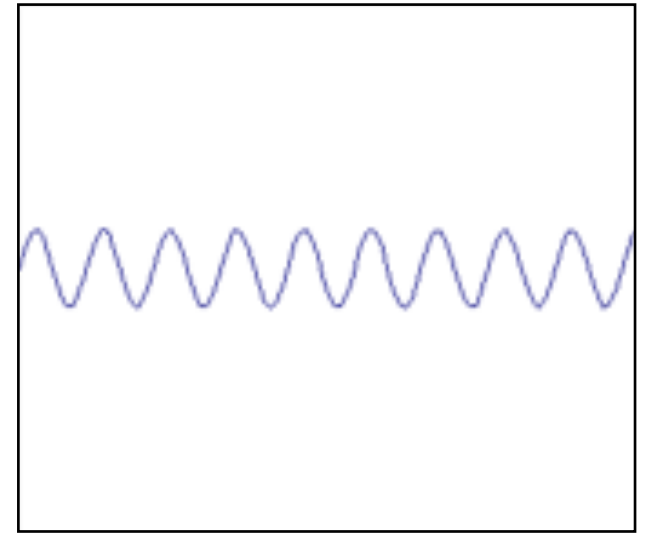

$=$

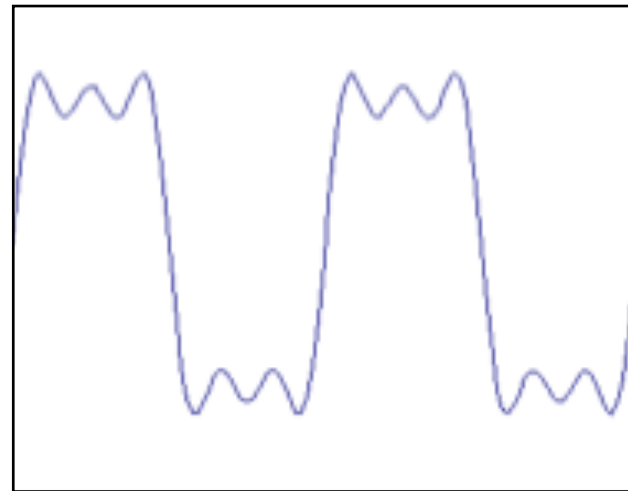

Examples

How would you generate this function?

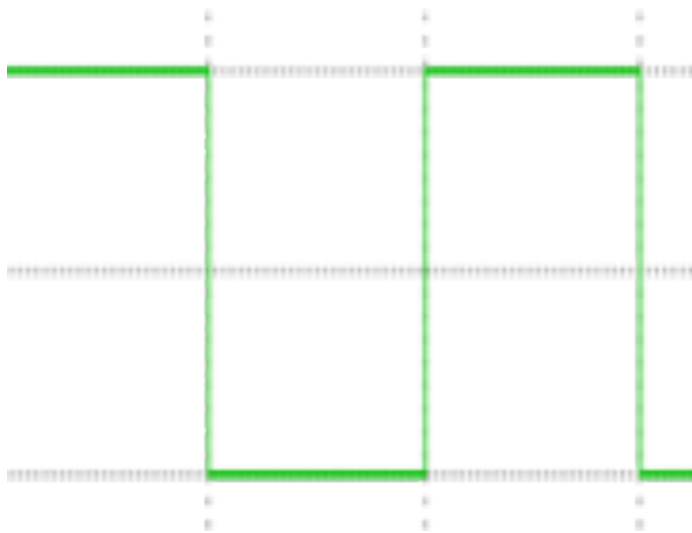

square wave

\approx

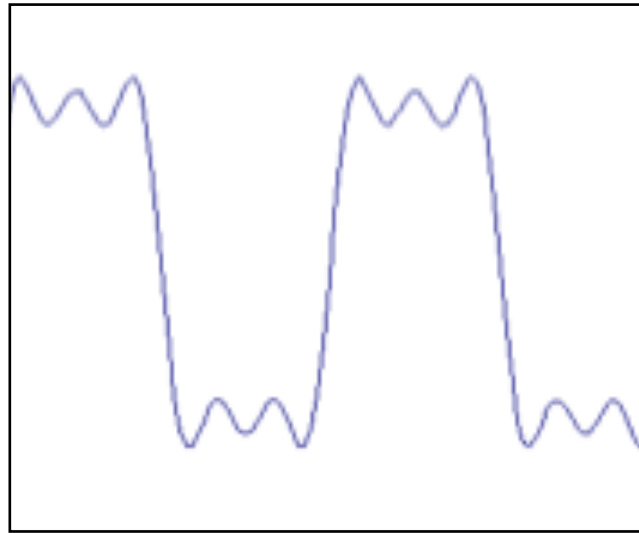

+

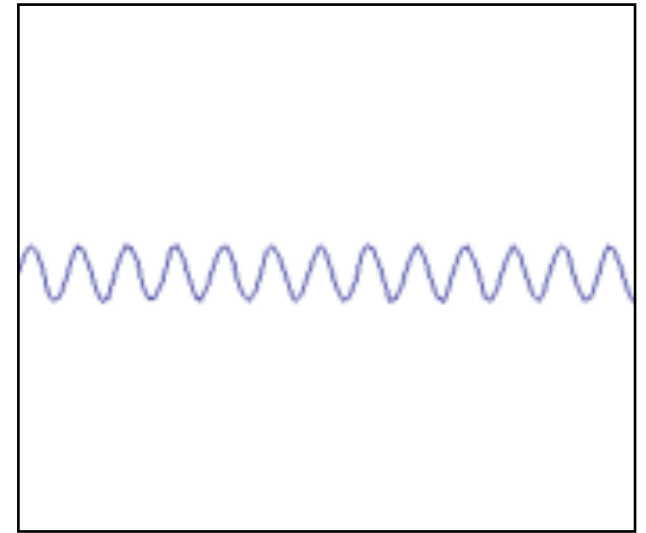

$=$

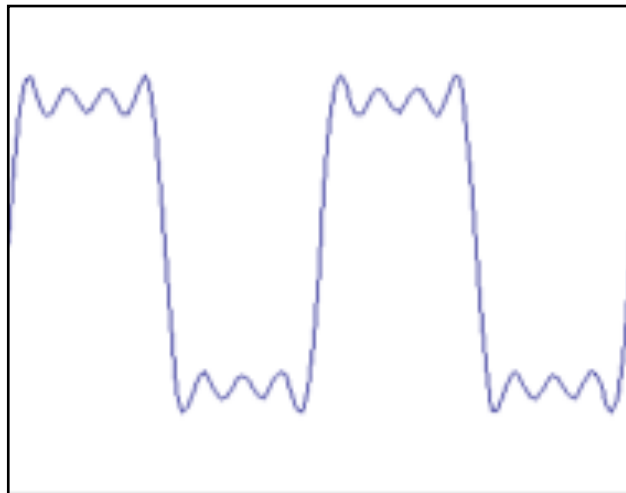

Examples

How would you generate this function?

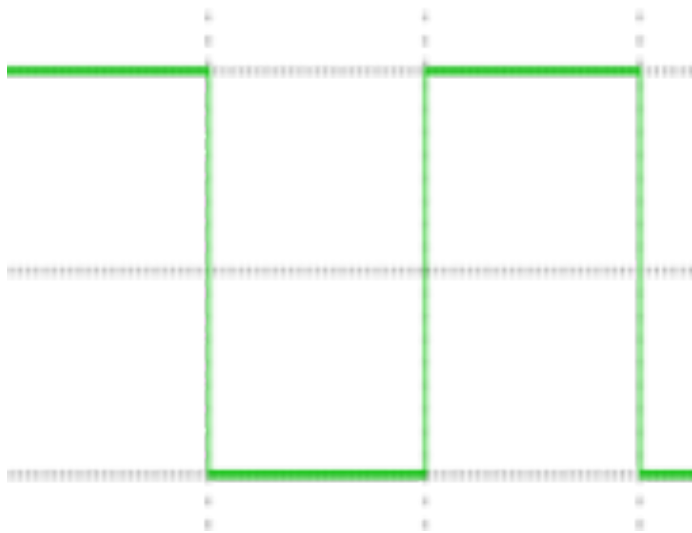

square wave

\approx



+

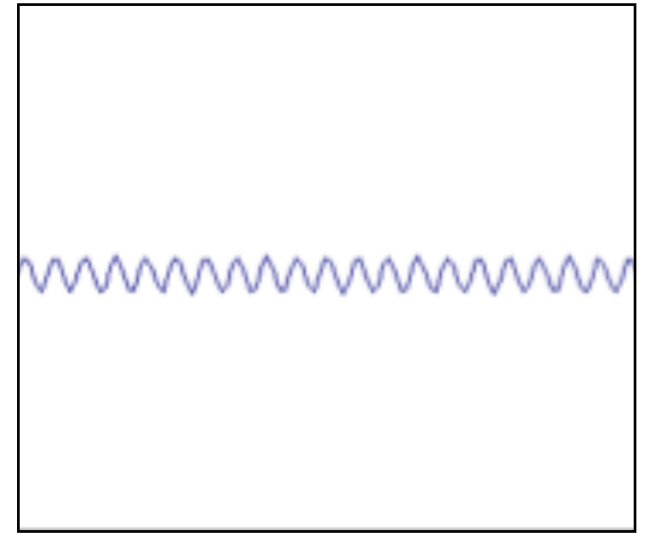

$=$



Examples

How would you generate this function?

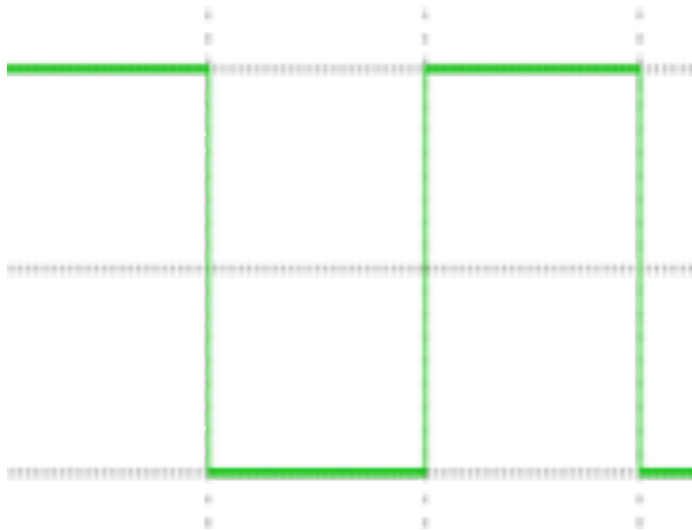

square wave

\approx



+

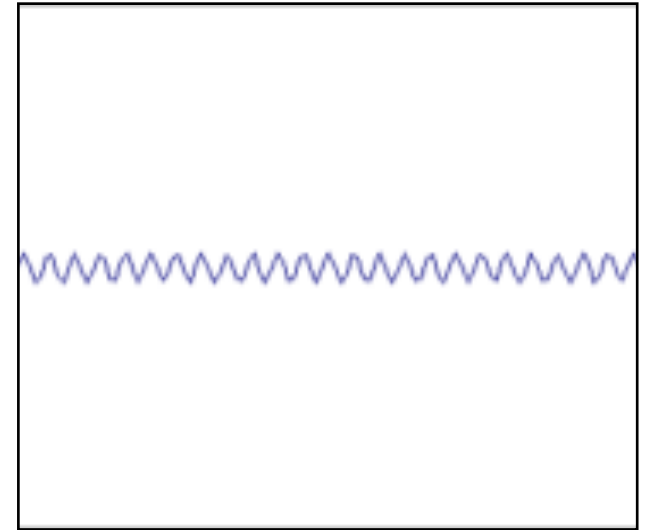

$=$

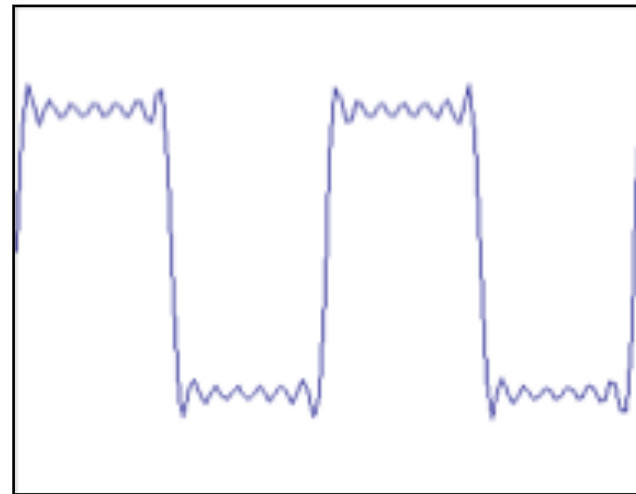

How would you express this mathematically?

Examples

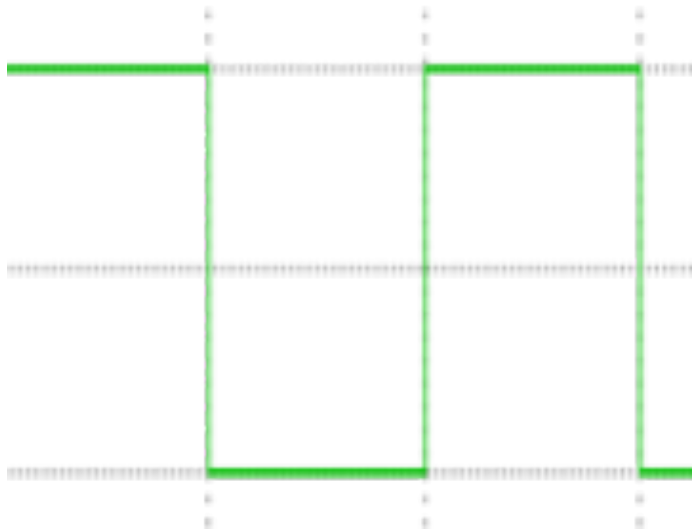

square wave

=

$$A \sum_{k=1}^{\infty} \frac{1}{k} \sin(2\pi kx)$$

infinite sum of sine waves

How would you visualize this in the frequency domain?

Examples

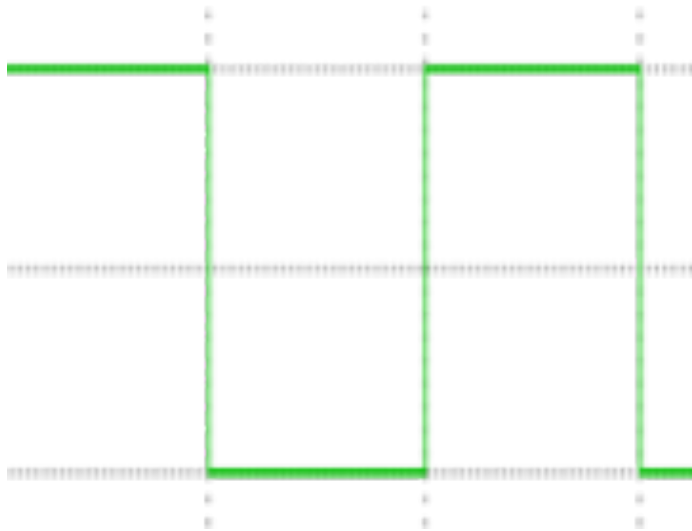

square wave

=

$$A \sum_{k=1}^{\infty} \frac{1}{k} \sin(2\pi kx)$$

infinite sum of sine waves

magnitude

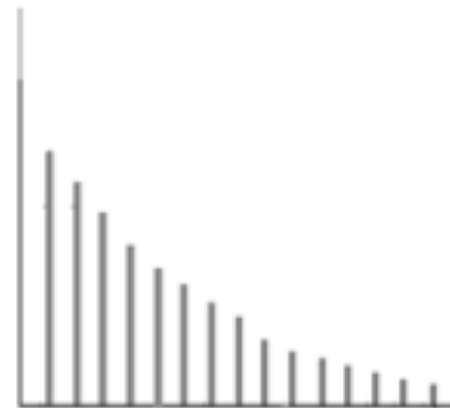

frequency

Frequency domain

Visualizing the frequency spectrum

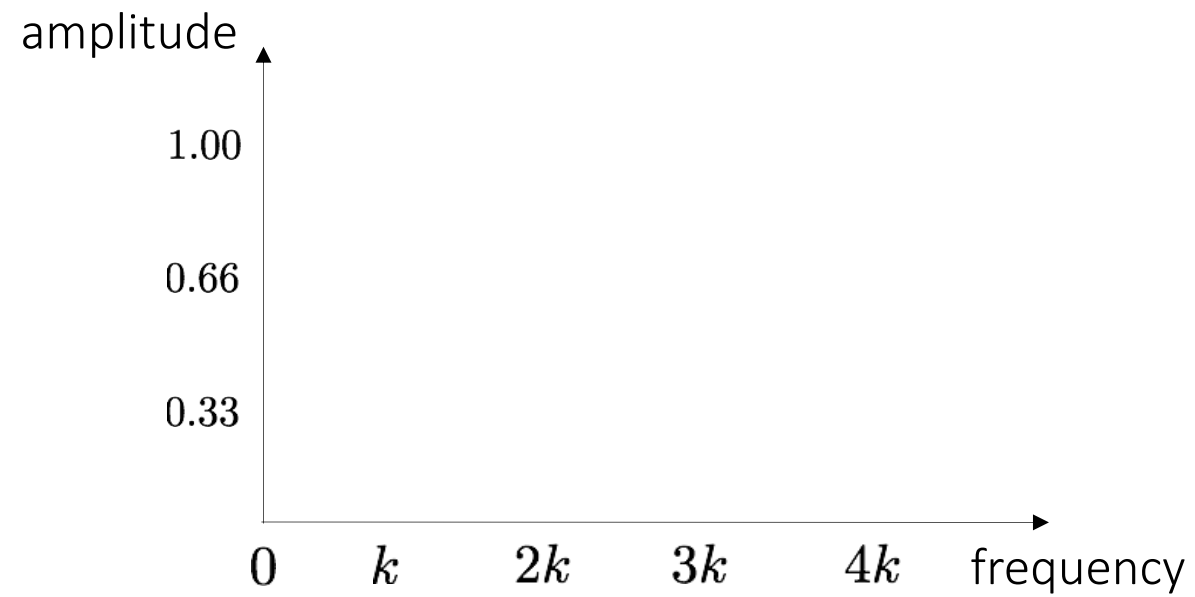

Visualizing the frequency spectrum

Recall the temporal domain visualization

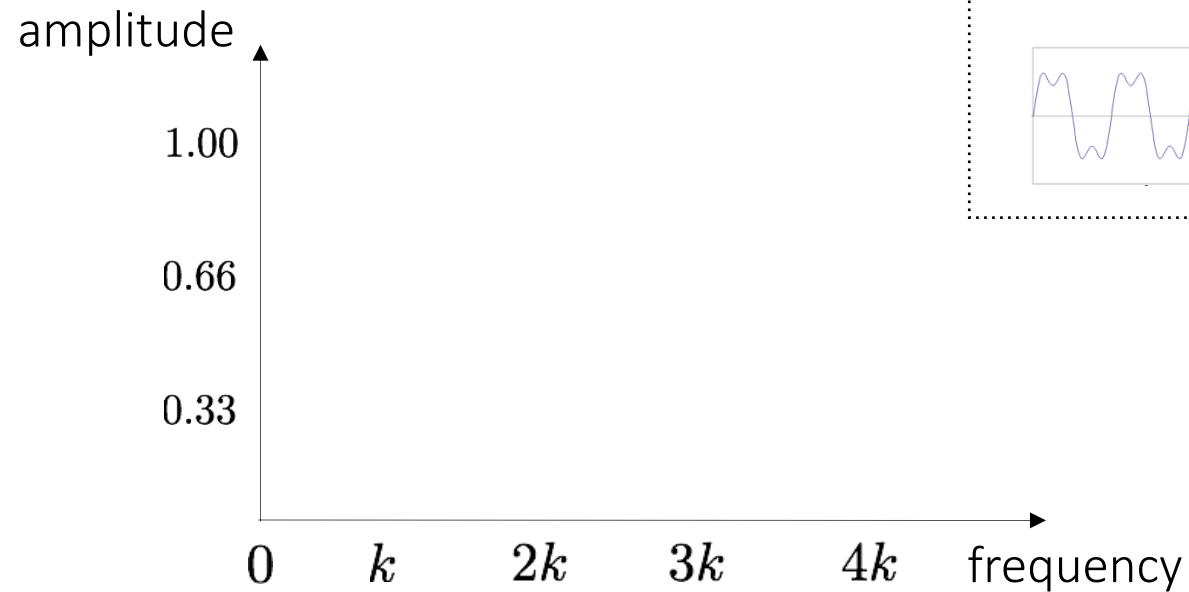

$$f(x) = \sin(2\pi kx) + \frac{1}{3} \sin(2\pi 3kx)$$



Visualizing the frequency spectrum

Recall the temporal domain visualization

$$f(x) = \sin(2\pi kx) + \frac{1}{3} \sin(2\pi 3kx)$$

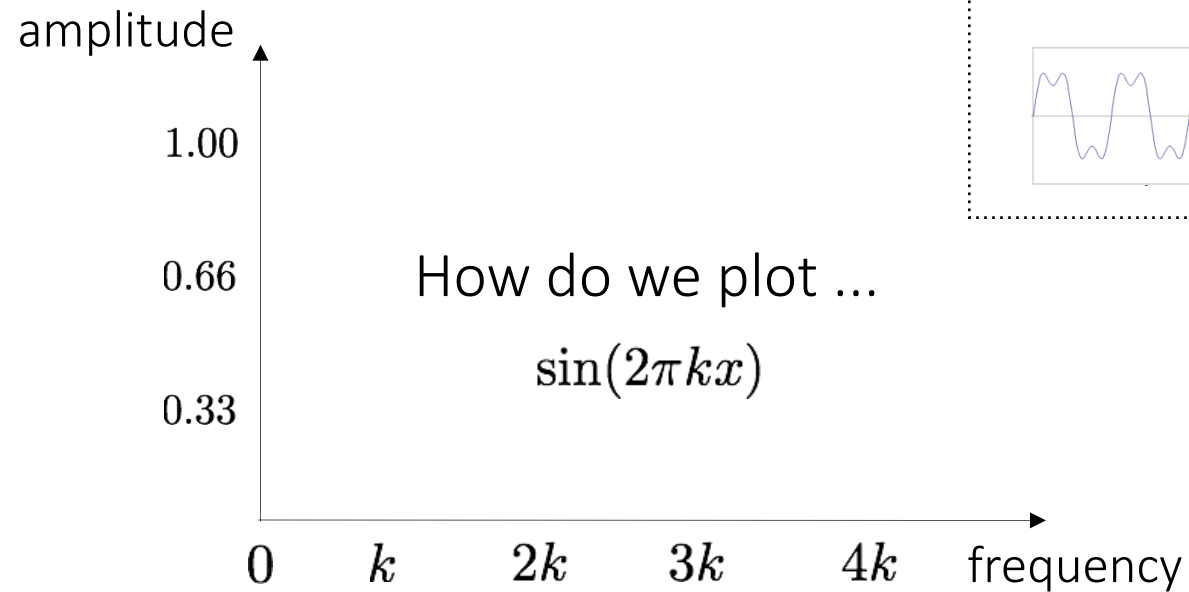

Visualizing the frequency spectrum

Recall the temporal domain visualization

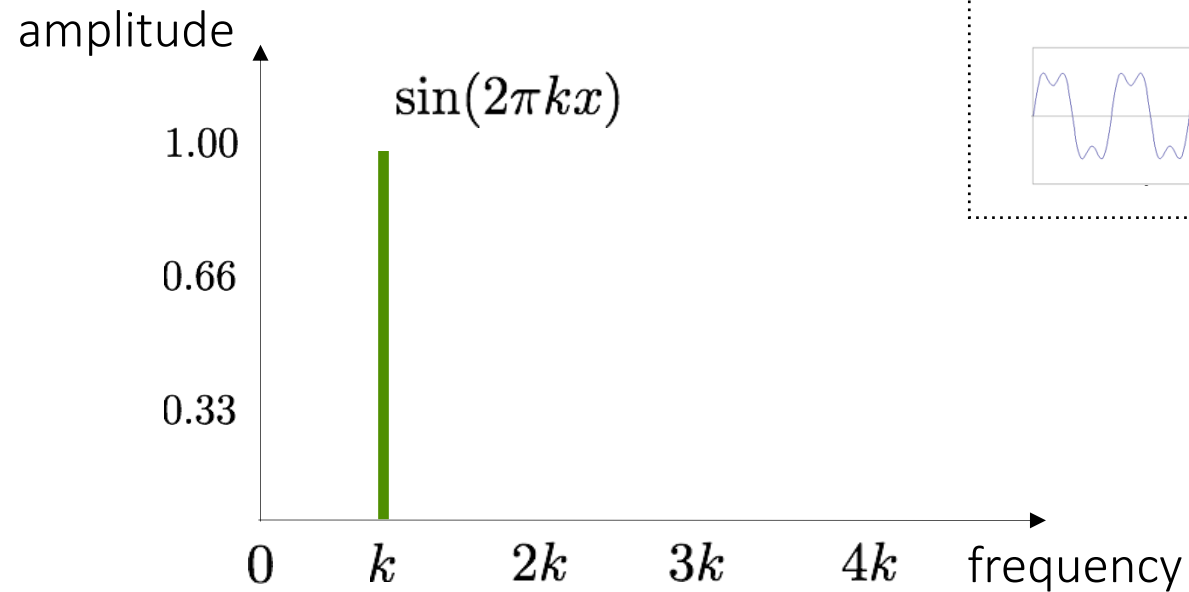

$$f(x) = \sin(2\pi kx) + \frac{1}{3} \sin(2\pi 3kx)$$

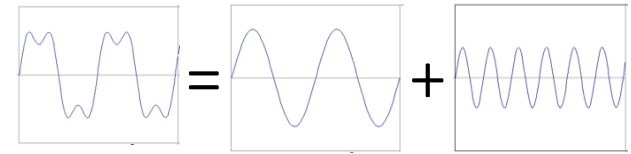

Visualizing the frequency spectrum

Recall the temporal domain visualization

$$f(x) = \sin(2\pi kx) + \frac{1}{3} \sin(2\pi 3kx)$$

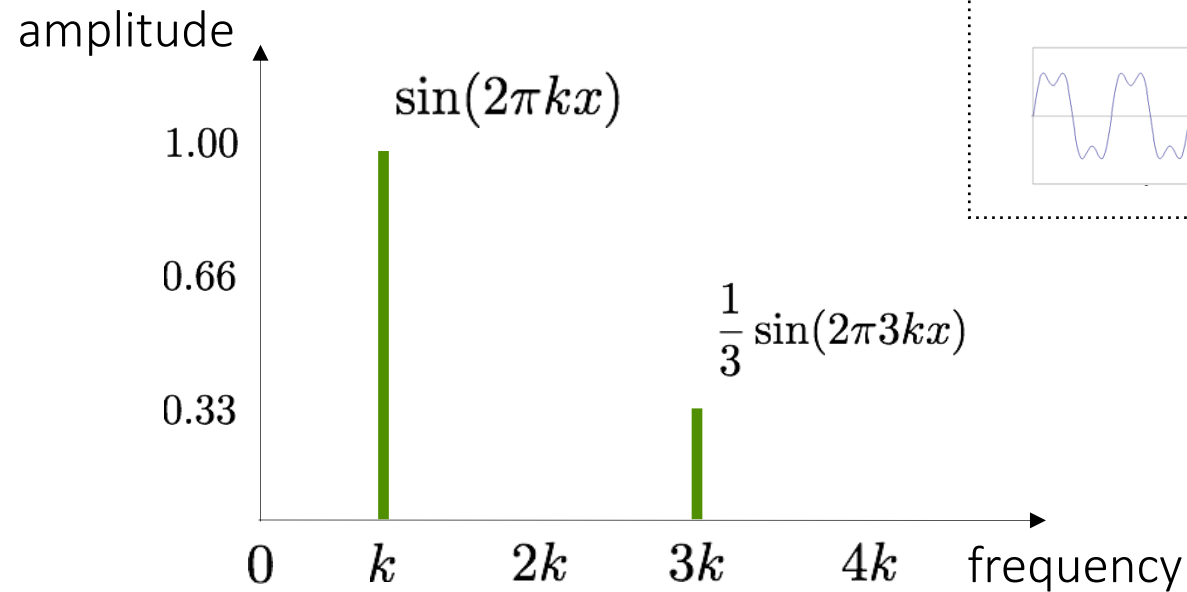
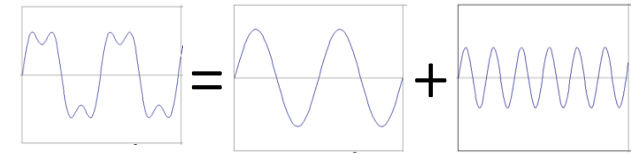

Visualizing the frequency spectrum

Recall the temporal domain visualization

$$f(x) = \sin(2\pi kx) + \frac{1}{3} \sin(2\pi 3kx)$$

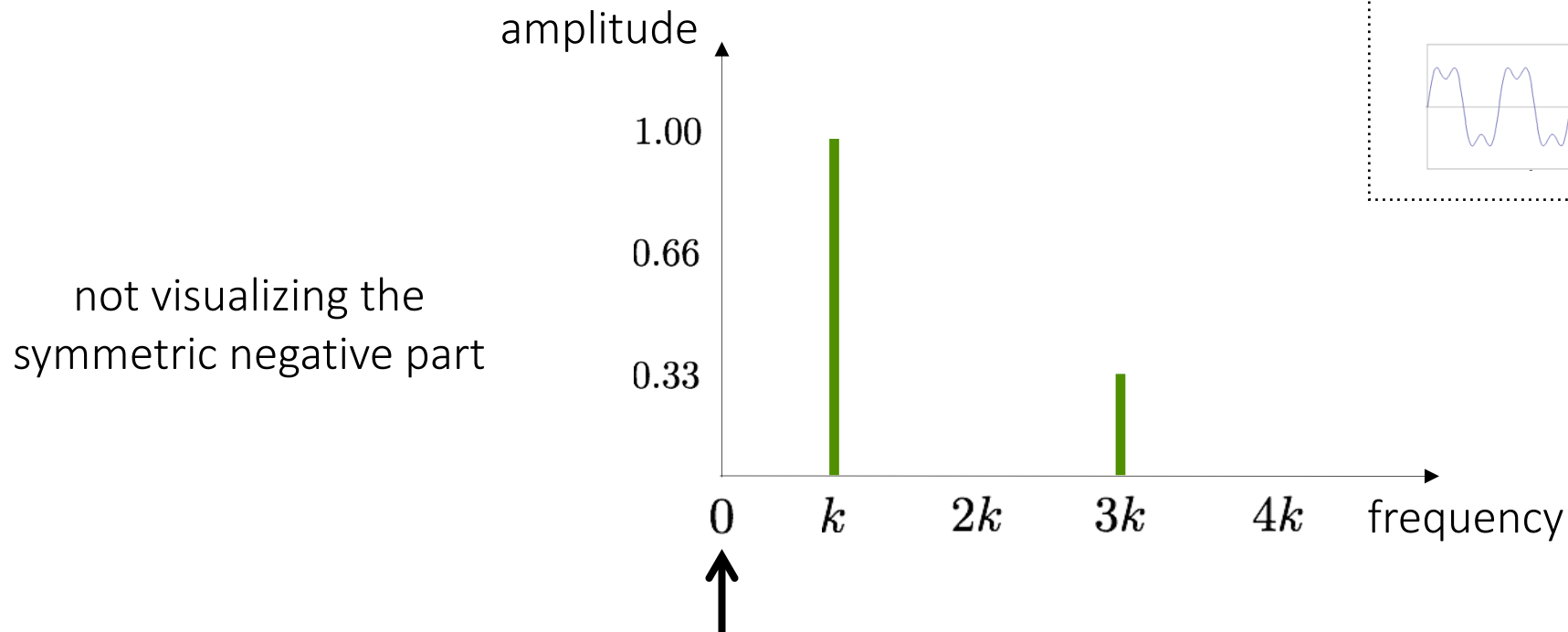

not visualizing the symmetric negative part

What is at zero frequency?

Need to understand this to understand the 2D version!

Visualizing the frequency spectrum

Recall the temporal domain visualization

$$f(x) = \sin(2\pi kx) + \frac{1}{3} \sin(2\pi 3kx)$$

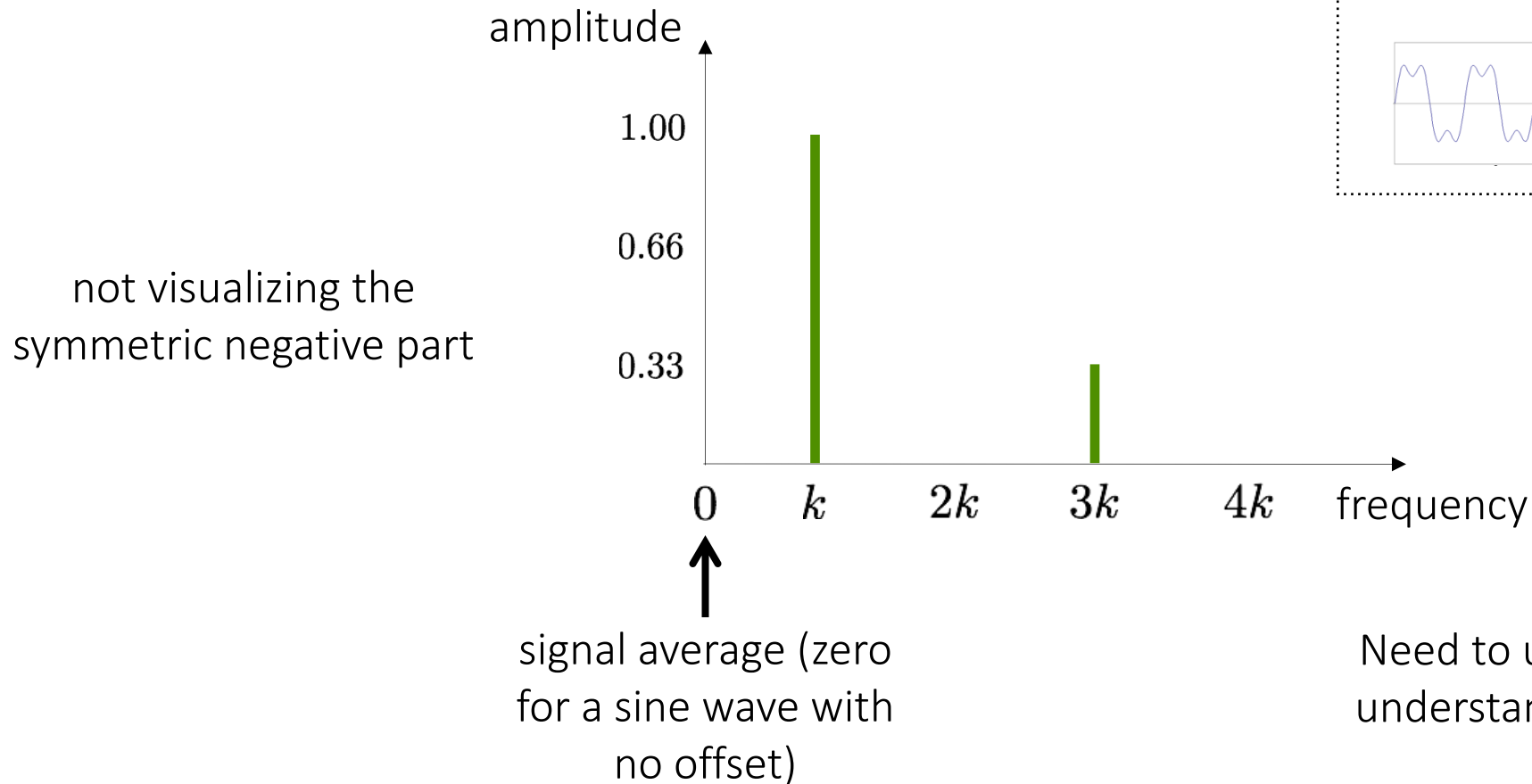

Need to understand this to understand the 2D version!

Examples

Spatial domain visualization

Frequency domain visualization

1D

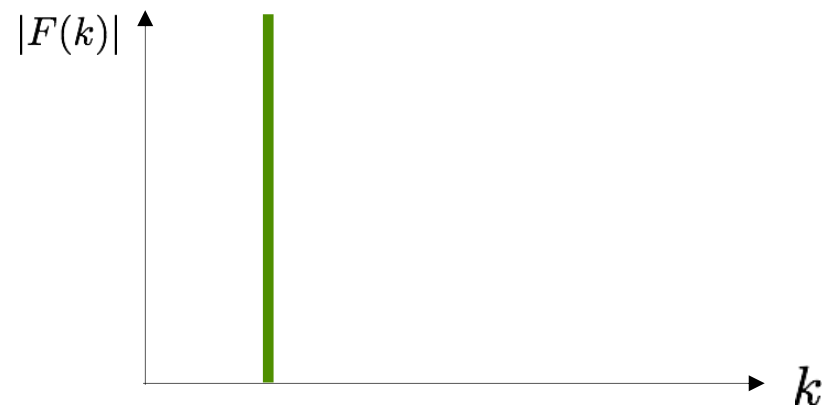
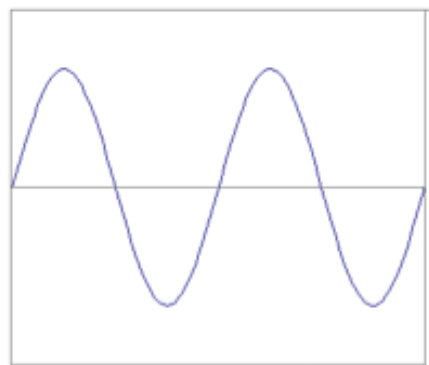

2D



?

Examples

Spatial domain visualization

Frequency domain visualization

1D

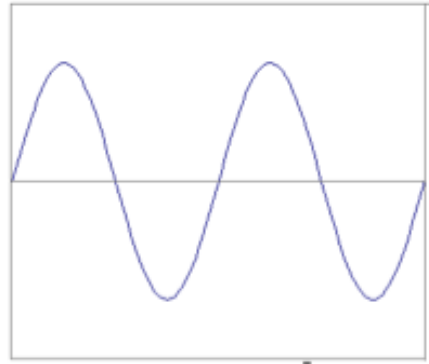

2D

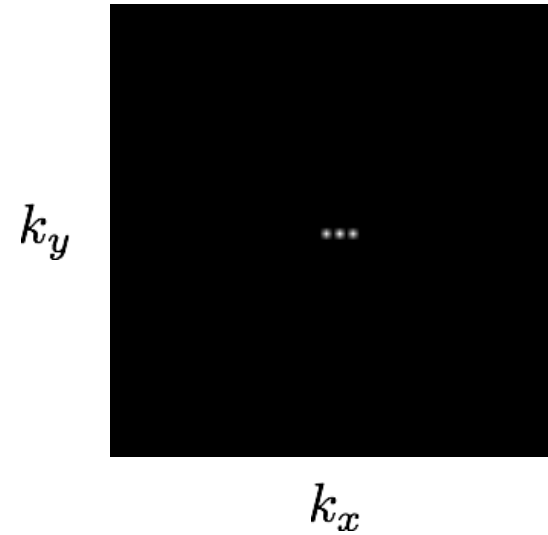

What do the three dots correspond to?

Examples

Spatial domain visualization



Frequency domain visualization

?

k_y

k_x

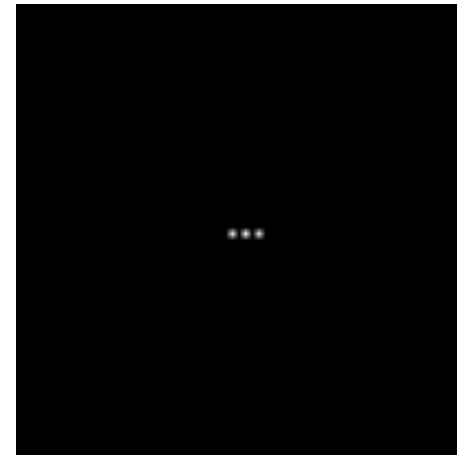

Examples

Spatial domain visualization

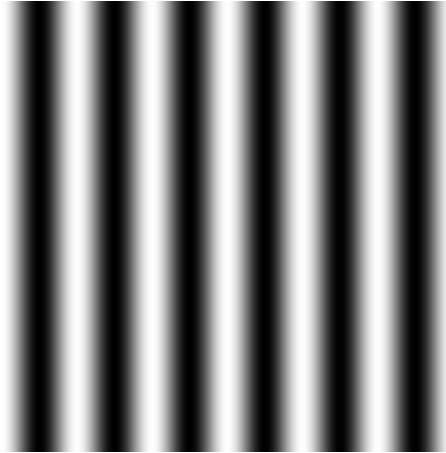

Frequency domain visualization

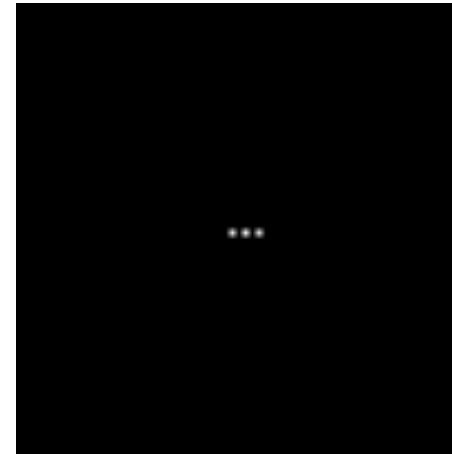
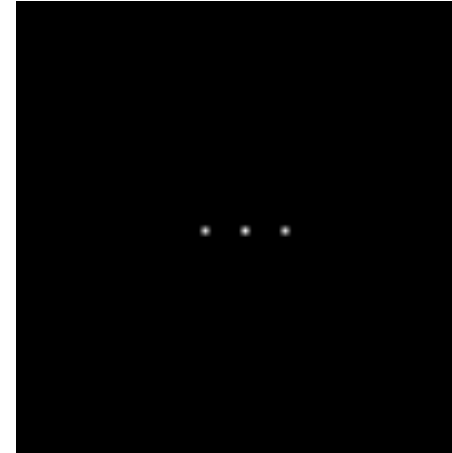

k_y

k_x

Examples

How would you generate this image with sine waves?

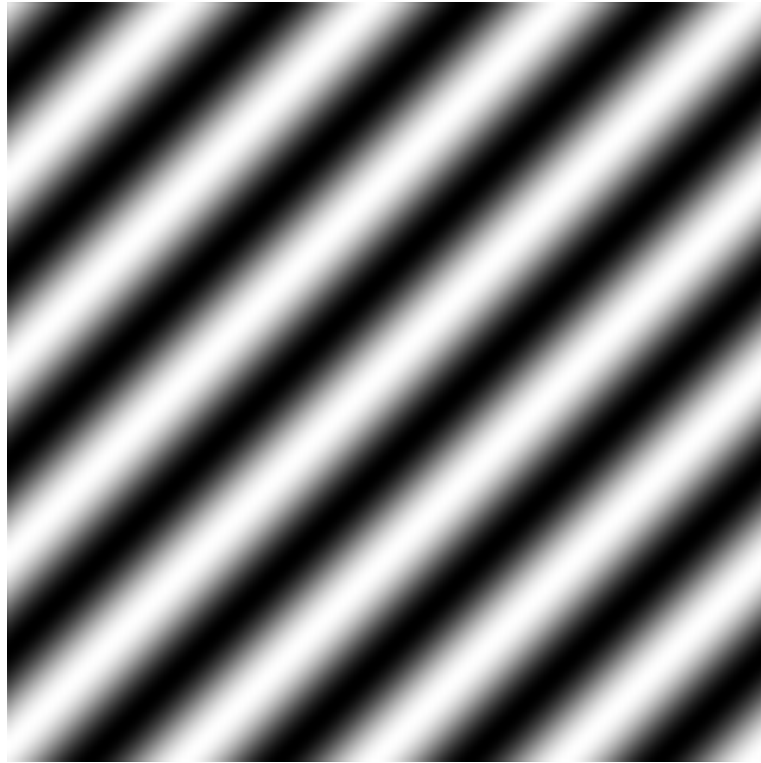

Examples

How would you generate this image with sine waves?

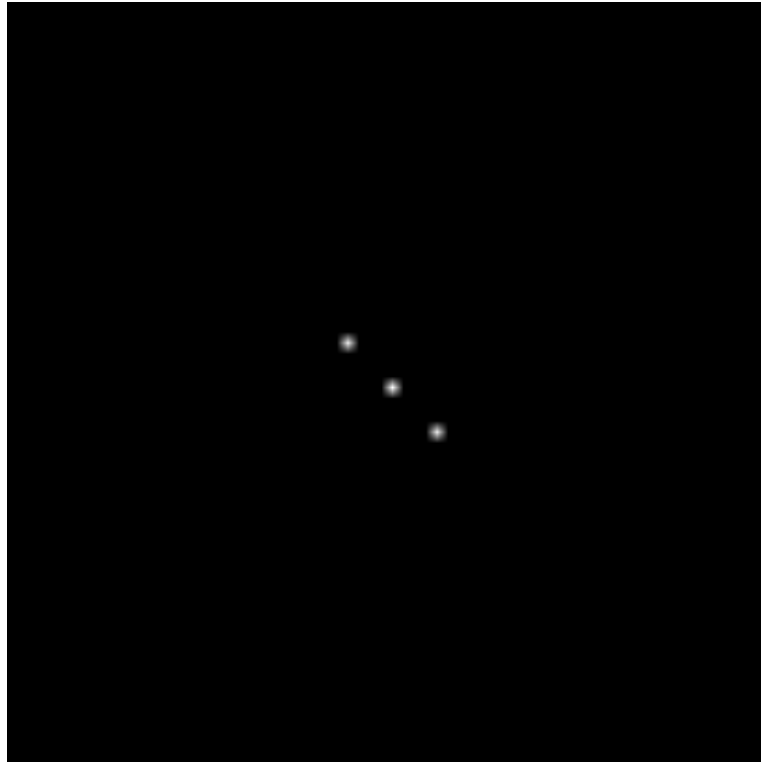

Has both an x and
y components

Examples



+

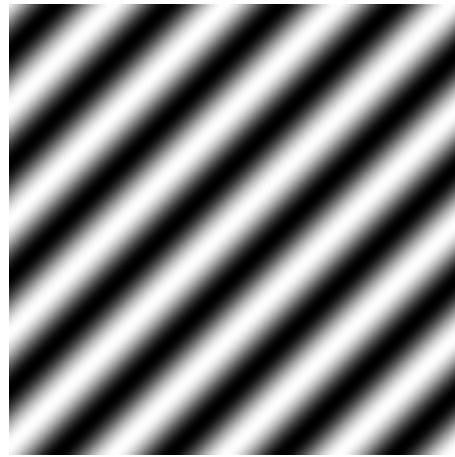

=

?

Examples

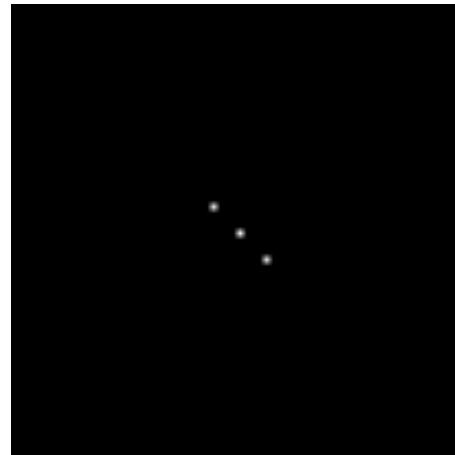
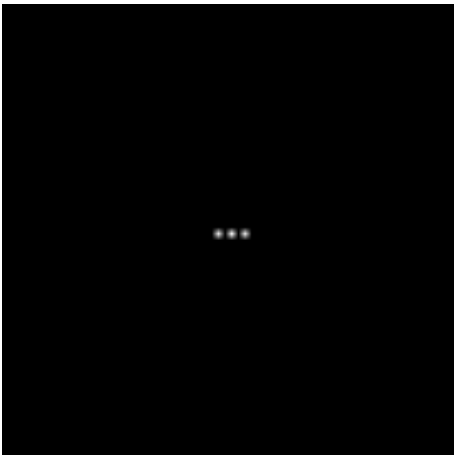
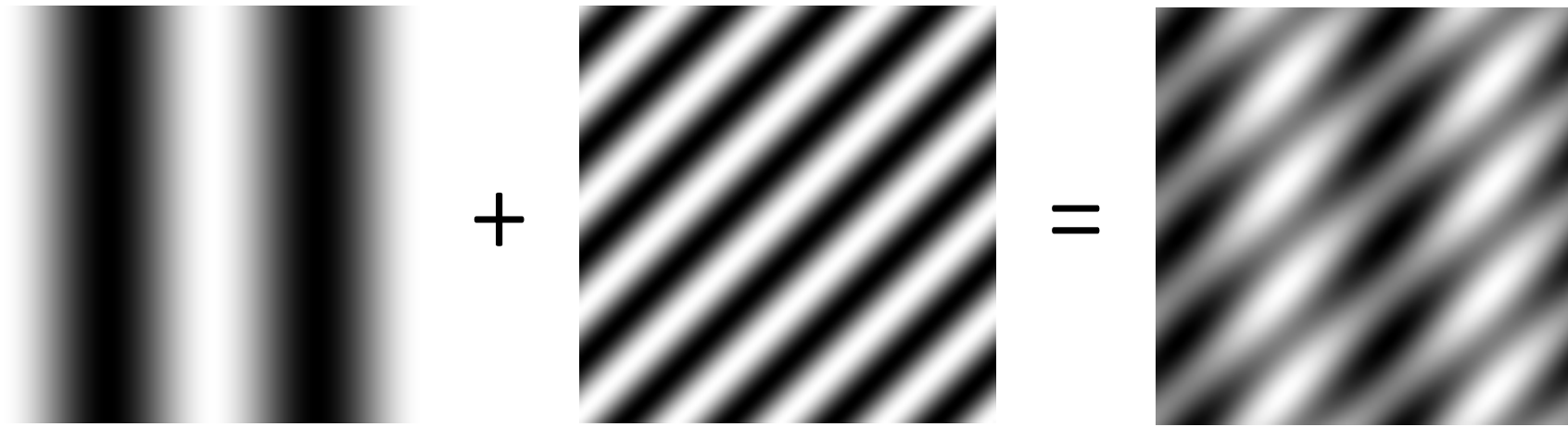

?

Examples

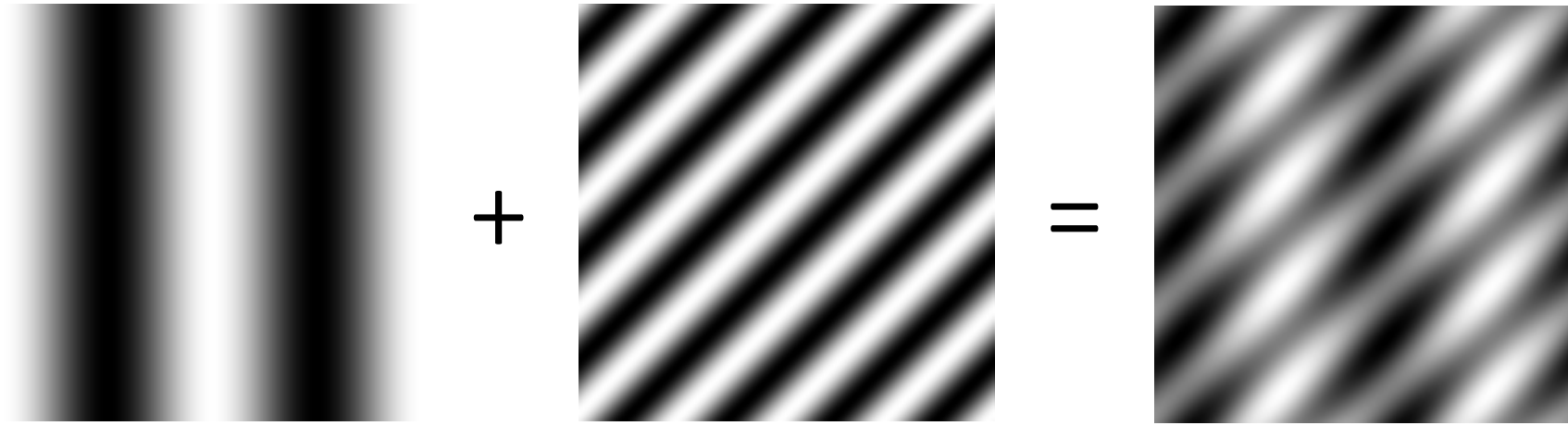

Basic building block

$$A \sin(\omega x + \phi)$$

The diagram shows the equation $A \sin(\omega x + \phi)$ with five arrows pointing to its components: 'amplitude' points to A , 'sinusoid' points to \sin , 'angular frequency' points to ω , 'variable' points to x , and 'phase' points to ϕ .

What about non-periodic signals?

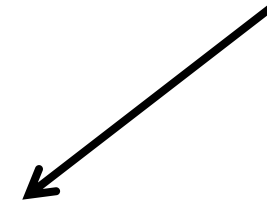

Fourier's claim: Add enough of these to get any *periodic* signal you want!

Fourier transform

Recalling some basics

Complex numbers have two parts:

rectangular
coordinates

$$R + jI$$

what's this? what's this?

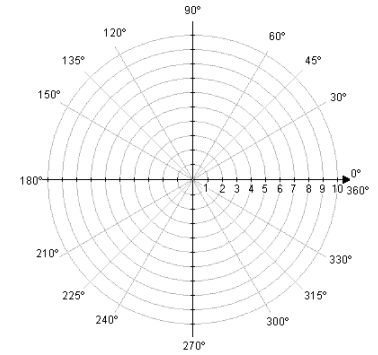
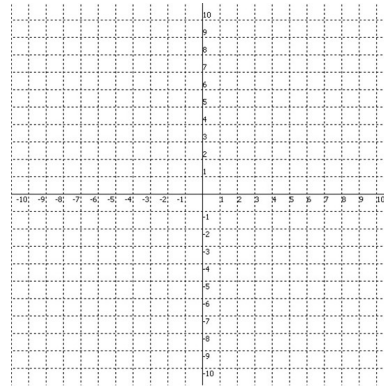

Recalling some basics

Complex numbers have two parts:

rectangular
coordinates

$$R + jI$$

real imaginary

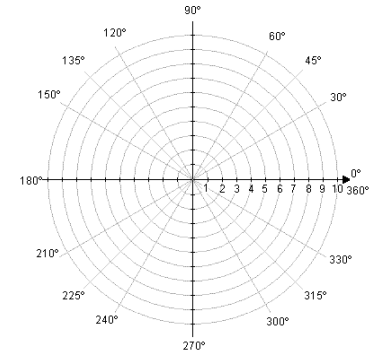
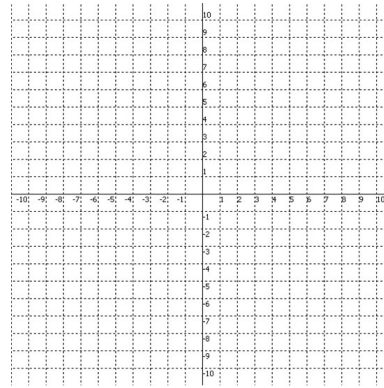

Recalling some basics

Complex numbers have two parts:

rectangular
coordinates

$$R + jI$$

real imaginary

Alternative reparameterization:

polar
coordinates

$$r(\cos \theta + j \sin \theta)$$

how do we compute these?

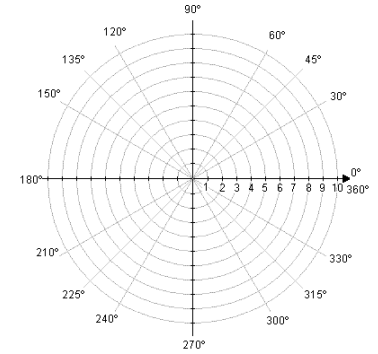
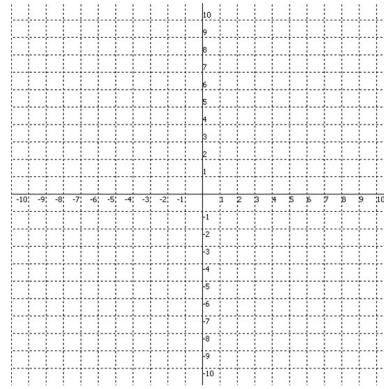

polar transform

Recalling some basics

Complex numbers have two parts:

rectangular
coordinates

$$R + jI$$

real imaginary

Alternative reparameterization:

polar
coordinates

$$r(\cos \theta + j \sin \theta)$$

polar transform

$$\theta = \tan^{-1}\left(\frac{I}{R}\right) \quad r = \sqrt{R^2 + I^2}$$

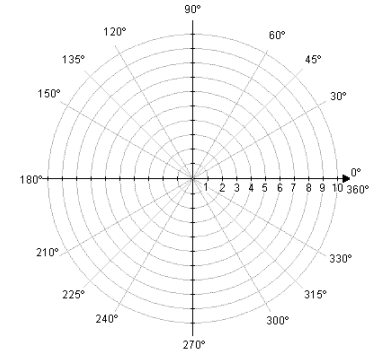
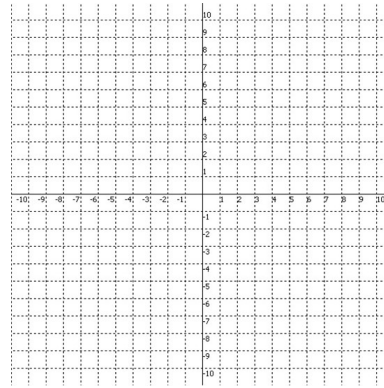

polar transform

Recalling some basics

Complex numbers have two parts:

rectangular
coordinates

$$R + jI$$

real imaginary

Alternative reparameterization:

polar
coordinates

$$r(\cos \theta + j \sin \theta)$$

polar transform

$$\theta = \tan^{-1}\left(\frac{I}{R}\right) \quad r = \sqrt{R^2 + I^2}$$

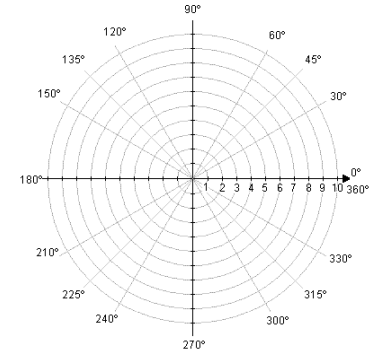
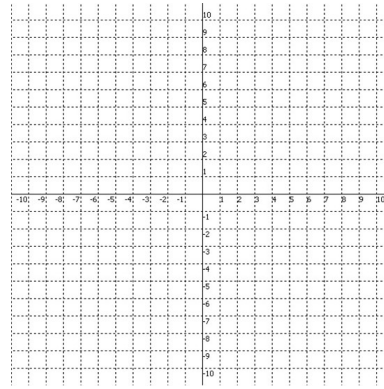

polar transform

How do you write
these in exponential
form?

Recalling some basics

Complex numbers have two parts:

rectangular
coordinates

$$R + jI$$

real imaginary

Alternative reparameterization:

polar
coordinates

$$r(\cos \theta + j \sin \theta)$$

polar transform

$$\theta = \tan^{-1}\left(\frac{I}{R}\right) \quad r = \sqrt{R^2 + I^2}$$

or
equivalently

$$re^{j\theta}$$

how did we get this?

exponential
form

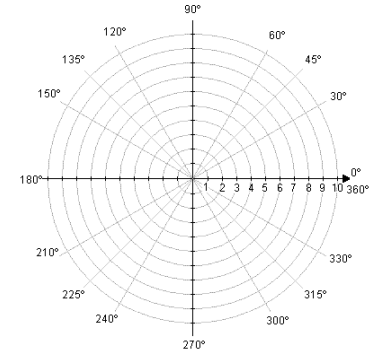
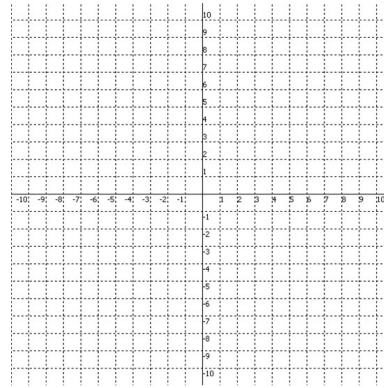

Recalling some basics

Complex numbers have two parts:

rectangular
coordinates

$$R + jI$$

real imaginary

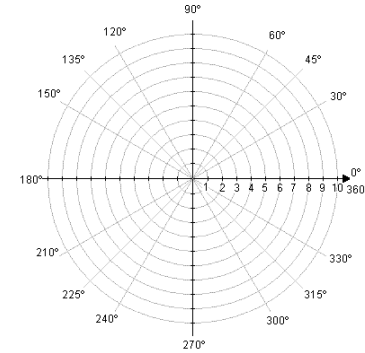
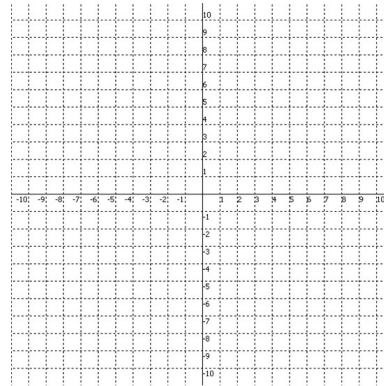

Alternative reparameterization:

polar
coordinates

$$r(\cos \theta + j \sin \theta)$$

polar transform

$$\theta = \tan^{-1}\left(\frac{I}{R}\right) \quad r = \sqrt{R^2 + I^2}$$

or
equivalently

$$re^{j\theta}$$

Euler's formula

$$e^{j\theta} = \cos \theta + j \sin \theta$$

exponential
form

This will help us understand the Fourier transform equations

Fourier transform

Fourier transform

inverse Fourier transform

continuous

$$F(k) = \int_{-\infty}^{\infty} f(x) e^{-j2\pi kx} dx$$

$$f(x) = \int_{-\infty}^{\infty} F(k) e^{j2\pi kx} dk$$

discrete

$$F(k) = \frac{1}{N} \sum_{x=0}^{N-1} f(x) e^{-j2\pi kx/N}$$

$k = 0, 1, 2, \dots, N-1$

$$f(x) = \sum_{k=0}^{N-1} F(k) e^{j2\pi kx/N}$$

$x = 0, 1, 2, \dots, N-1$

Where is the connection to the 'summation of sine waves' idea?

Fourier transform

Fourier transform

inverse Fourier transform

continuous

$$F(k) = \int_{-\infty}^{\infty} f(x) e^{-j2\pi kx} dx$$

$$f(x) = \int_{-\infty}^{\infty} F(k) e^{j2\pi kx} dk$$

discrete

$$F(k) = \frac{1}{N} \sum_{x=0}^{N-1} f(x) e^{-j2\pi kx/N}$$

$k = 0, 1, 2, \dots, N-1$

$$f(x) = \sum_{k=0}^{N-1} F(k) e^{j2\pi kx/N}$$

$x = 0, 1, 2, \dots, N-1$

Where is the connection to the 'summation of sine waves' idea?

Fourier transform

Where is the connection to the 'summation of sine waves' idea?

$$f(x) = \sum_{k=0}^{N-1} F(k) e^{j2\pi kx/N}$$

Euler's formula
 $e^{j\theta} = \cos \theta + j \sin \theta$

sum over frequencies

$$f(x) = \sum_{k=0}^{N-1} F(k) \left\{ \cos(2\pi kx) + j \sin(2\pi kx) \right\}$$

scaling parameter

wave components

Fourier transform pairs

spatial domain

frequency domain

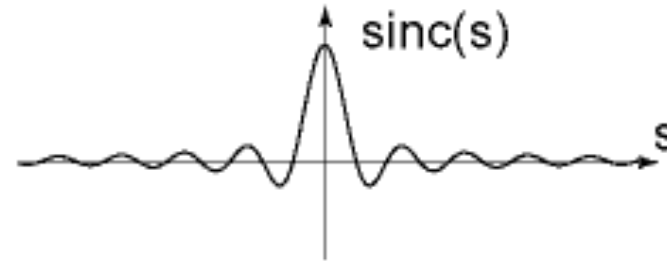
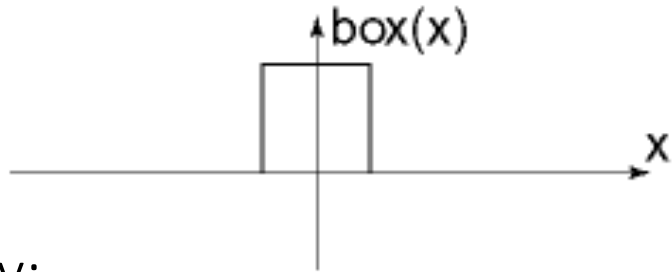

Note the symmetry:
duality property of
Fourier transform

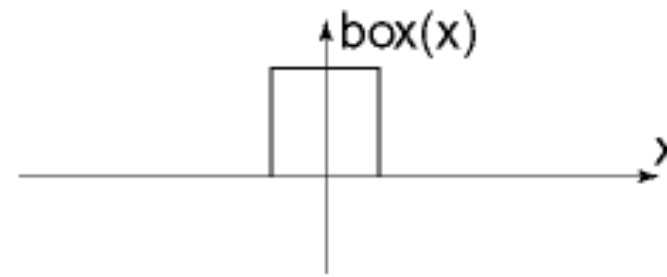
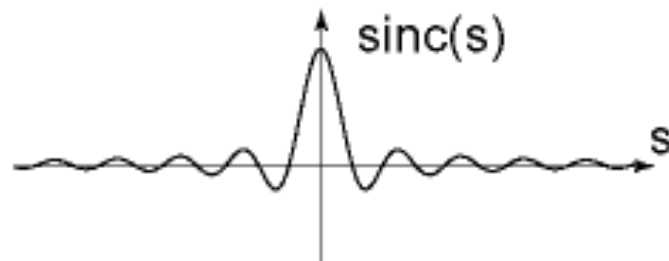
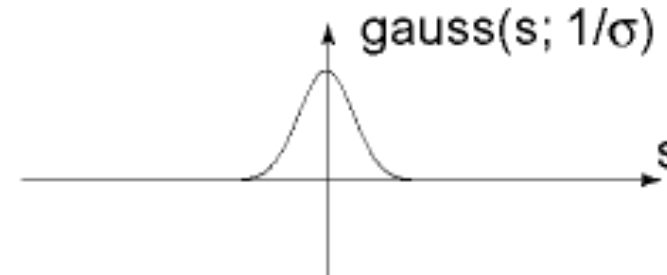
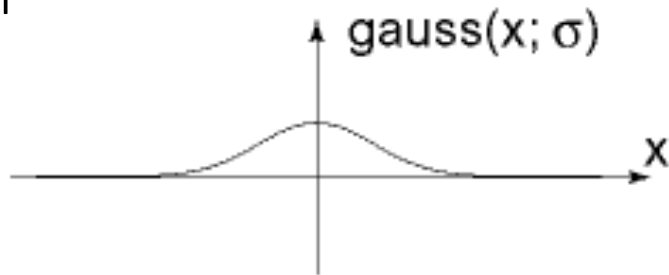

Computing the discrete Fourier transform (DFT)

Computing the discrete Fourier transform (DFT)

$$F(k) = \frac{1}{N} \sum_{x=0}^{N-1} f(x) e^{-j2\pi kx/N} \text{ is just a matrix multiplication:}$$

$$\mathbf{F} = \mathbf{W} \mathbf{f}$$

$$\begin{bmatrix} F(0) \\ F(1) \\ F(2) \\ F(3) \\ \vdots \\ F(N-1) \end{bmatrix} = \begin{bmatrix} W^0 & W^0 & W^0 & W^0 & \dots & W^0 \\ W^0 & W^1 & W^2 & W^3 & \dots & W^{N-1} \\ W^0 & W^2 & W^4 & W^6 & \dots & W^{N-2} \\ W^0 & W^3 & W^6 & W^9 & \dots & W^{N-3} \\ \vdots & \vdots & \vdots & \vdots & \ddots & \vdots \\ W^0 & W^{N-1} & W^{N-2} & W^{N-3} & \dots & W^1 \end{bmatrix} \begin{bmatrix} f(0) \\ f(1) \\ f(2) \\ f(3) \\ \vdots \\ f(N-1) \end{bmatrix} \quad W = e^{-j2\pi/N}$$

In practice this is implemented using the *fast Fourier transform* (FFT) algorithm.

Fourier transforms of natural images

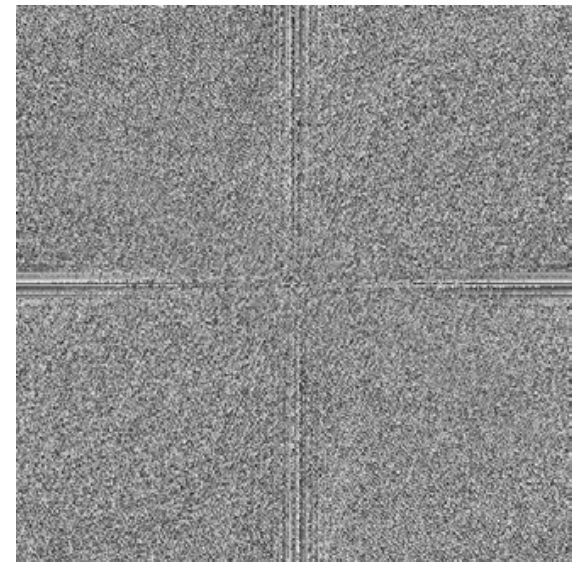
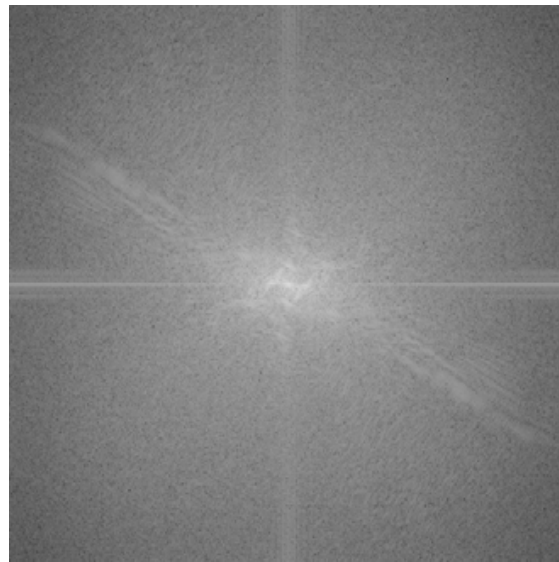
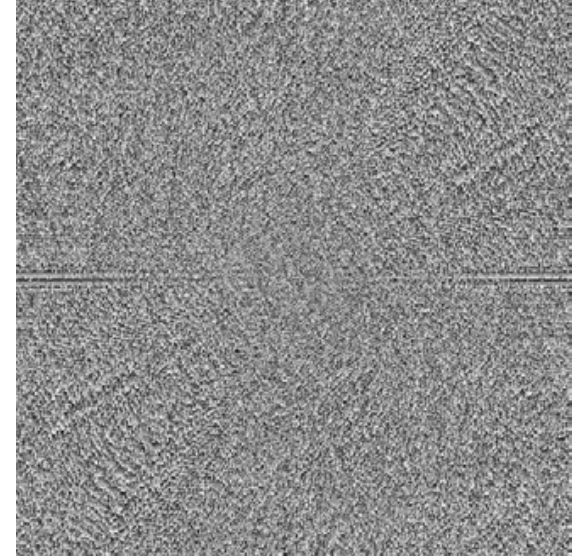
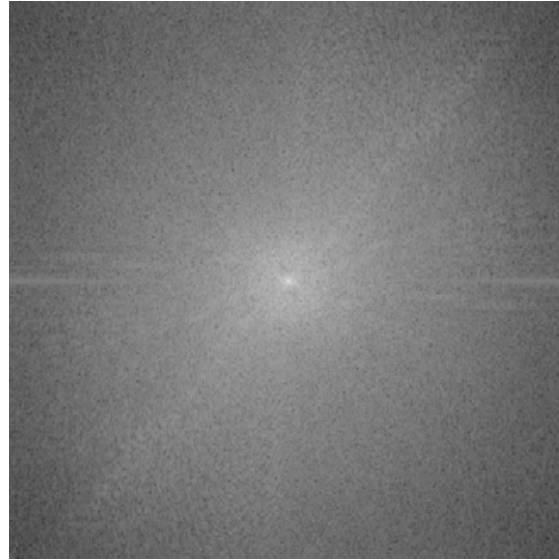

original

amplitude

phase

Fourier transforms of natural images

Image phase matters!



cheetah phase with zebra amplitude



zebra phase with cheetah amplitude

Frequency-domain filtering

Why do we care about all this?

The convolution theorem

The Fourier transform of the convolution of two functions is the product of their Fourier transforms:

$$\mathcal{F}\{g * h\} = \mathcal{F}\{g\}\mathcal{F}\{h\}$$

The inverse Fourier transform of the product of two Fourier transforms is the convolution of the two inverse Fourier transforms:

$$\mathcal{F}^{-1}\{gh\} = \mathcal{F}^{-1}\{g\} * \mathcal{F}^{-1}\{h\}$$

Convolution in spatial domain is equivalent to multiplication in frequency domain!

What do we use convolution for?

Convolution for 1D continuous signals

Definition of linear shift-invariant filtering as convolution:

$$(f * g)(x) = \int_{-\infty}^{\infty} f(y)g(x - y)dy$$

filtered signal \nearrow \nwarrow filter \nwarrow input signal

Using the convolution theorem, we can interpret and implement all types of linear shift-invariant filtering as multiplication in frequency domain.

Why implement convolution in frequency domain?

Spatial domain filtering

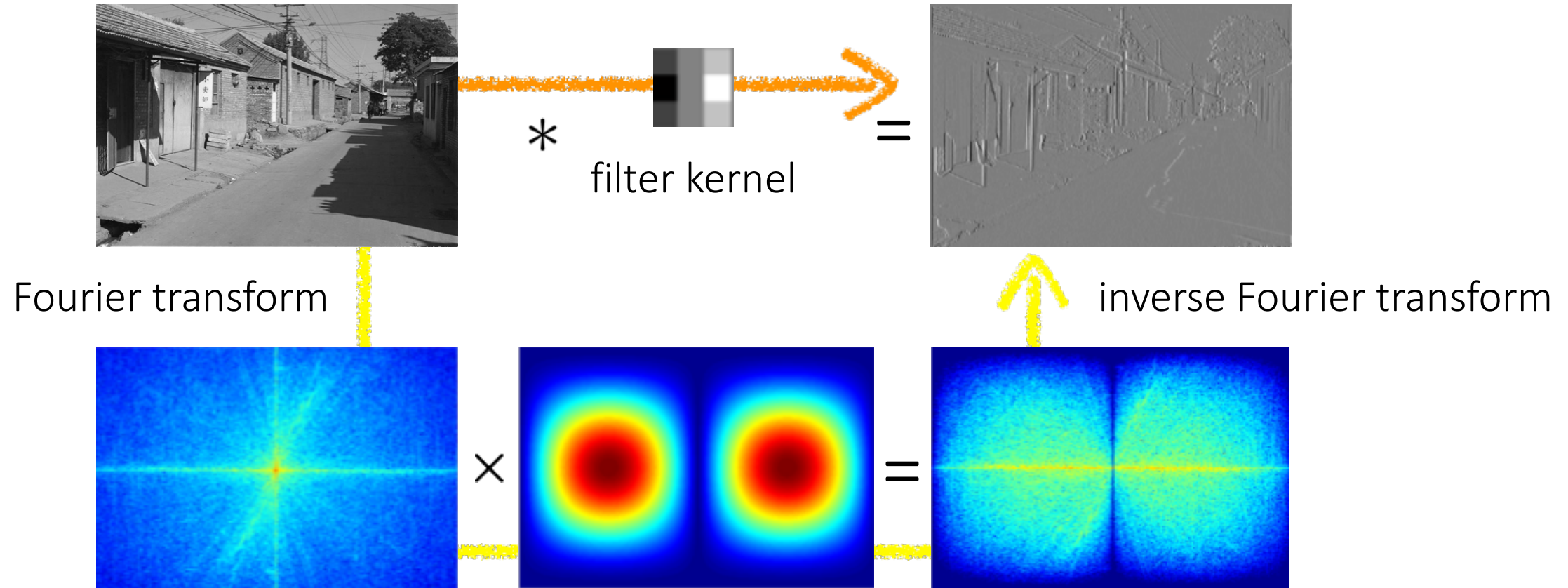

Frequency domain filtering

Revisiting blurring

Why does the Gaussian give a nice smooth image, but the square filter give edgy artifacts?

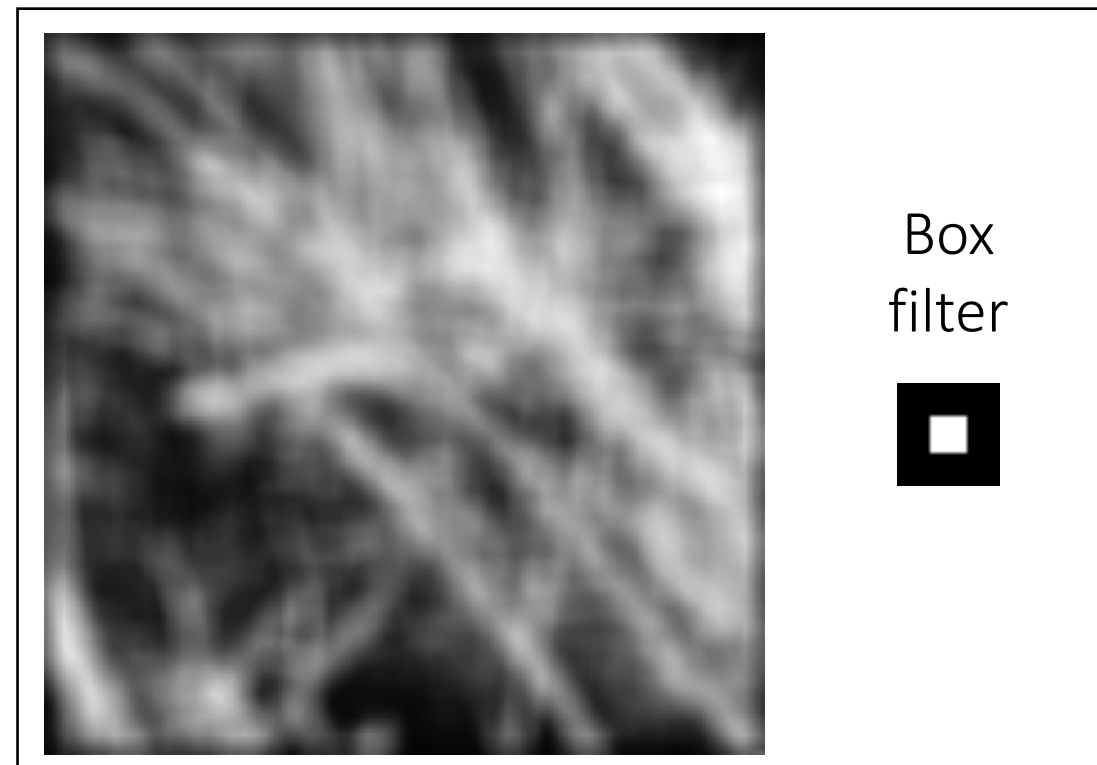
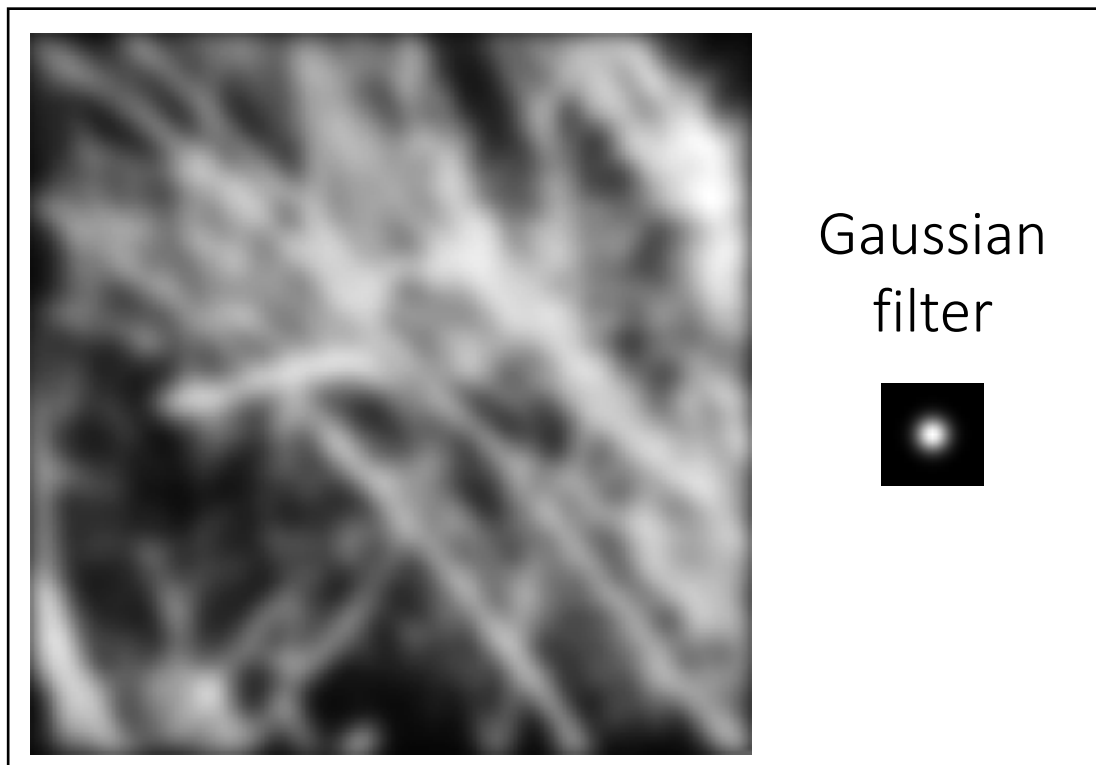

Gaussian blur

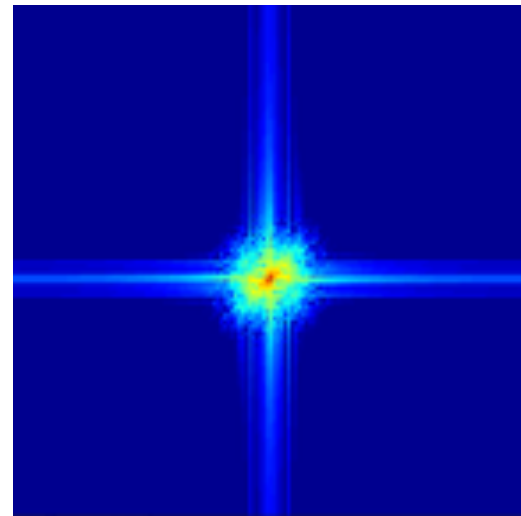
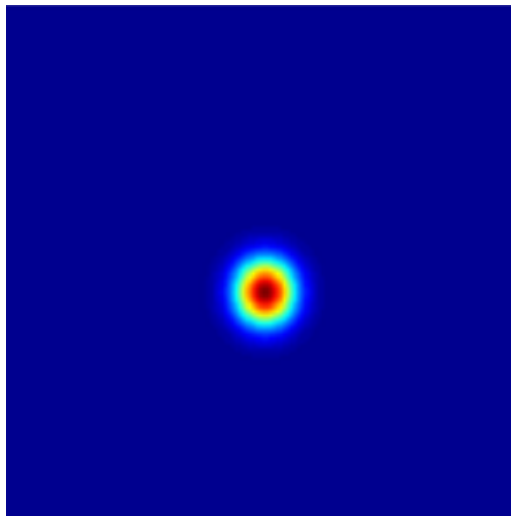
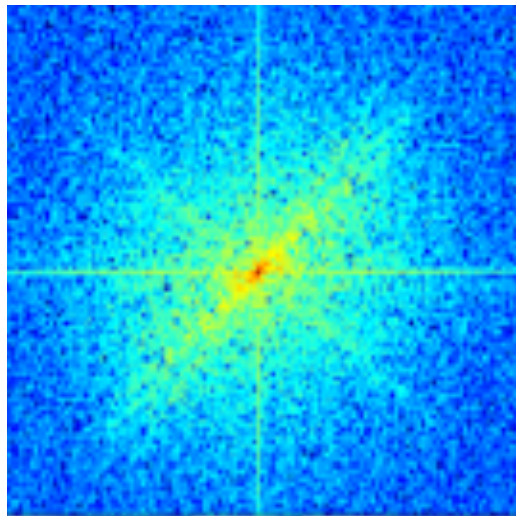
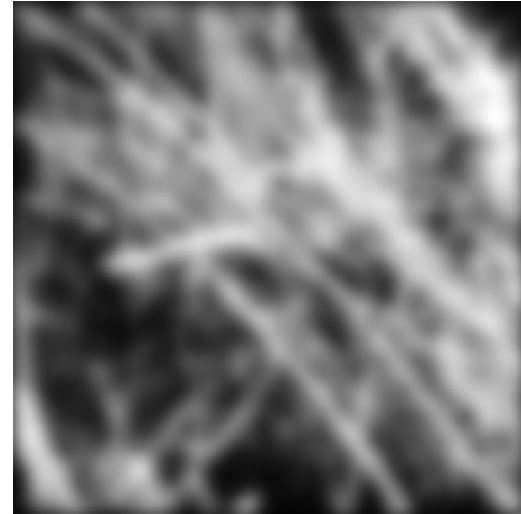
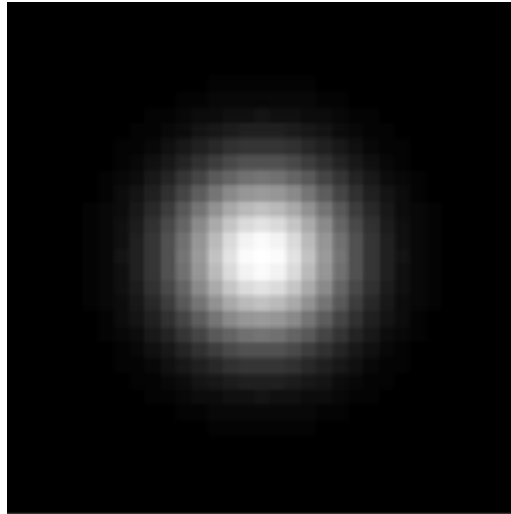

Box blur

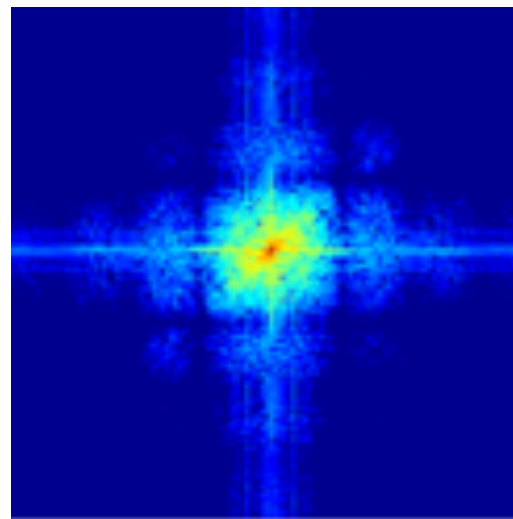
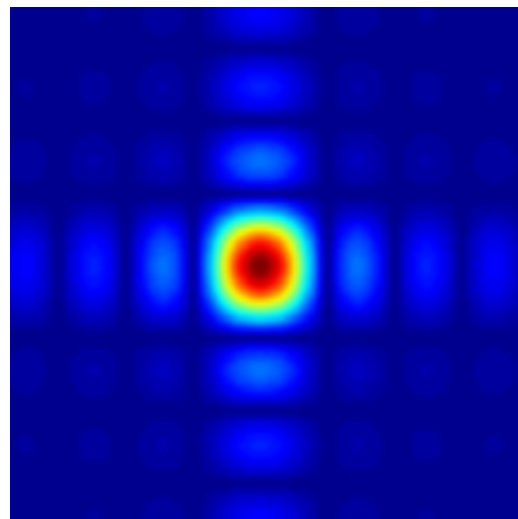
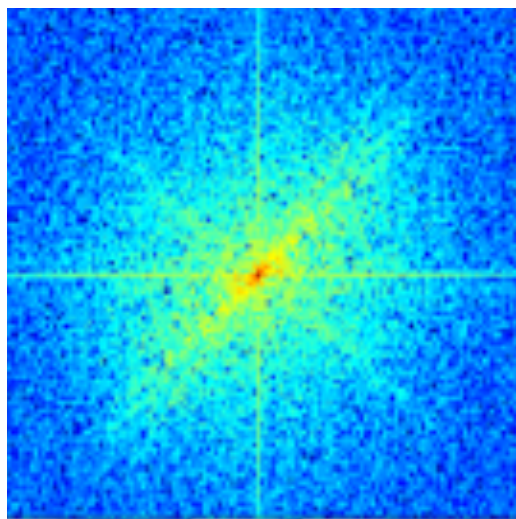
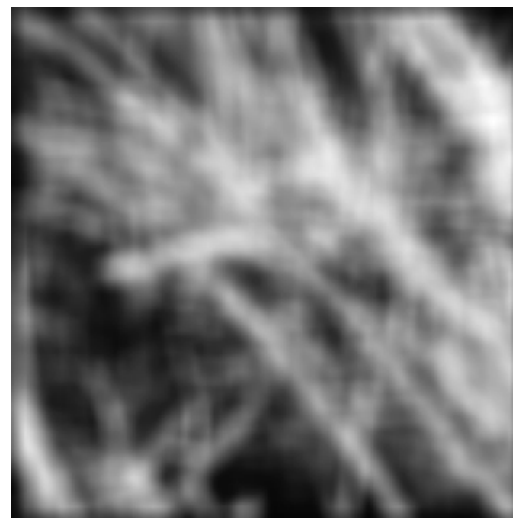

More filtering examples

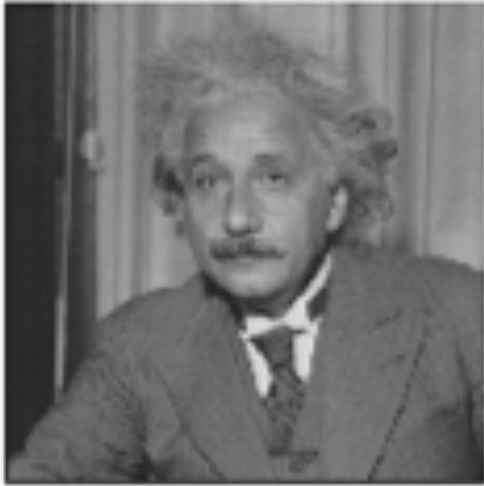

?

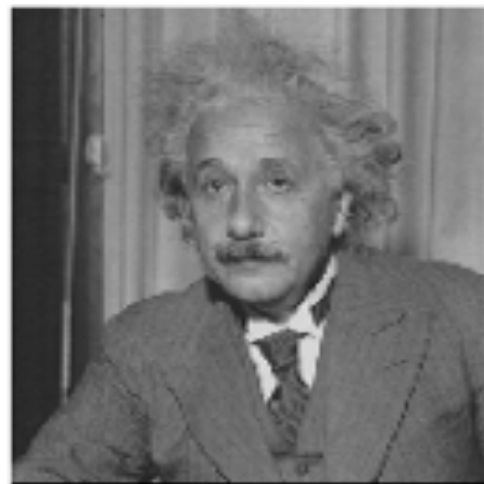
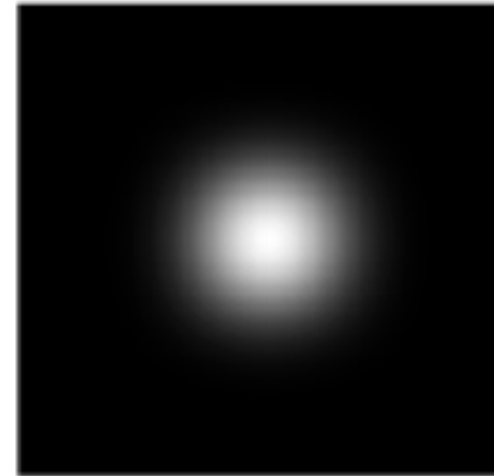

?



filters shown
in frequency-
domain

More filtering examples

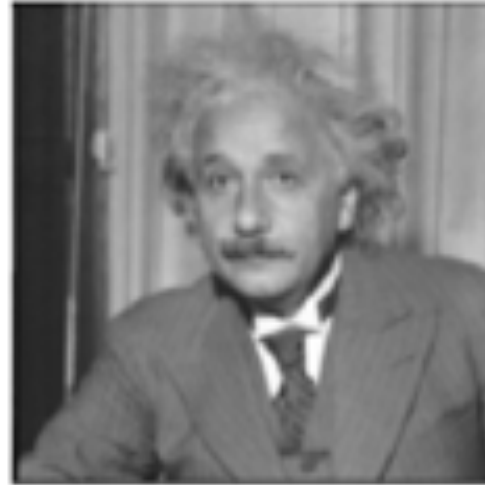
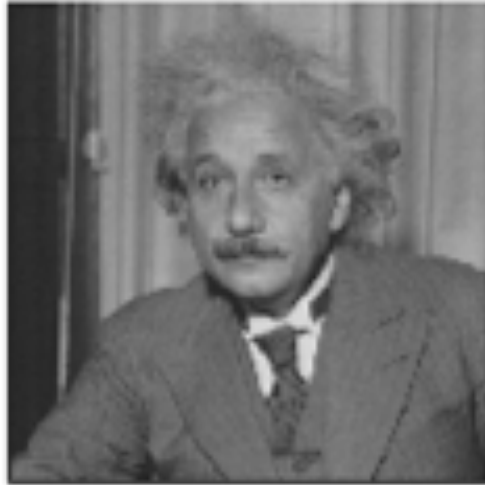

low-pass

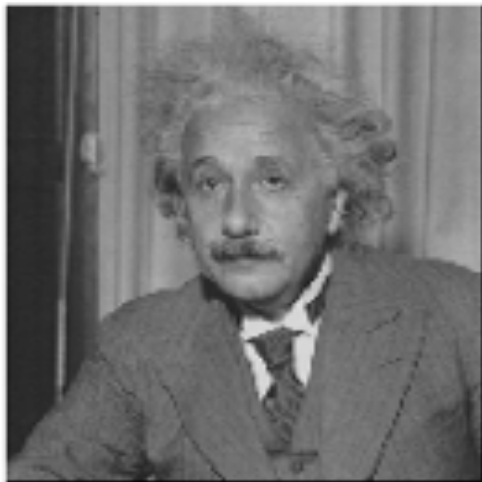
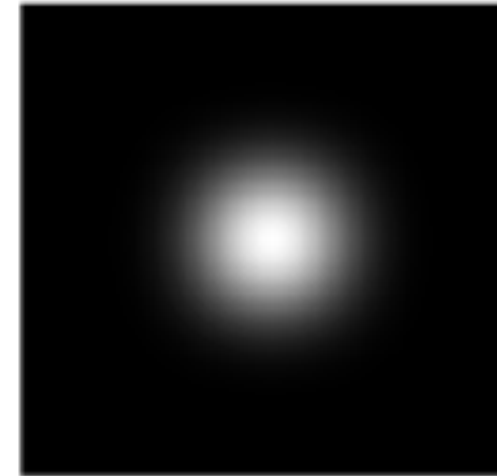

band-pass

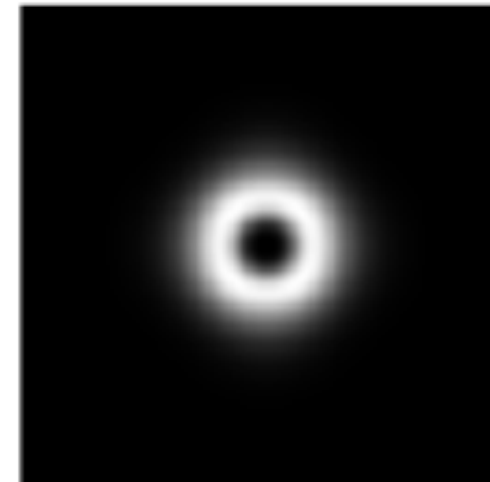

filters shown
in frequency-
domain

More filtering examples



?

high-pass

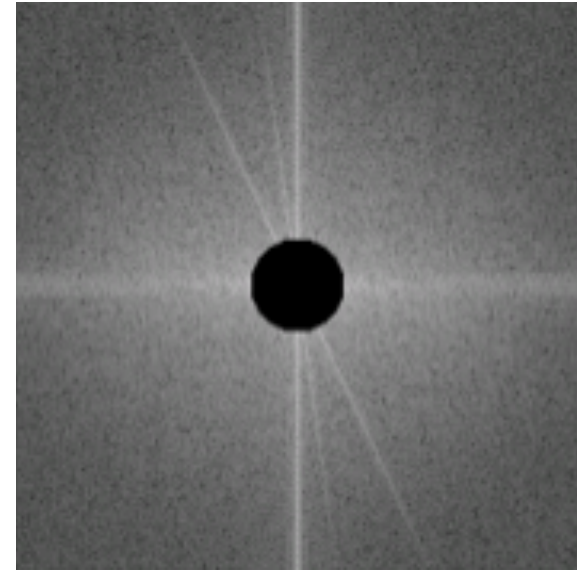

More filtering examples

high-pass

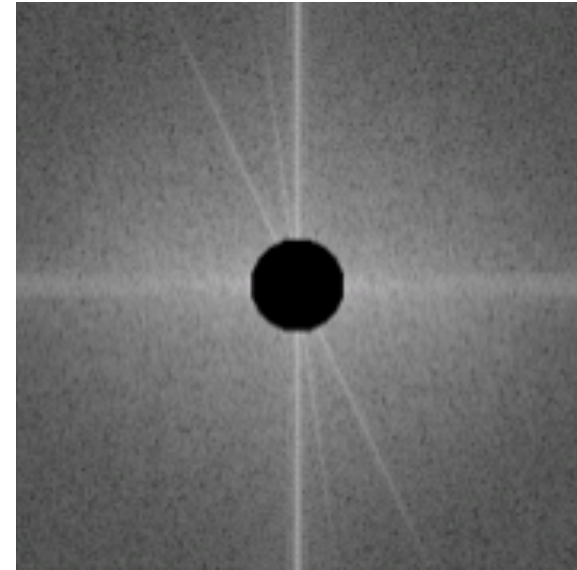

More filtering examples

original image

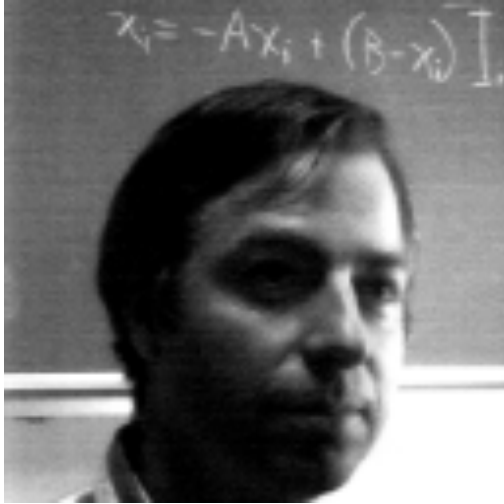

low-pass filter

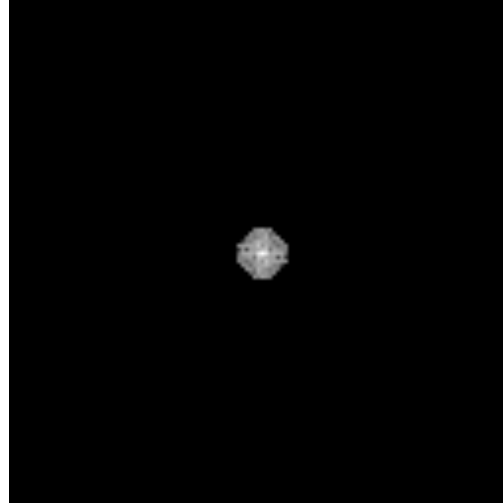

?

frequency magnitude

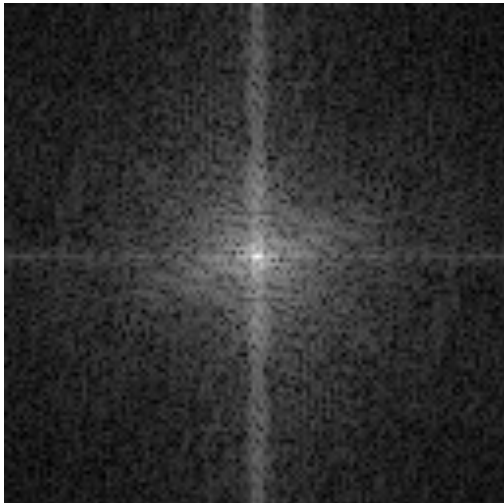

More filtering examples

original image

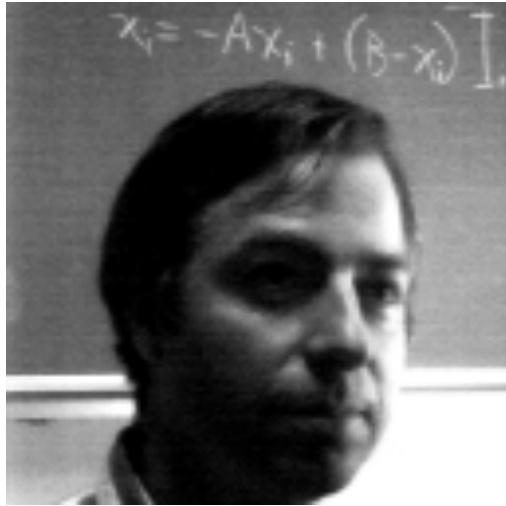

low-pass filter

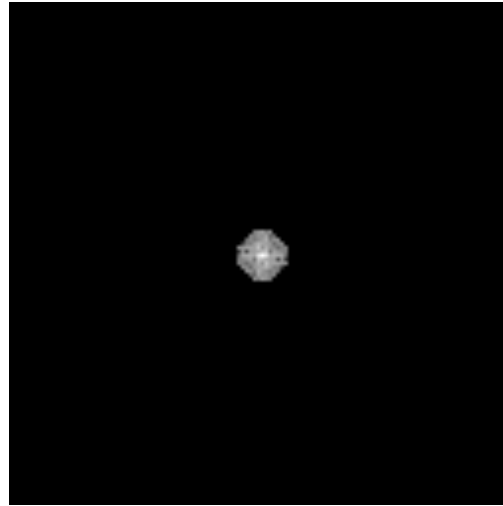

frequency magnitude

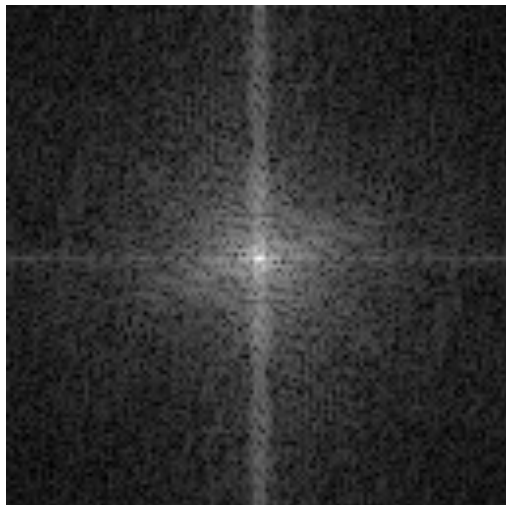

More filtering examples

original image

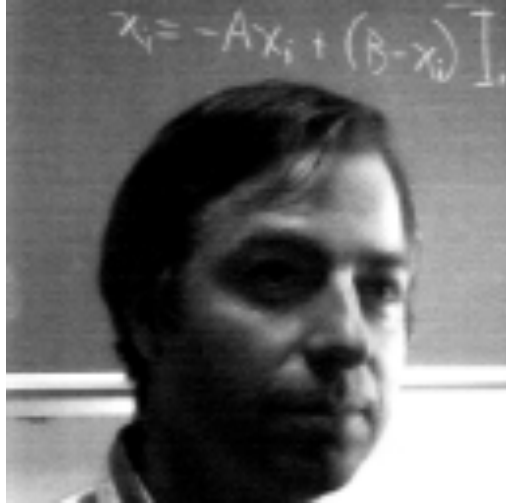

high-pass filter

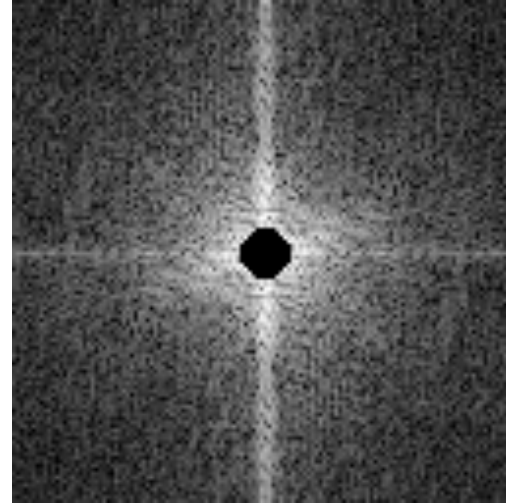

?

frequency magnitude

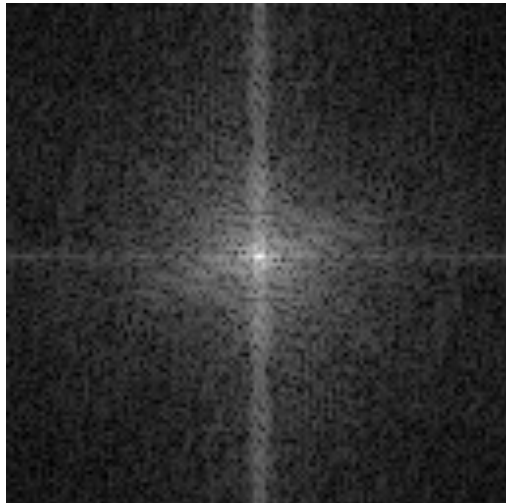

More filtering examples

original image

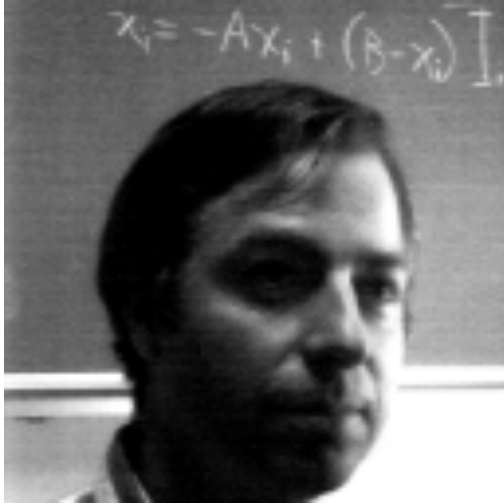

high-pass filter

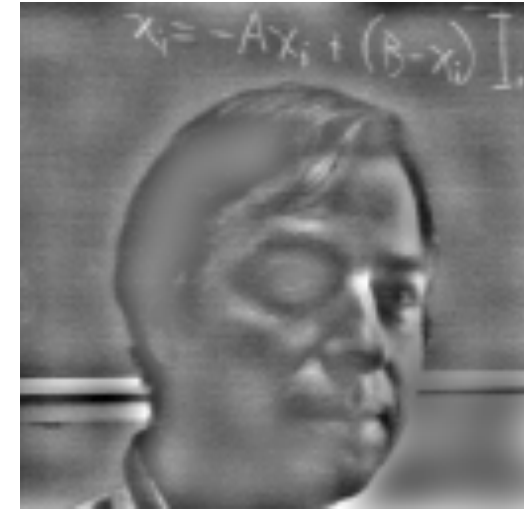
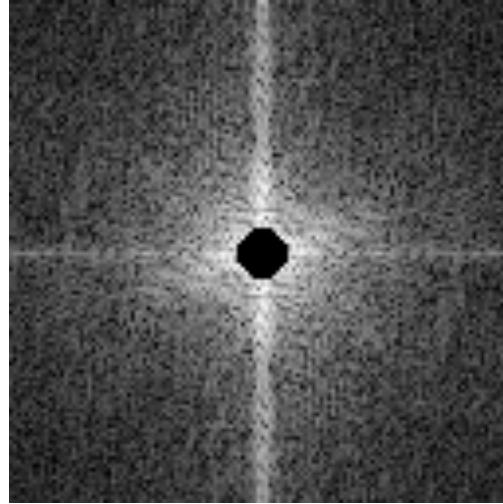

frequency magnitude

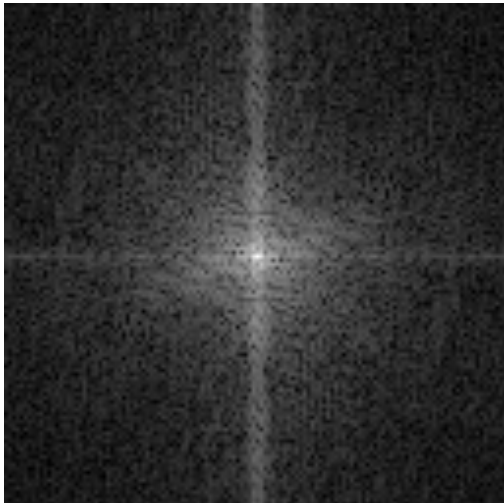

More filtering examples

original image

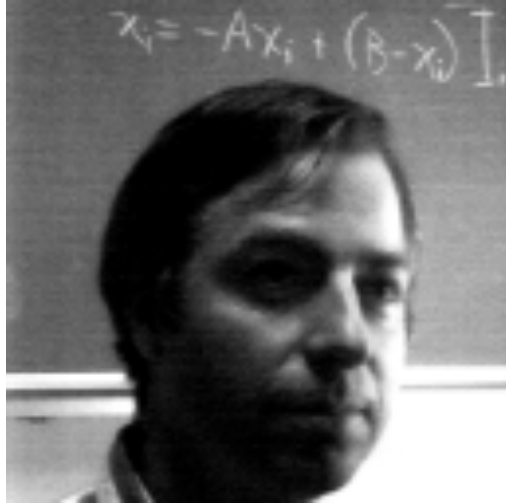

band-pass filter

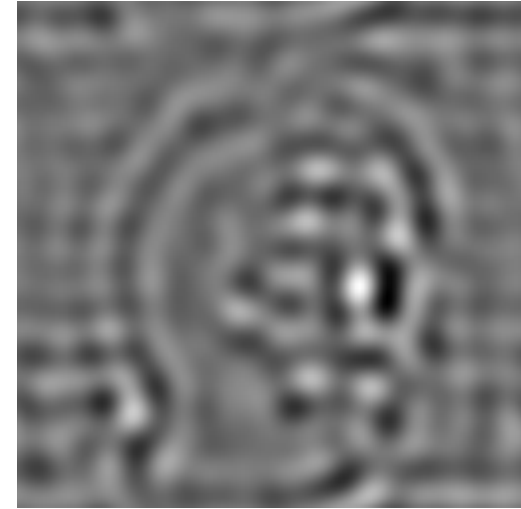
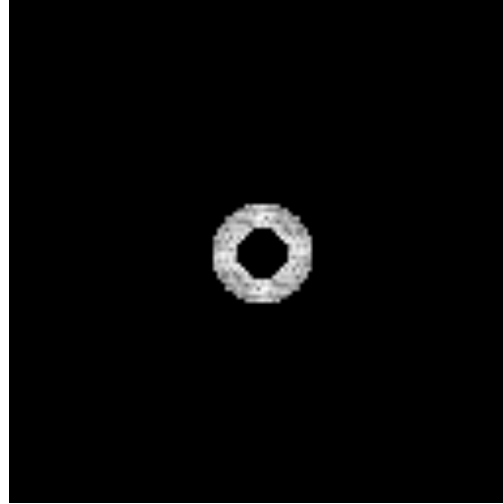

frequency magnitude

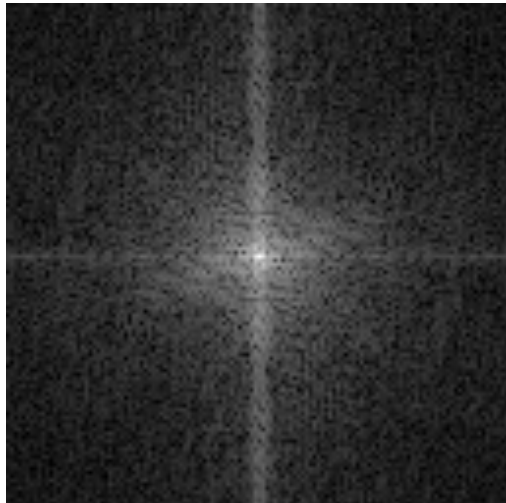

More filtering examples

original image

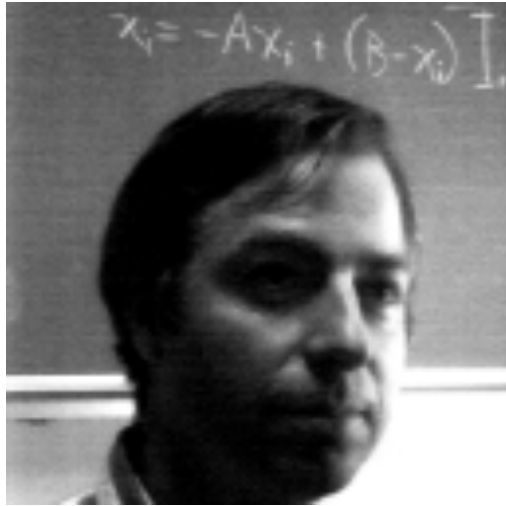

band-pass filter

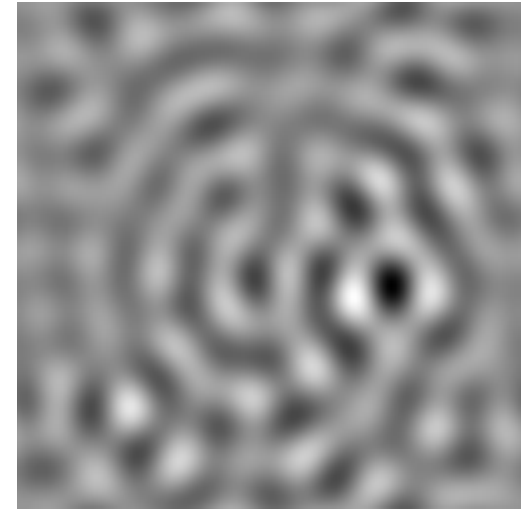
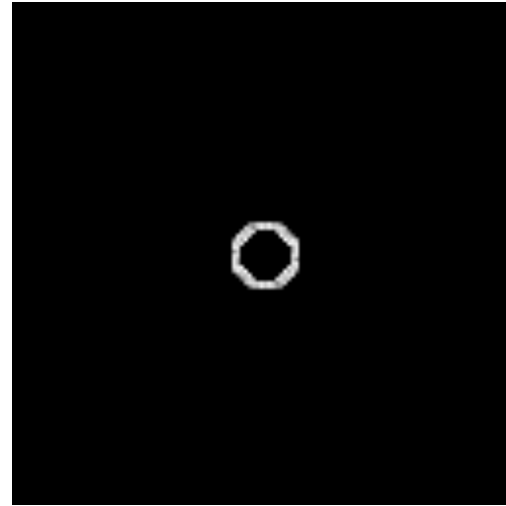

frequency magnitude

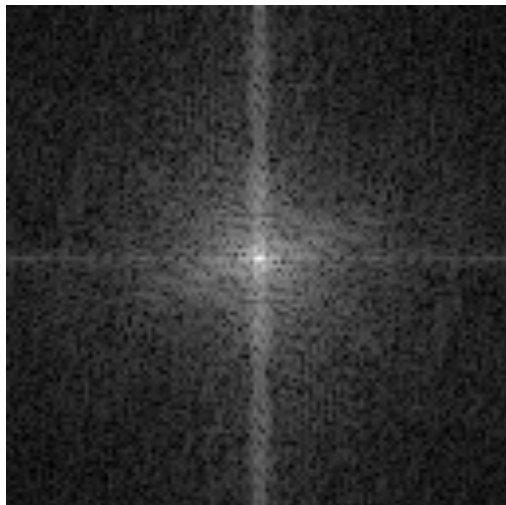

More filtering examples

original image

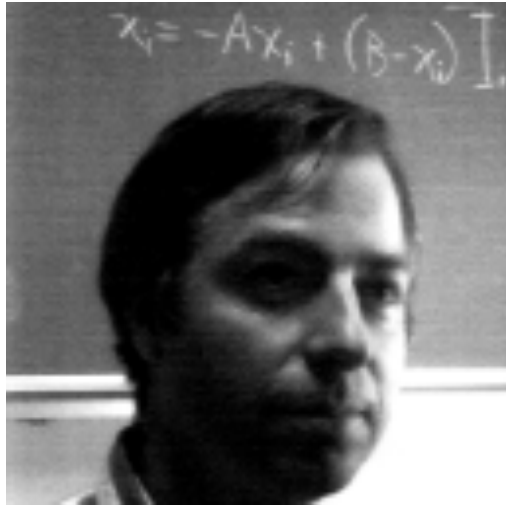

band-pass filter

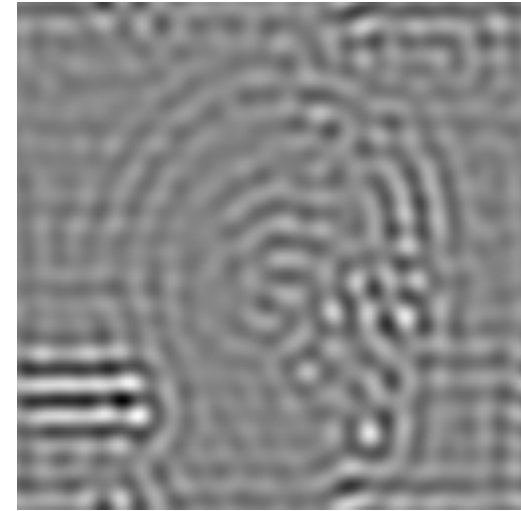
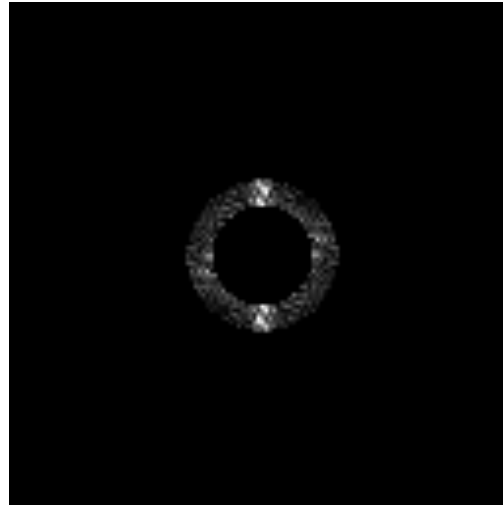

frequency magnitude

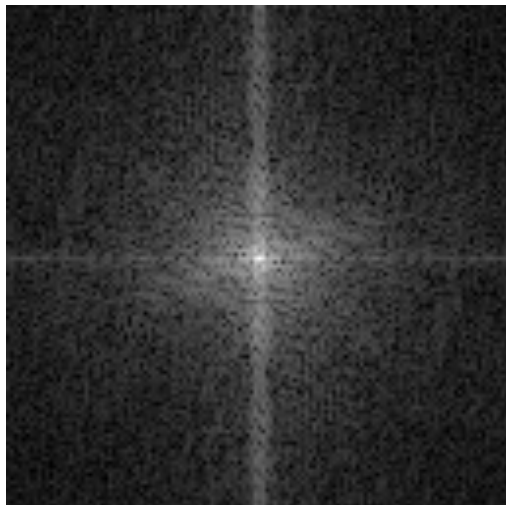

More filtering examples

original image

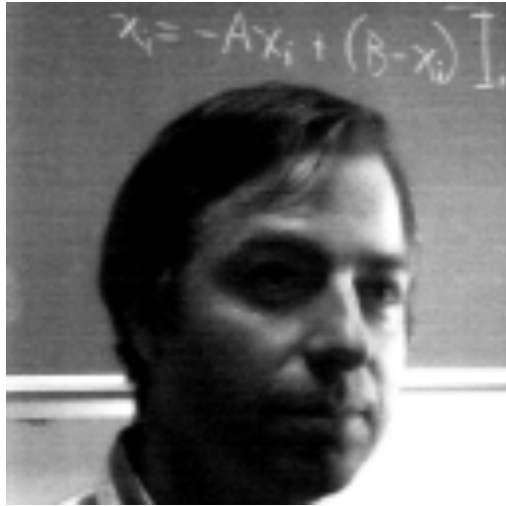

band-pass filter

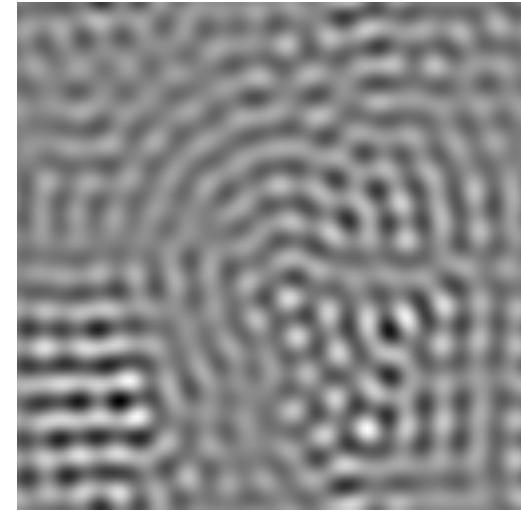
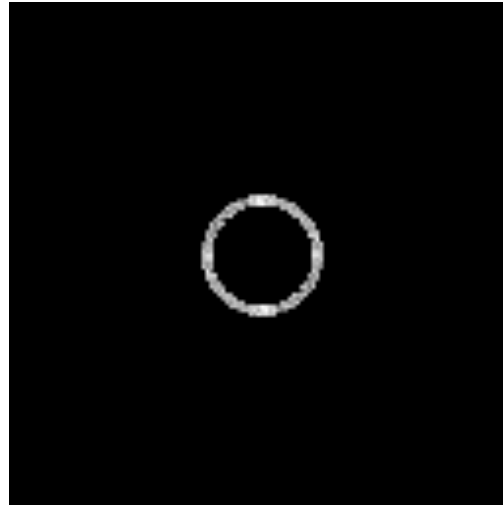

frequency magnitude

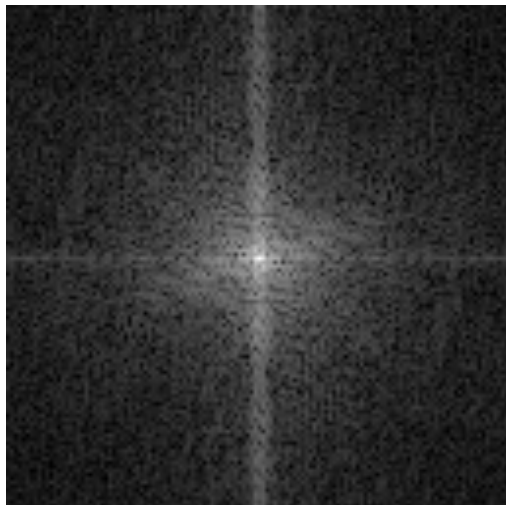

Revisiting sampling

The Nyquist-Shannon sampling theorem

A continuous signal can be perfectly reconstructed from its discrete version using linear interpolation, if sampling occurred with frequency:

$$f_s \geq 2f_{\max} \quad \leftarrow \text{This is called the Nyquist frequency}$$

Equivalent reformulation: When downsampling, aliasing does not occur if samples are taken at the Nyquist frequency or higher.

Gaussian pyramid

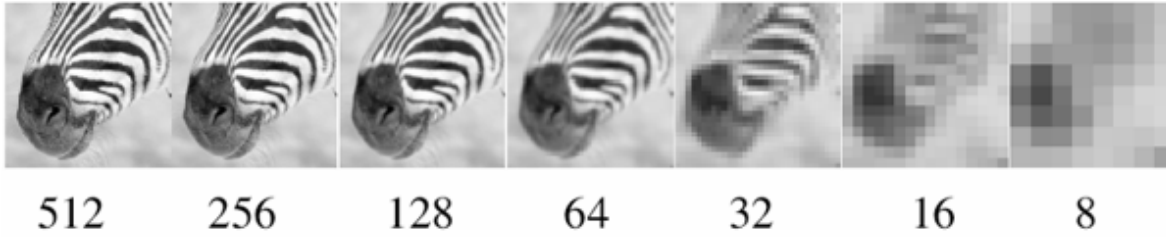

How does the Nyquist-Shannon theorem relate to the Gaussian pyramid?



Gaussian pyramid

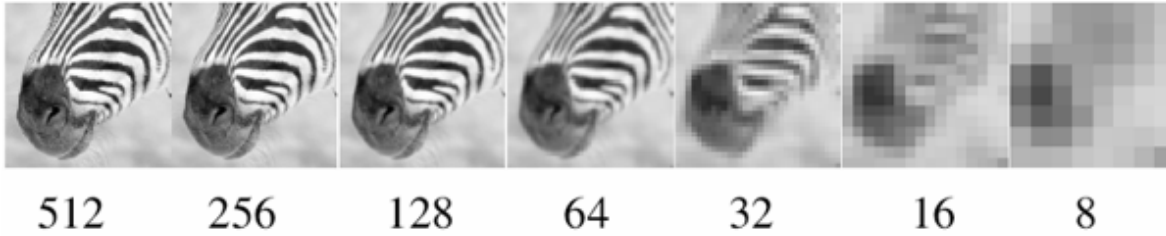

How does the Nyquist-Shannon theorem relate to the Gaussian pyramid?

- Gaussian blurring is low-pass filtering.
- By blurring we try to sufficiently decrease the Nyquist frequency to avoid aliasing.

How large should the Gauss blur we use be?

Frequency-domain filtering in human vision



“Hybrid image”

Aude Oliva and Philippe Schyns

Frequency-domain filtering in human vision

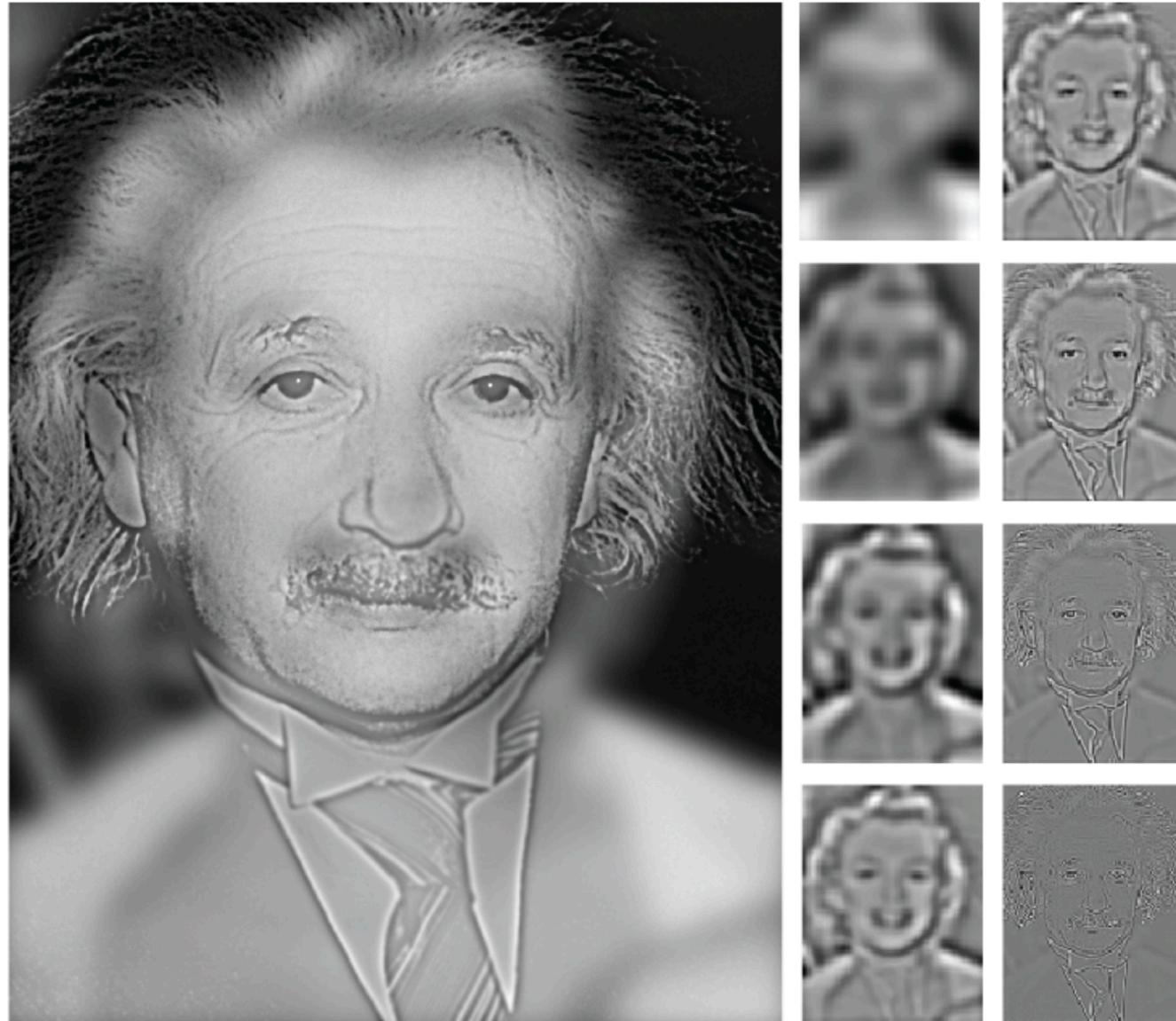

Variable frequency sensitivity

Experiment: Where do you see the stripes?

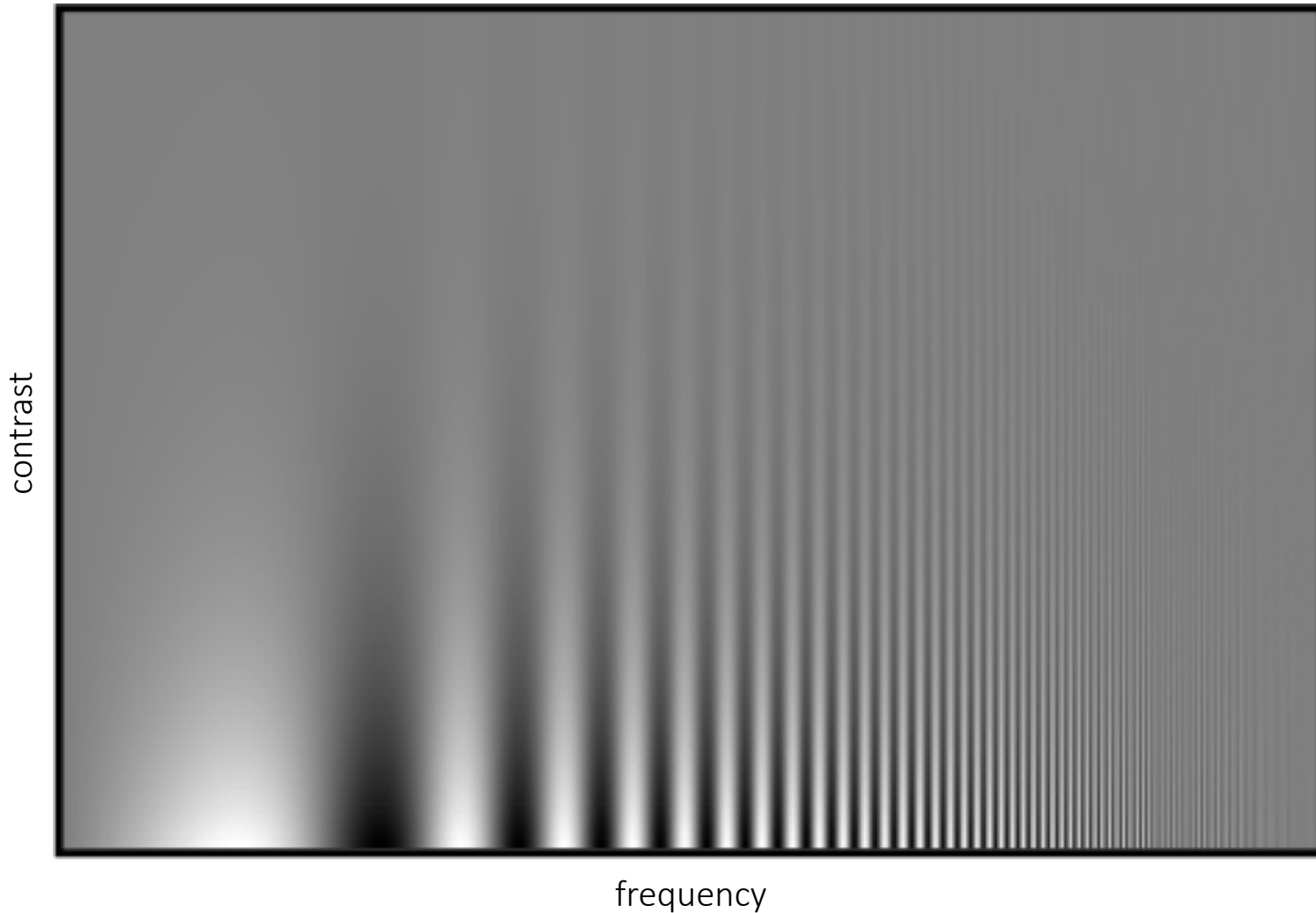

Variable frequency sensitivity

Campbell-Robson contrast sensitivity curve

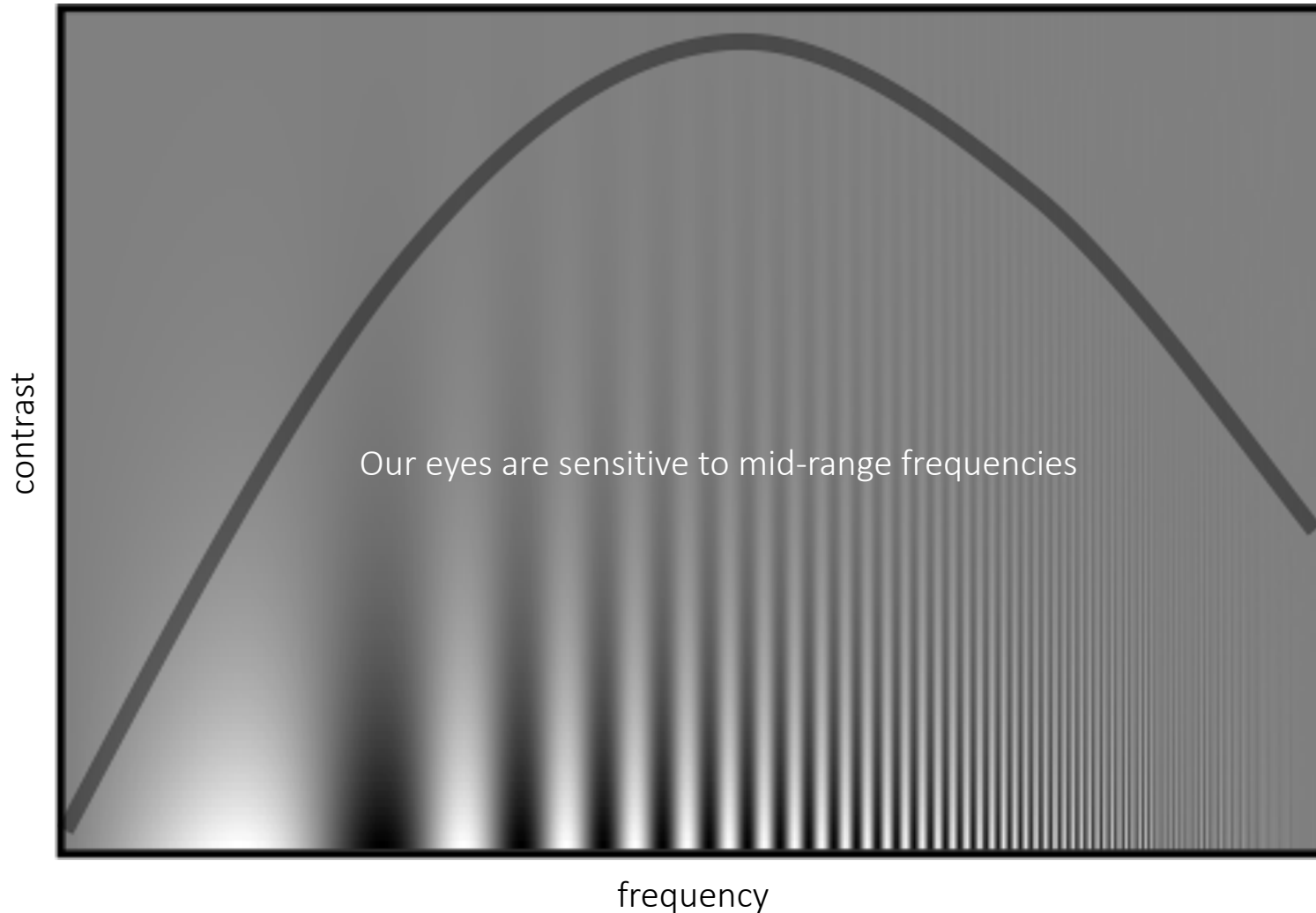

- Early processing in humans filters for various orientations and scales of frequency
- Perceptual cues in the mid frequencies dominate perception