

Two-view geometry

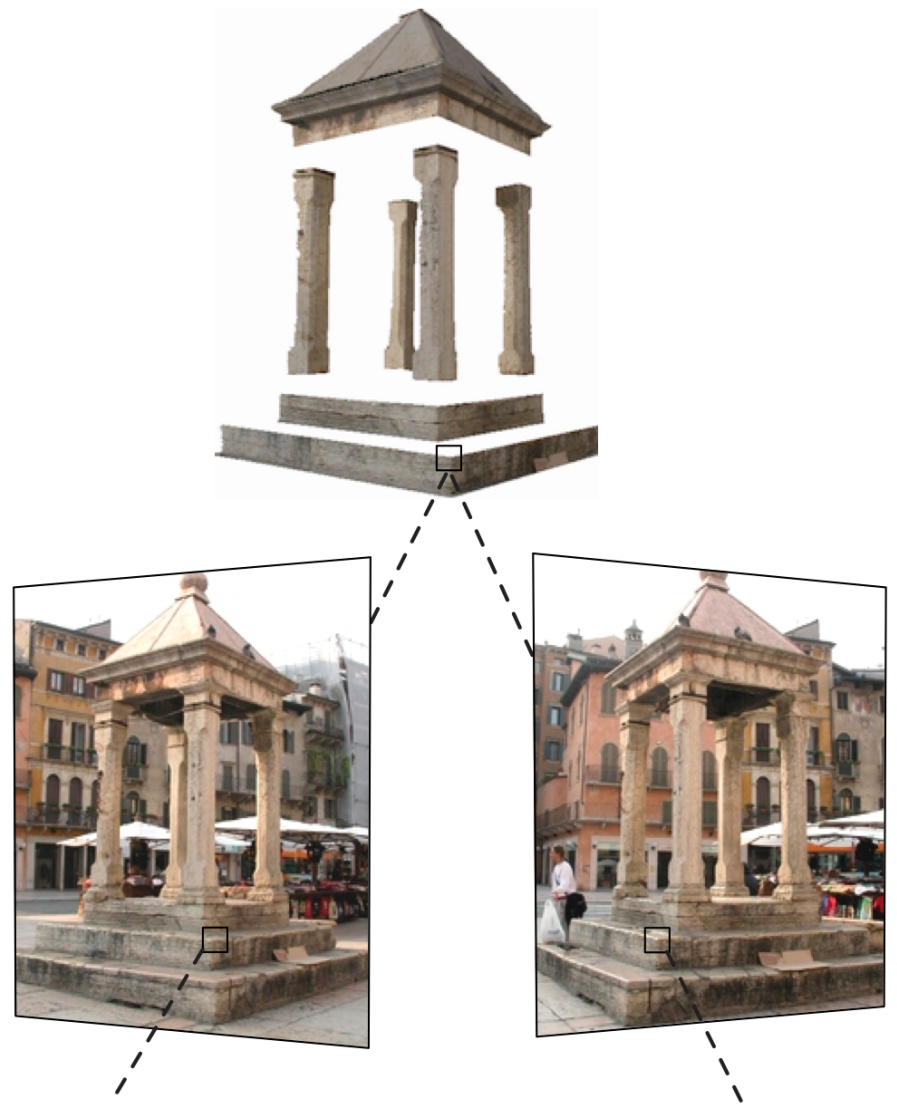

Overview of today's lecture

- Triangulation.
- Epipolar geometry.
- Essential matrix.
- Fundamental matrix.
- 8-point algorithm.

Slide credits

Many of these slides were adapted from:

- Kris Kitani (16-385, Spring 2017).
- Srinivasa Narasimhan (16-720, Fall 2017).

Triangulation

Triangulation

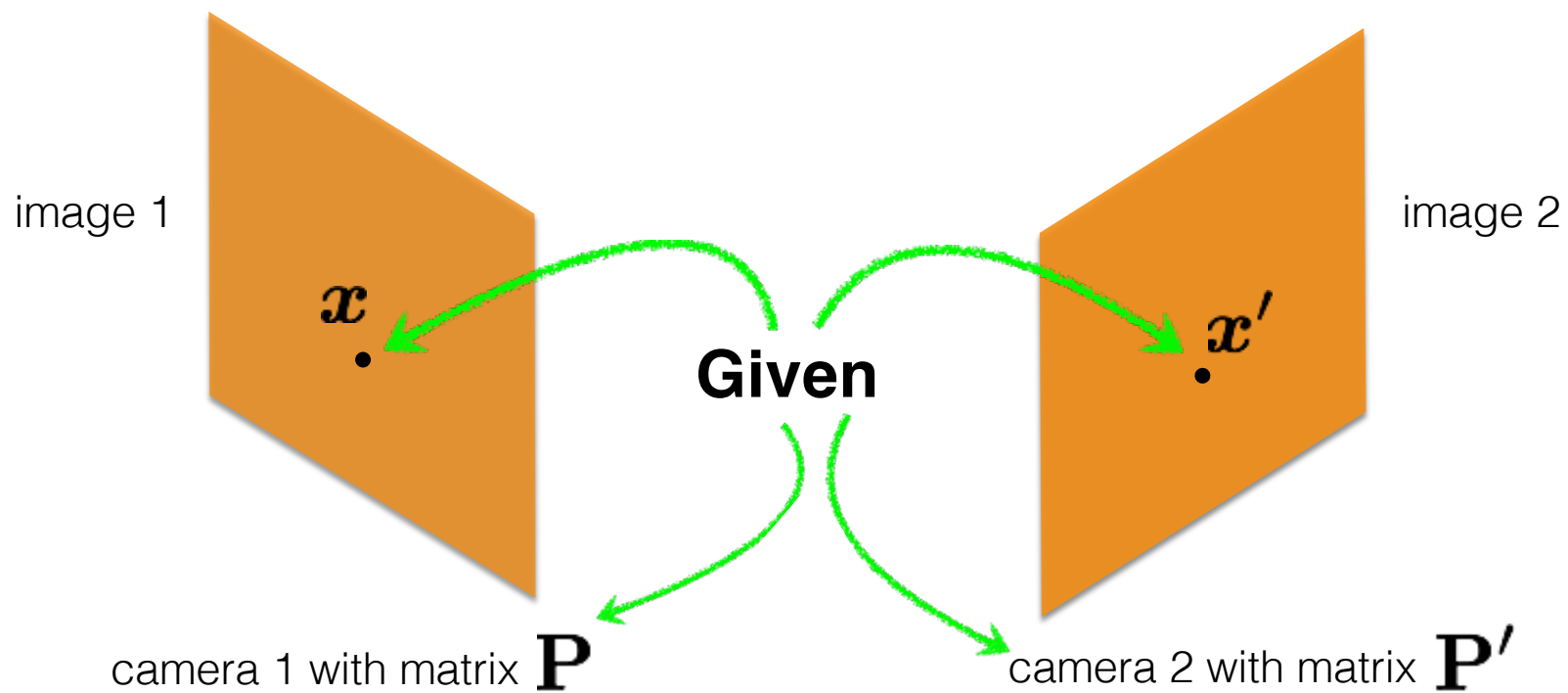

Triangulation

Which 3D points map
to x ?

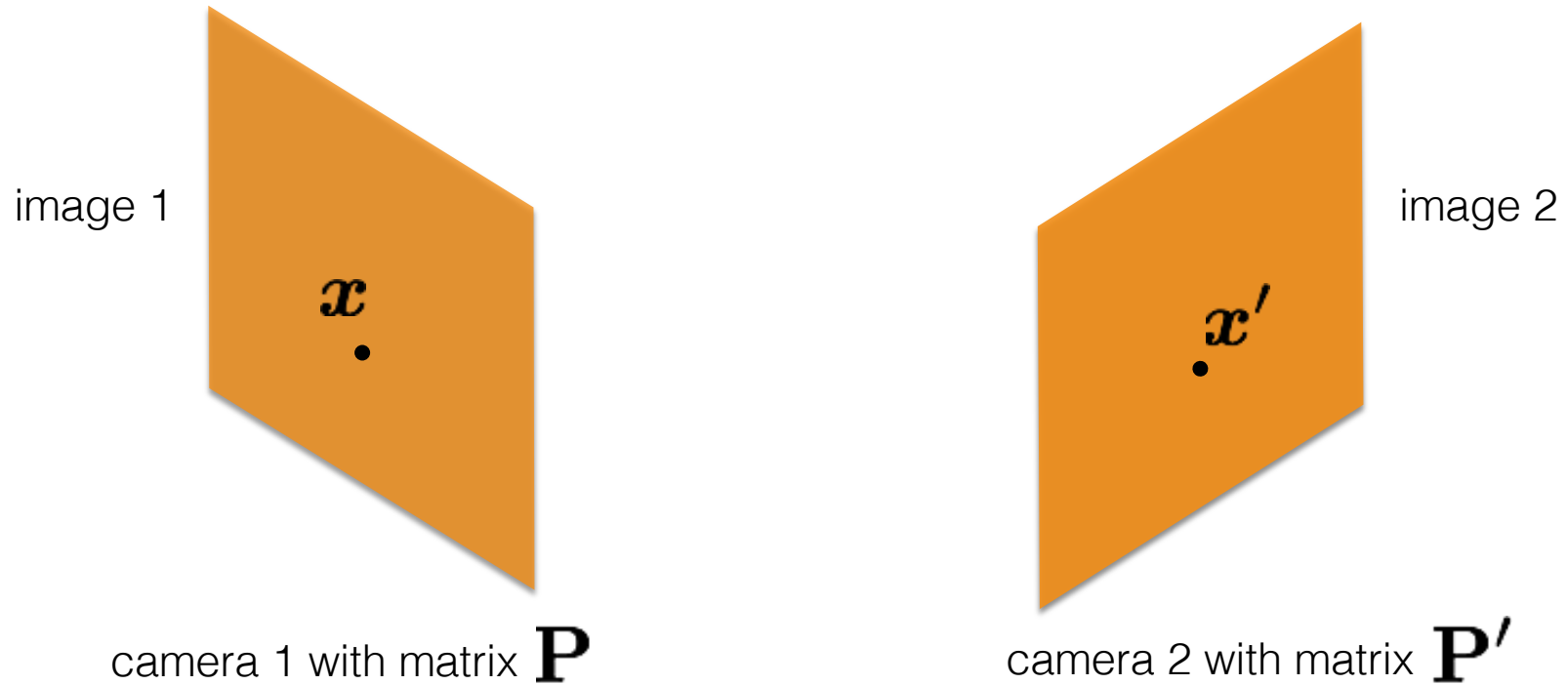

Triangulation

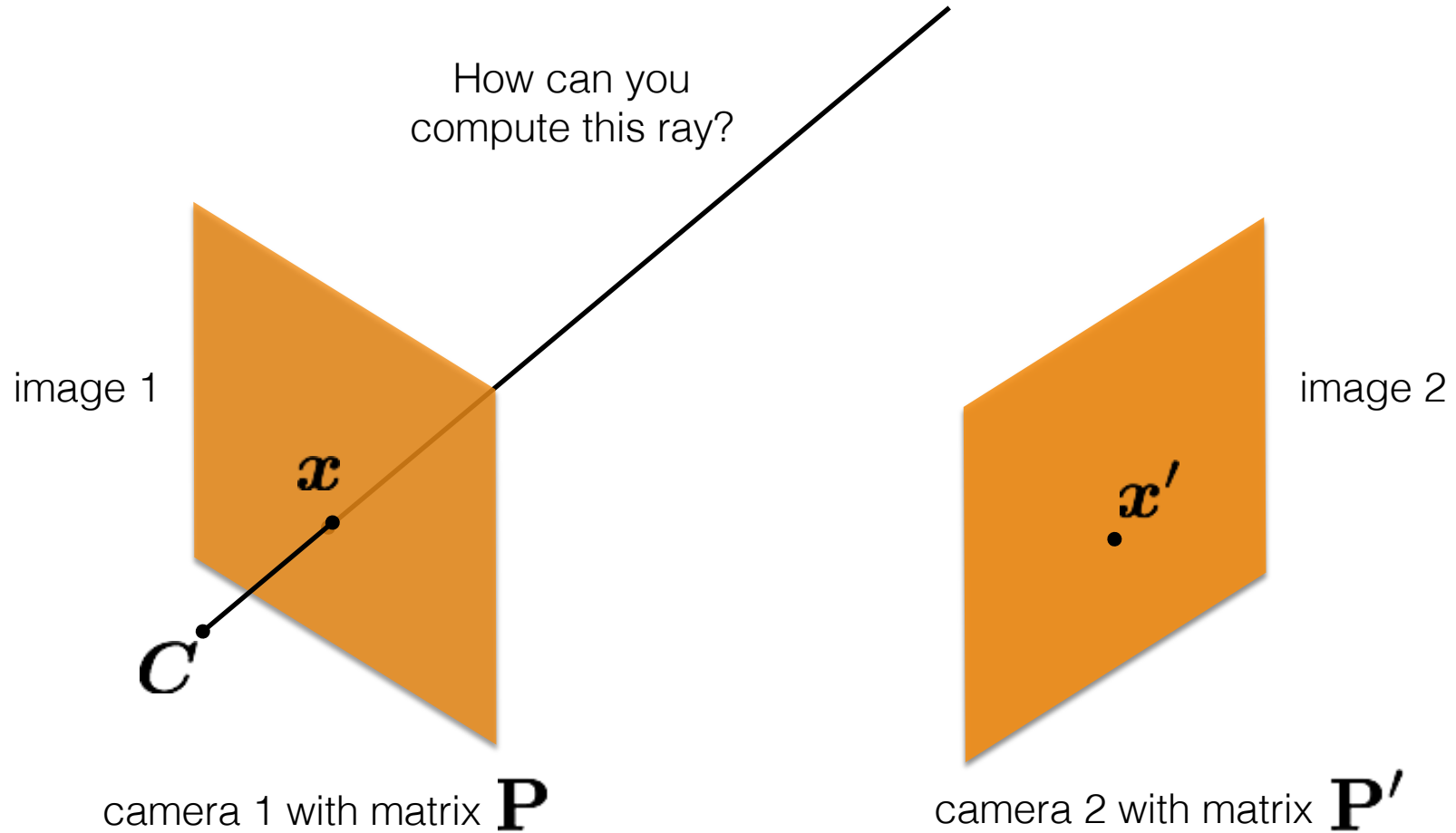

Triangulation

Create two points on the ray:

- 1) find the camera center; and
 - 2) apply the pseudo-inverse of \mathbf{P} on \mathbf{x} .
- Then connect the two points.

This procedure is called backprojection

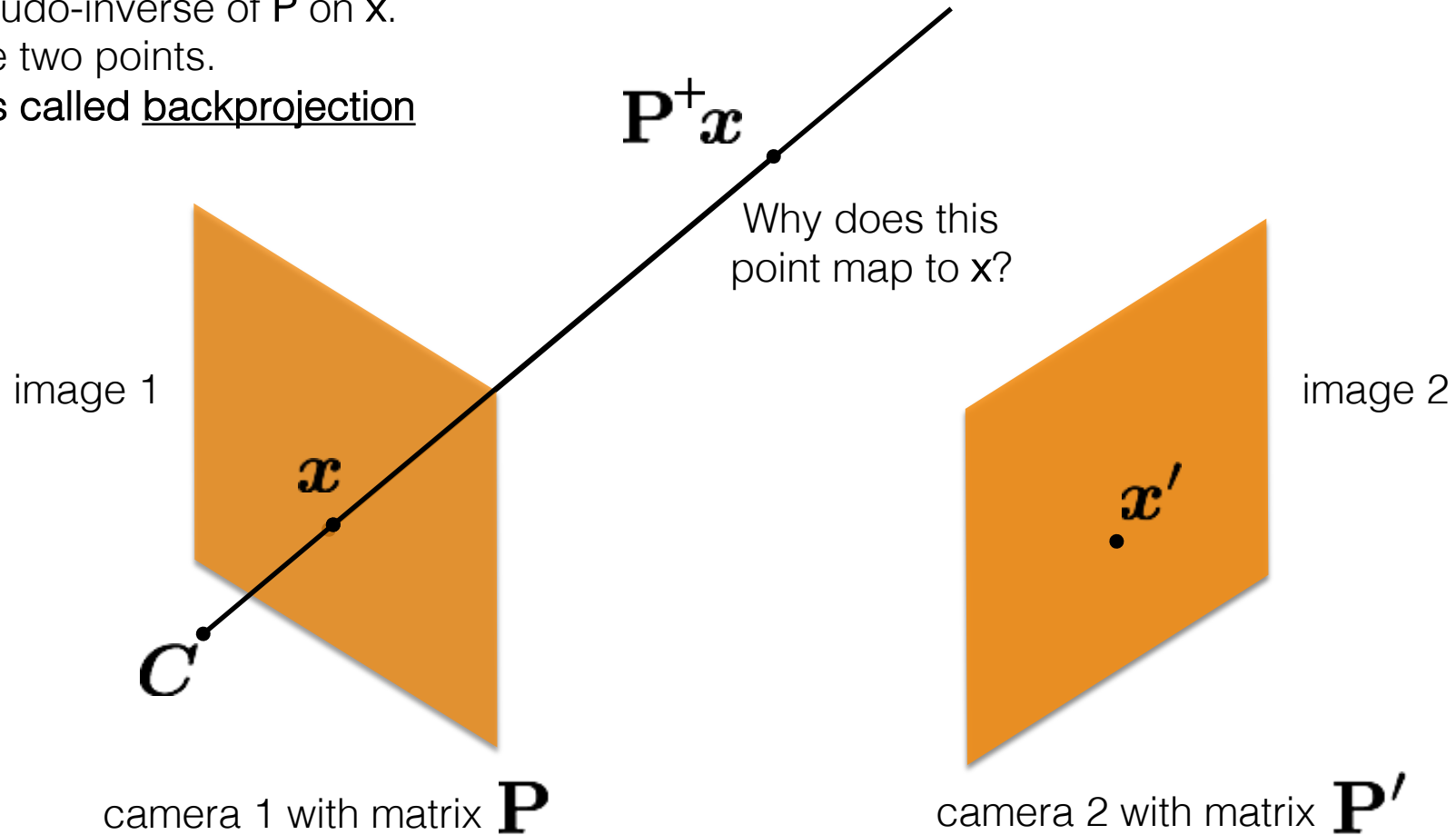

Triangulation

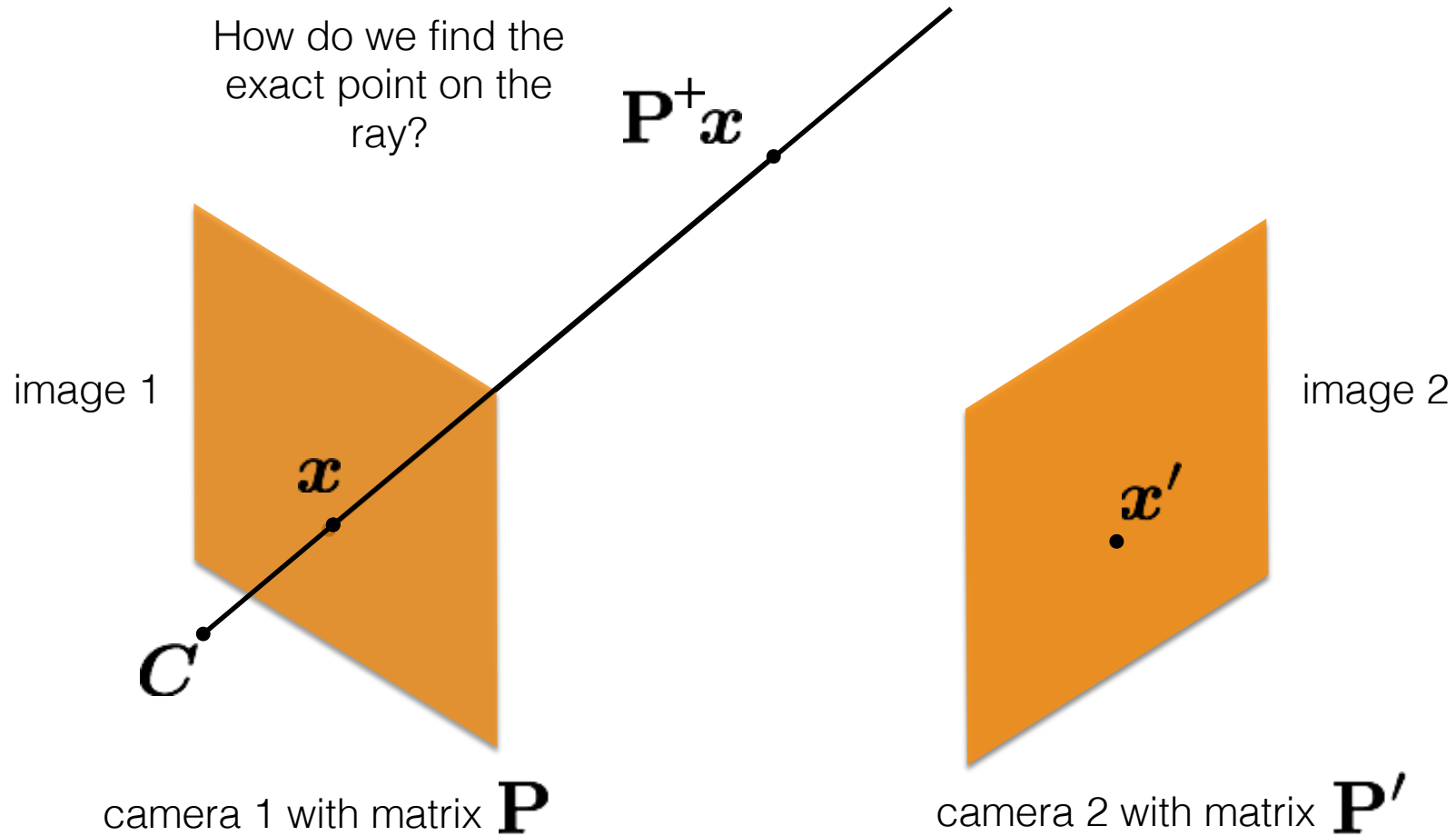

Triangulation

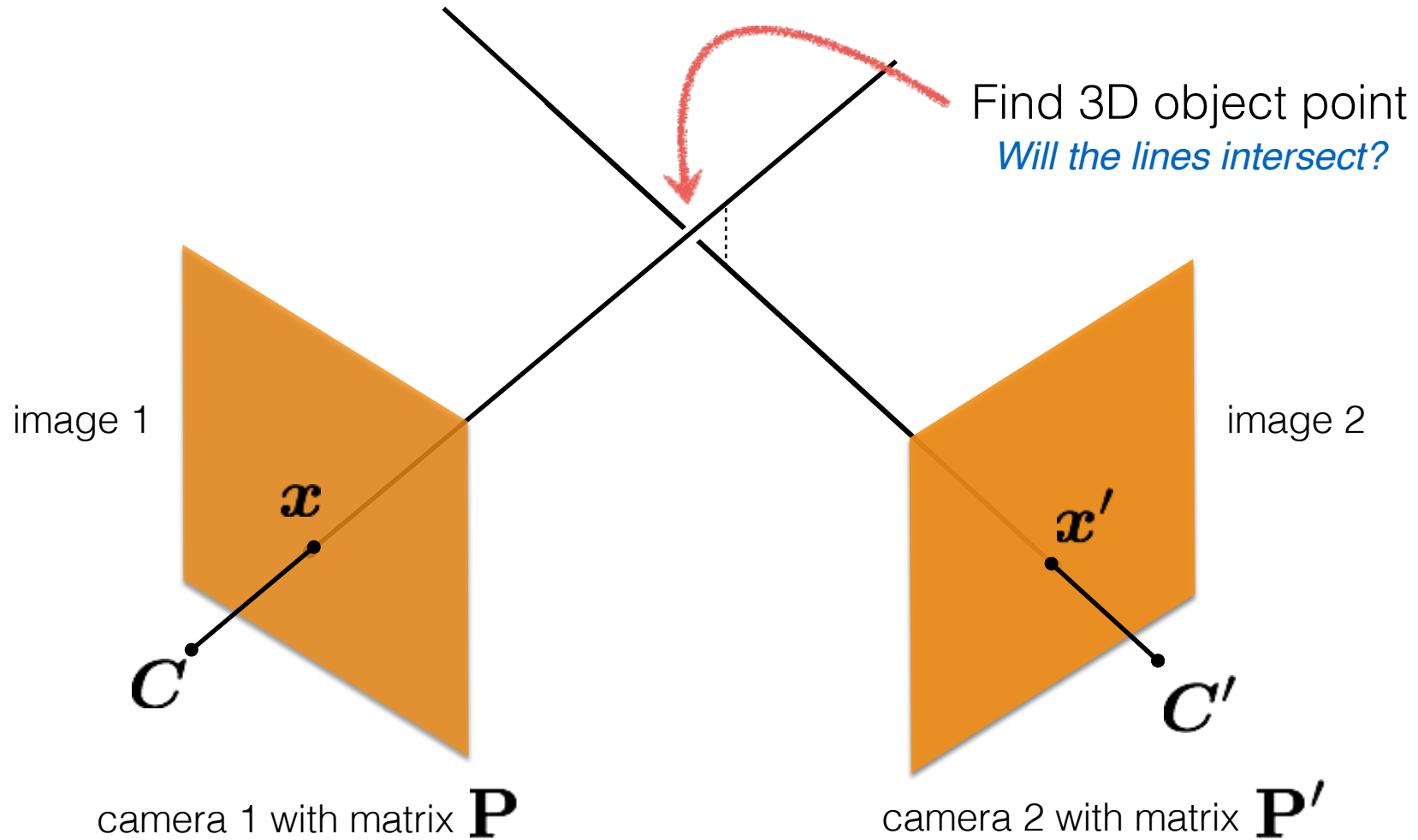

Triangulation

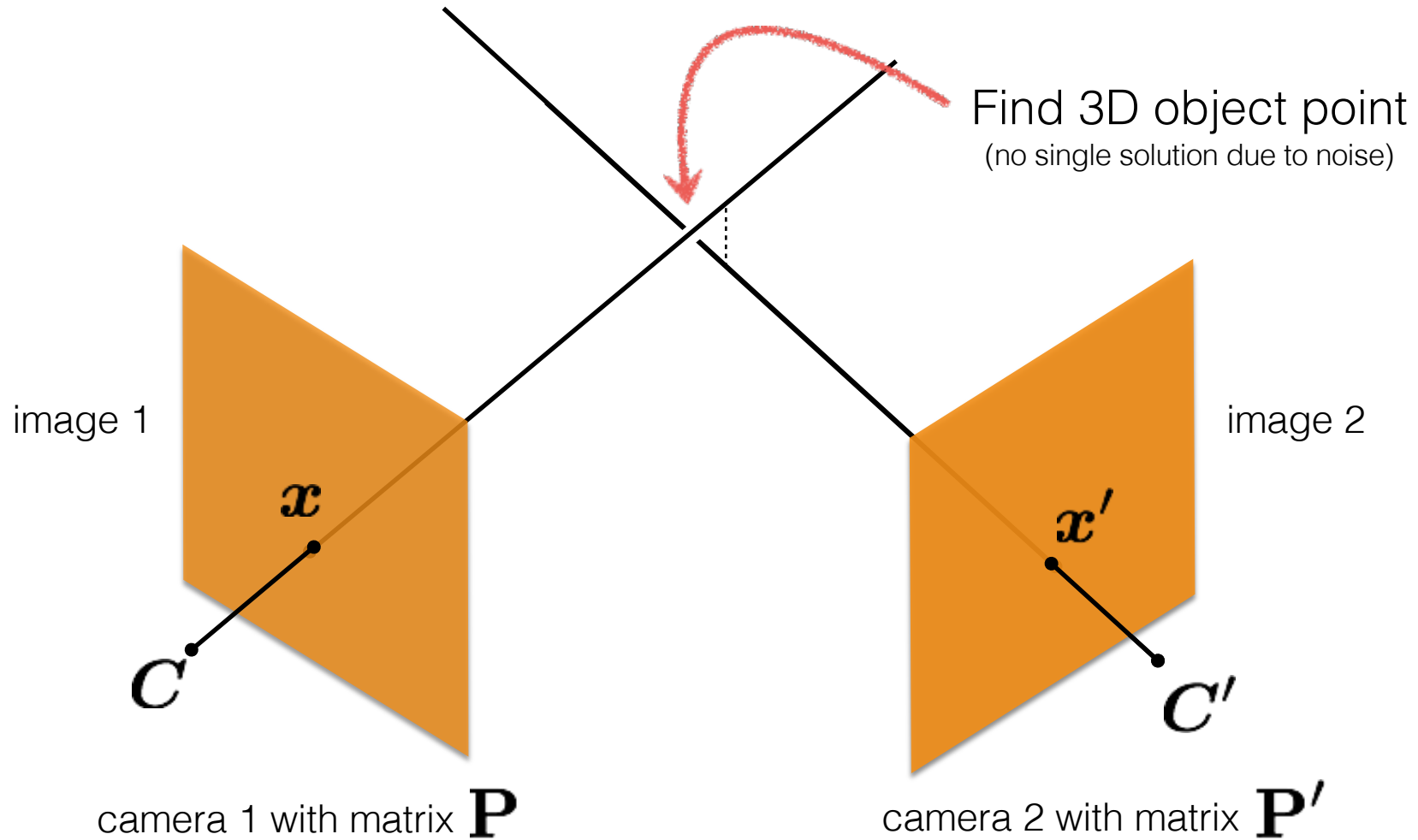

Triangulation

Given a set of (noisy) matched points

$$\{\mathbf{x}_i, \mathbf{x}'_i\}$$

and camera matrices

$$\mathbf{P}, \mathbf{P}'$$

Estimate the 3D point

$$\mathbf{X}$$

$$\mathbf{x} = \mathbf{P}\mathbf{X}$$

known

known

*Can we compute \mathbf{X} from a single
correspondence \mathbf{x} ?*

$$\mathbf{x} = \mathbf{P}\mathbf{X}$$

(homogeneous
coordinate)

This is a similarity relation because it involves homogeneous coordinates

$$\mathbf{x} = \alpha\mathbf{P}\mathbf{X}$$

(heterogeneous
coordinate)

Same ray direction but differs by a scale factor

$$\begin{bmatrix} x \\ y \\ z \end{bmatrix} = \alpha \begin{bmatrix} p_1 & p_2 & p_3 & p_4 \\ p_5 & p_6 & p_7 & p_8 \\ p_9 & p_{10} & p_{11} & p_{12} \end{bmatrix} \begin{bmatrix} X \\ Y \\ Z \\ 1 \end{bmatrix}$$

How do we solve for unknowns in a similarity relation?

Linear algebra reminder: cross product

Vector (cross) product

takes two vectors and returns a vector perpendicular to both

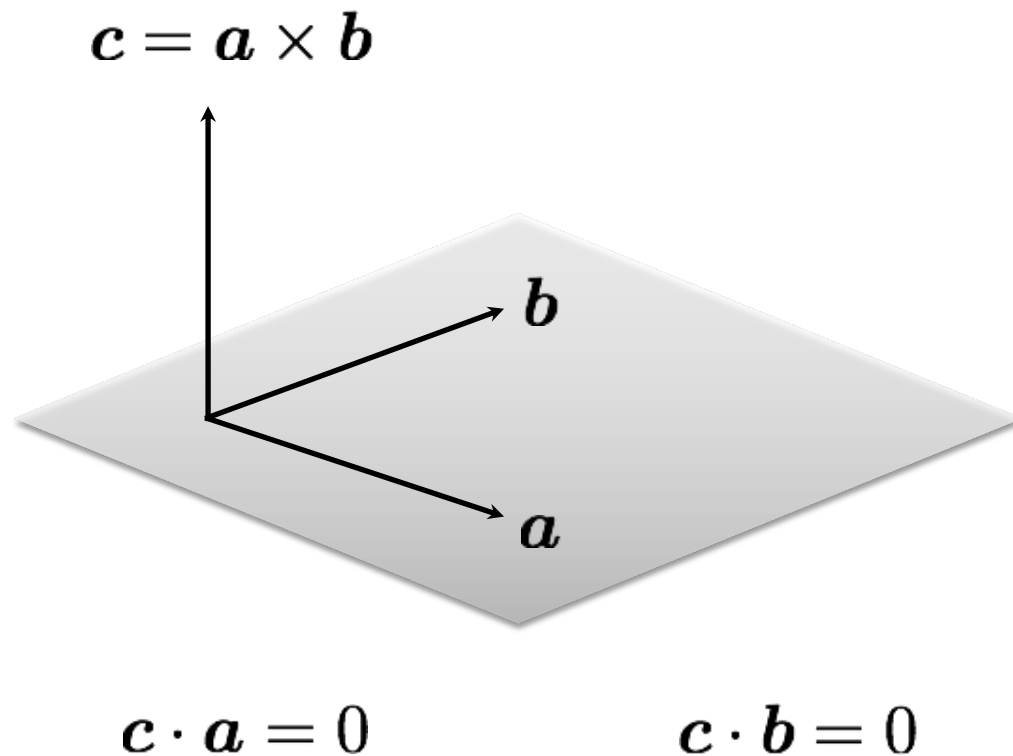

$$a \times b = \begin{bmatrix} a_2b_3 - a_3b_2 \\ a_3b_1 - a_1b_3 \\ a_1b_2 - a_2b_1 \end{bmatrix}$$

cross product of two vectors in
the same direction is zero
vector

$$a \times a = 0$$

remember this!!!

Linear algebra reminder: cross product

Cross product

$$\mathbf{a} \times \mathbf{b} = \begin{bmatrix} a_2 b_3 - a_3 b_2 \\ a_3 b_1 - a_1 b_3 \\ a_1 b_2 - a_2 b_1 \end{bmatrix}$$

Can also be written as a matrix multiplication

$$\mathbf{a} \times \mathbf{b} = [\mathbf{a}]_{\times} \mathbf{b} = \begin{bmatrix} 0 & -a_3 & a_2 \\ a_3 & 0 & -a_1 \\ -a_2 & a_1 & 0 \end{bmatrix} \begin{bmatrix} b_1 \\ b_2 \\ b_3 \end{bmatrix}$$

Skew symmetric

Compare with: dot product

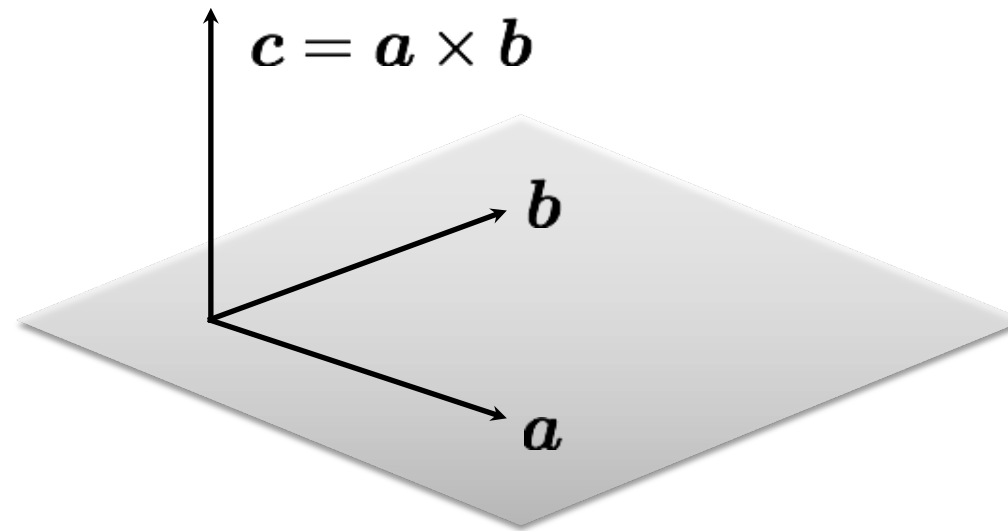

$$c \cdot a = 0$$

$$c \cdot b = 0$$

dot product of two orthogonal vectors is (scalar) zero

Back to triangulation

$$\mathbf{x} = \alpha \mathbf{P} \mathbf{X}$$

Same direction but differs by a scale factor

How can we rewrite this using vector products?

$$\mathbf{x} = \alpha \mathbf{P} \mathbf{X}$$

Same direction but differs by a scale factor

$$\mathbf{x} \times \mathbf{P} \mathbf{X} = \mathbf{0}$$

Cross product of two vectors of same direction is zero
(this equality removes the scale factor)

$$\begin{bmatrix} x \\ y \\ z \end{bmatrix} = \alpha \begin{bmatrix} p_1 & p_2 & p_3 & p_4 \\ p_5 & p_6 & p_7 & p_8 \\ p_9 & p_{10} & p_{11} & p_{12} \end{bmatrix} \begin{bmatrix} X \\ Y \\ Z \\ 1 \end{bmatrix}$$

$$\begin{bmatrix} x \\ y \\ z \end{bmatrix} = \alpha \begin{bmatrix} \text{---} & \mathbf{p}_1^\top & \text{---} \\ \text{---} & \mathbf{p}_2^\top & \text{---} \\ \text{---} & \mathbf{p}_3^\top & \text{---} \end{bmatrix} \begin{bmatrix} | \\ \mathbf{X} \\ | \end{bmatrix}$$

Do the same after first
expanding out the
camera matrix and points

$$\begin{bmatrix} x \\ y \\ z \end{bmatrix} = \alpha \begin{bmatrix} \mathbf{p}_1^\top \mathbf{X} \\ \mathbf{p}_2^\top \mathbf{X} \\ \mathbf{p}_3^\top \mathbf{X} \end{bmatrix}$$

$$\begin{bmatrix} x \\ y \\ 1 \end{bmatrix} \times \begin{bmatrix} \mathbf{p}_1^\top \mathbf{X} \\ \mathbf{p}_2^\top \mathbf{X} \\ \mathbf{p}_3^\top \mathbf{X} \end{bmatrix} = \begin{bmatrix} y\mathbf{p}_3^\top \mathbf{X} - \mathbf{p}_2^\top \mathbf{X} \\ \mathbf{p}_1^\top \mathbf{X} - x\mathbf{p}_3^\top \mathbf{X} \\ x\mathbf{p}_2^\top \mathbf{X} - y\mathbf{p}_1^\top \mathbf{X} \end{bmatrix} = \begin{bmatrix} 0 \\ 0 \\ 0 \end{bmatrix}$$

Using the fact that the cross product should be zero

$$\mathbf{x} \times \mathbf{P}\mathbf{X} = \mathbf{0}$$

$$\begin{bmatrix} yp_3^\top \mathbf{X} - p_2^\top \mathbf{X} \\ p_1^\top \mathbf{X} - xp_3^\top \mathbf{X} \\ xp_2^\top \mathbf{X} - yp_1^\top \mathbf{X} \end{bmatrix} = \begin{bmatrix} 0 \\ 0 \\ 0 \end{bmatrix}$$

Third line is a linear combination of the first and second lines.
(x times the first line plus y times the second line)

One 2D to 3D point correspondence give you  equations

Using the fact that the cross product should be zero

$$\mathbf{x} \times \mathbf{P}\mathbf{X} = \mathbf{0}$$

$$\begin{bmatrix} yp_3^\top \mathbf{X} - p_2^\top \mathbf{X} \\ p_1^\top \mathbf{X} - xp_3^\top \mathbf{X} \\ xp_2^\top \mathbf{X} - yp_1^\top \mathbf{X} \end{bmatrix} = \begin{bmatrix} 0 \\ 0 \\ 0 \end{bmatrix}$$

Third line is a linear combination of the first and second lines.
(x times the first line plus y times the second line)

One 2D to 3D point correspondence give you 2 equations

$$\begin{bmatrix} y\mathbf{p}_3^\top \mathbf{X} - \mathbf{p}_2^\top \mathbf{X} \\ \mathbf{p}_1^\top \mathbf{X} - x\mathbf{p}_3^\top \mathbf{X} \end{bmatrix} = \begin{bmatrix} 0 \\ 0 \end{bmatrix}$$

Remove third row, and
rearrange as system on
unknowns

$$\begin{bmatrix} y\mathbf{p}_3^\top - \mathbf{p}_2^\top \\ \mathbf{p}_1^\top - x\mathbf{p}_3^\top \end{bmatrix} \mathbf{X} = \begin{bmatrix} 0 \\ 0 \end{bmatrix}$$

$$\mathbf{A}_i \mathbf{X} = \mathbf{0}$$

Now we can make a system of linear equations
(two lines for each 2D point correspondence)

Concatenate the 2D points from both images

Two rows from
camera one

Two rows from
camera two

$$\begin{bmatrix} y\mathbf{p}_3^\top - \mathbf{p}_2^\top \\ \mathbf{p}_1^\top - x\mathbf{p}_3^\top \\ y'\mathbf{p}'_3{}^\top - \mathbf{p}'_2{}^\top \\ \mathbf{p}'_1{}^\top - x'\mathbf{p}'_3{}^\top \end{bmatrix} \mathbf{X} = \begin{bmatrix} 0 \\ 0 \\ 0 \\ 0 \end{bmatrix}$$

sanity check! dimensions?

$$\mathbf{A}\mathbf{X} = \mathbf{0}$$

How do we solve homogeneous linear system?

Concatenate the 2D points from both images

$$\begin{bmatrix} y\mathbf{p}_3^\top - \mathbf{p}_2^\top \\ \mathbf{p}_1^\top - x\mathbf{p}_3^\top \\ y'\mathbf{p}'_3{}^\top - \mathbf{p}'_2{}^\top \\ \mathbf{p}'_1{}^\top - x'\mathbf{p}'_3{}^\top \end{bmatrix} \mathbf{X} = \begin{bmatrix} 0 \\ 0 \\ 0 \\ 0 \end{bmatrix}$$

$$\mathbf{A}\mathbf{X} = \mathbf{0}$$

How do we solve homogeneous linear system?

SVD!

Epipolar geometry

Epipolar geometry

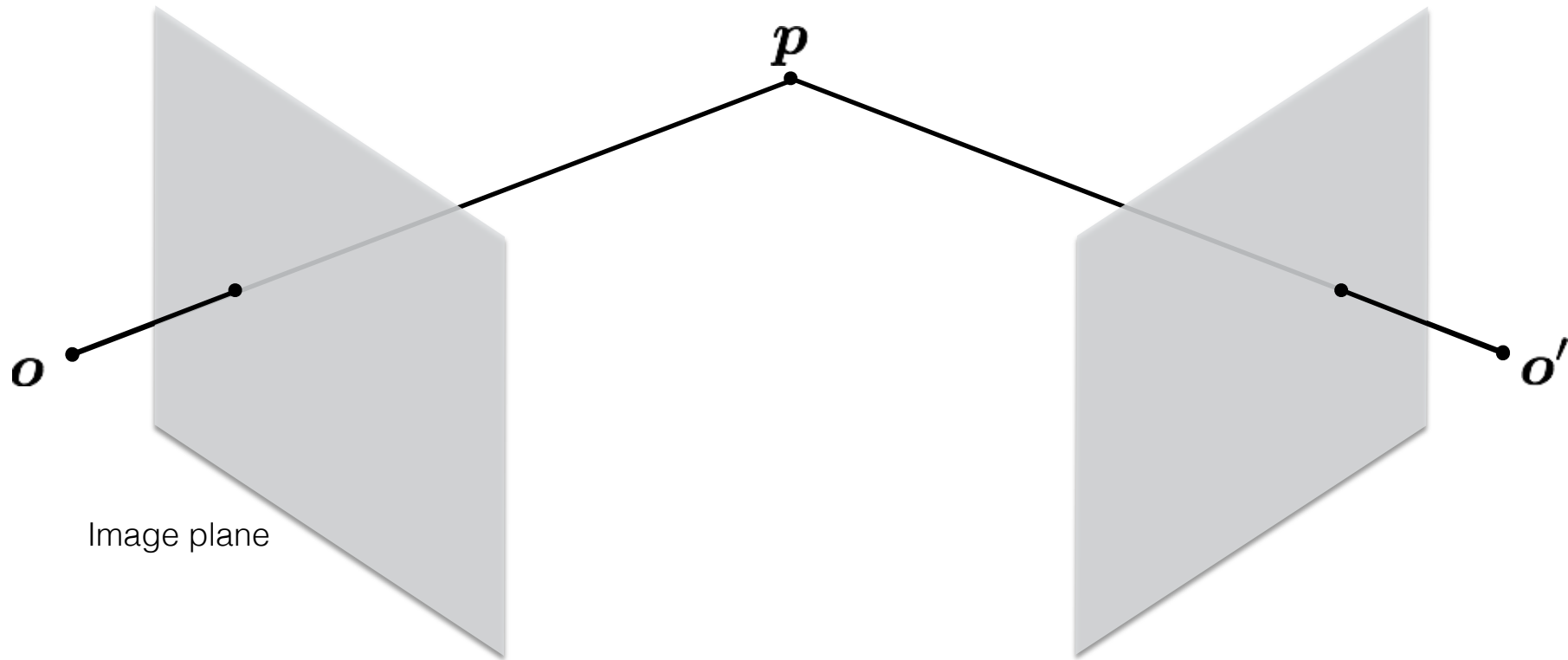

Epipolar geometry

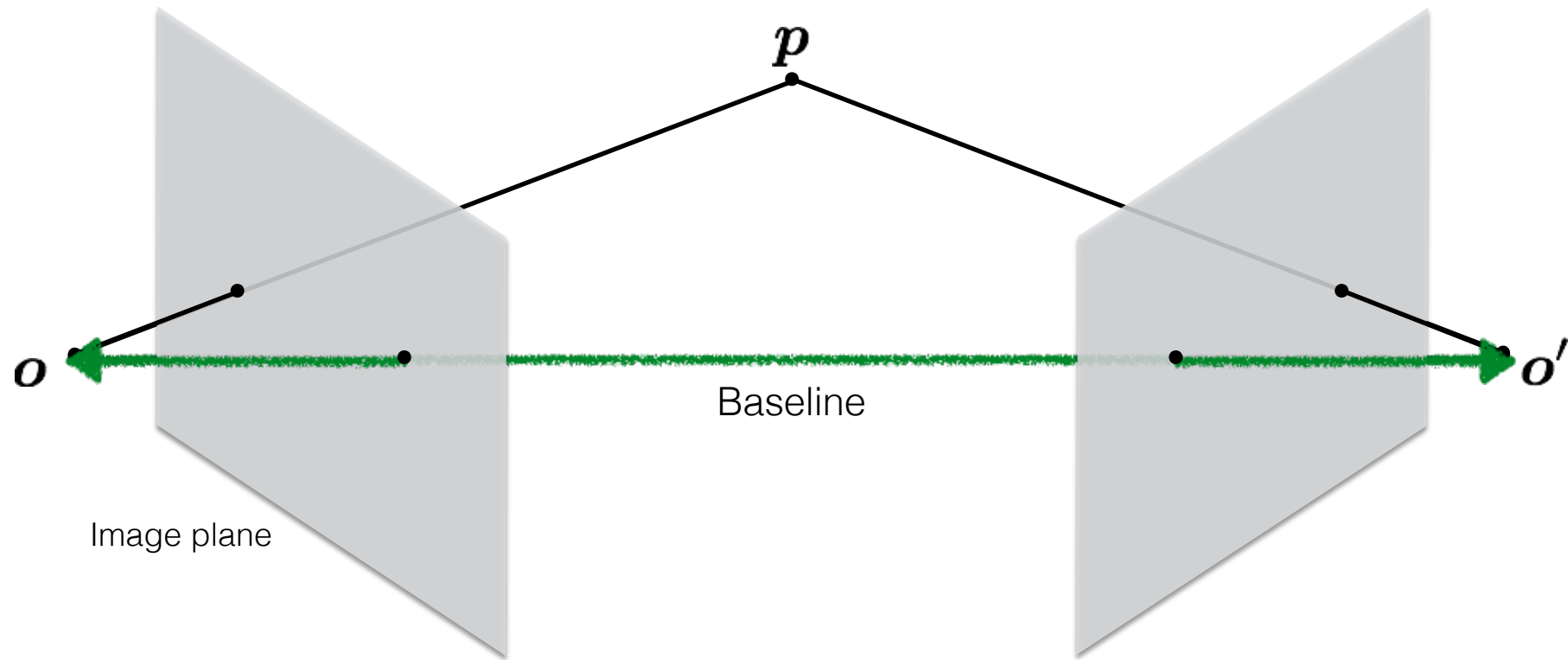

Epipolar geometry

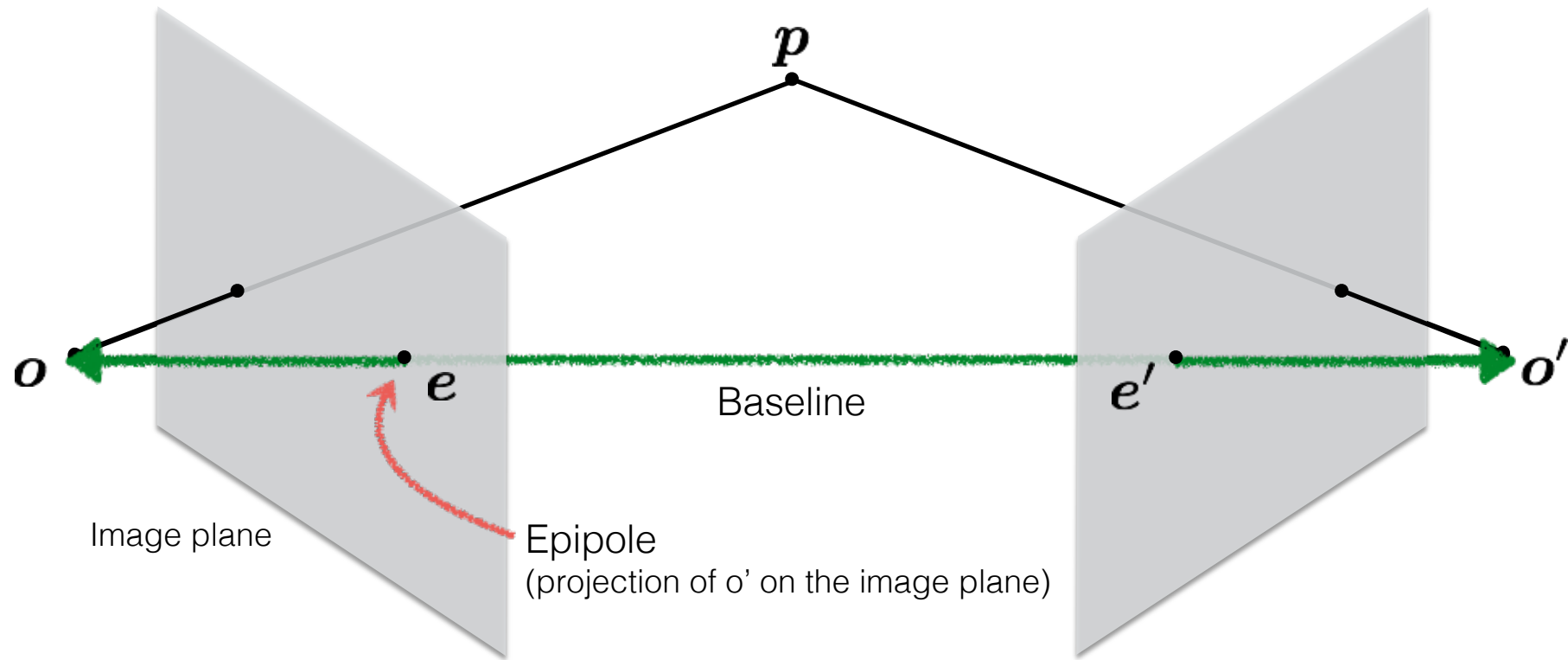

Epipolar geometry

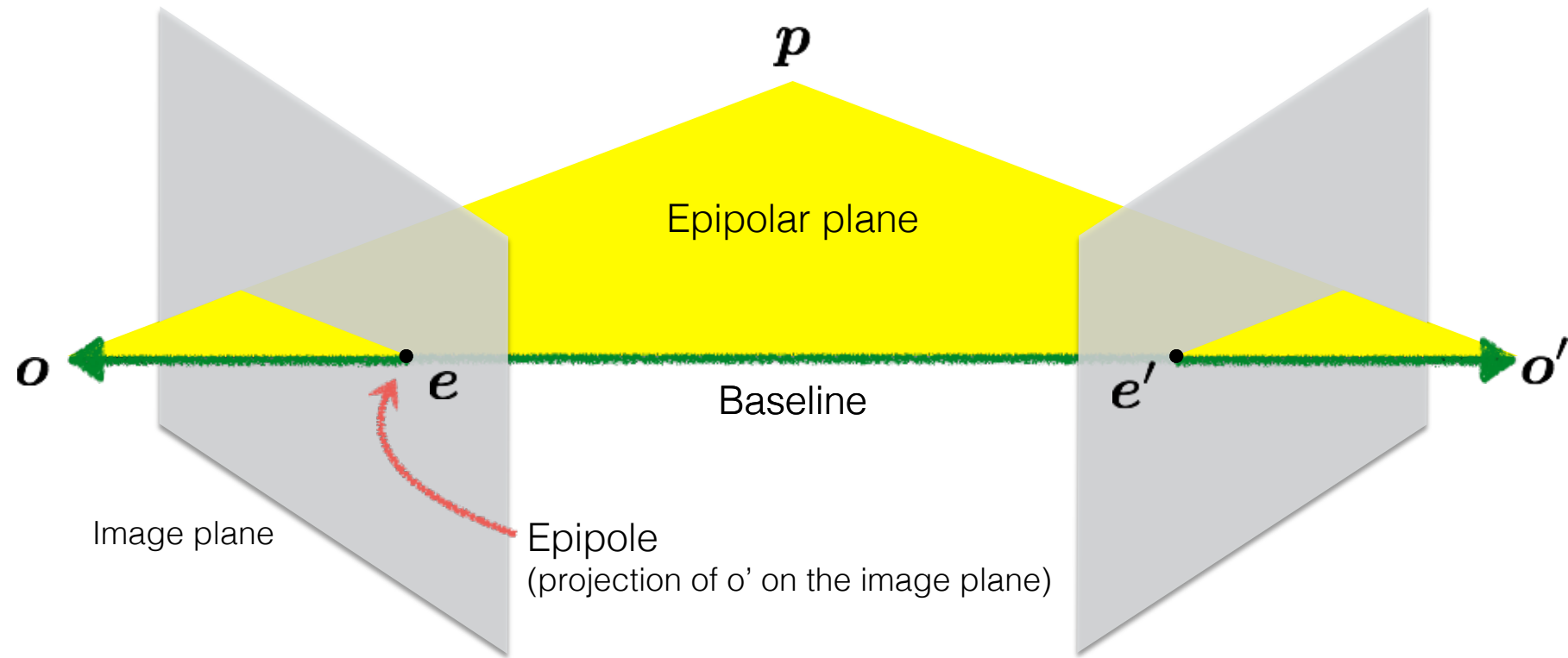

Epipolar geometry

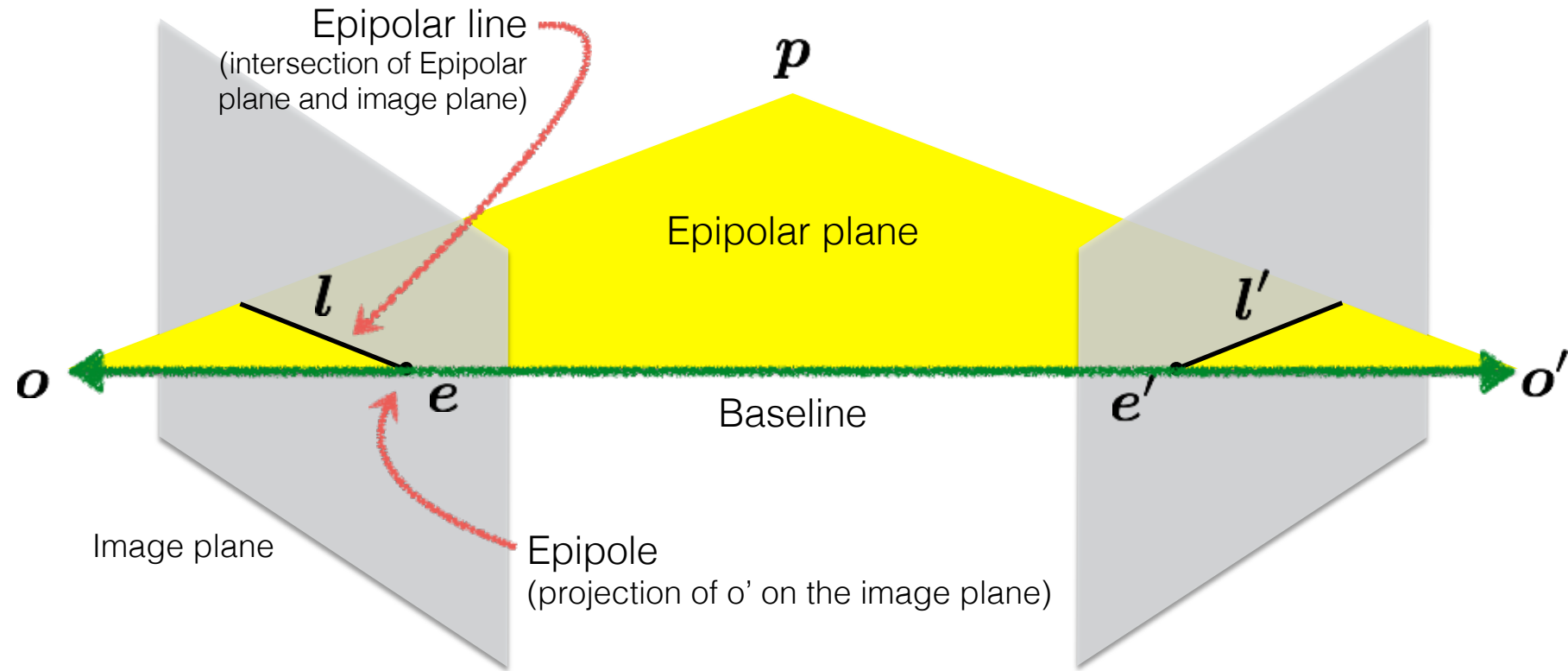

Quiz

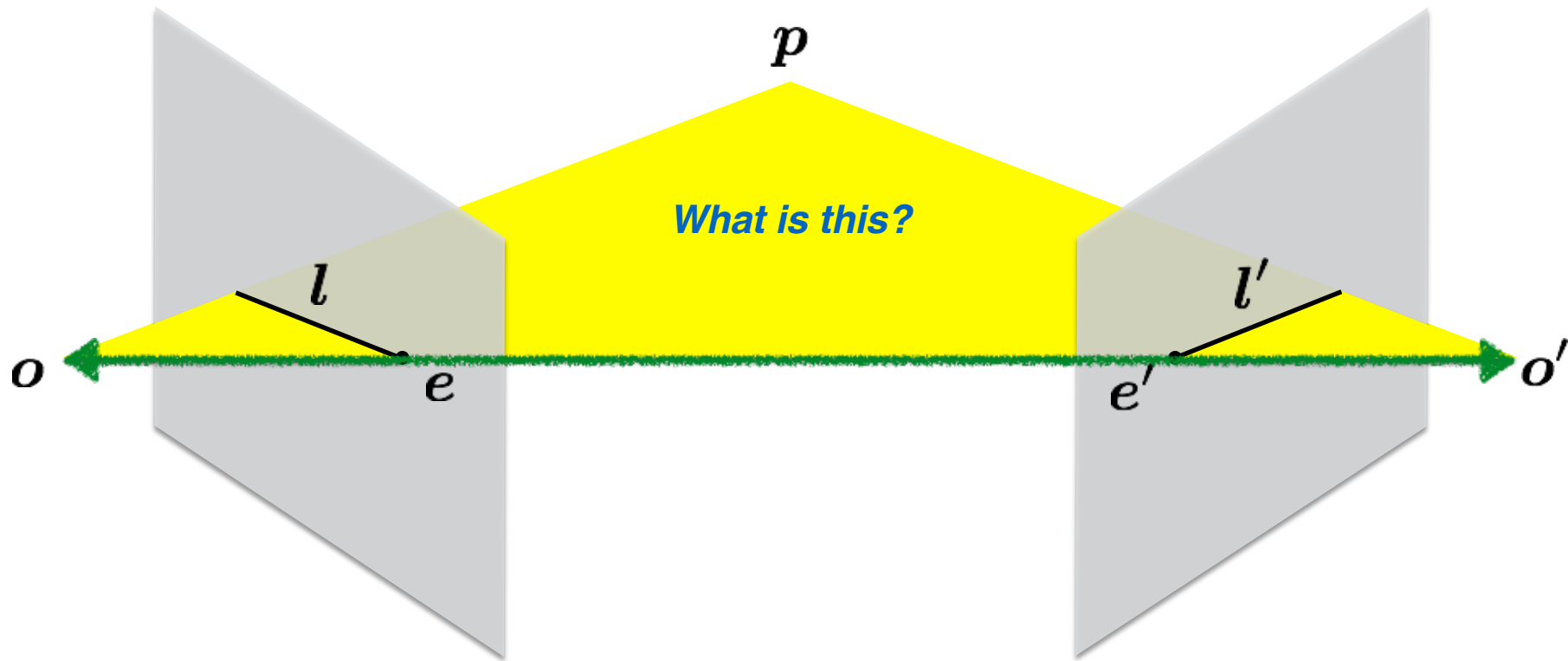

Quiz

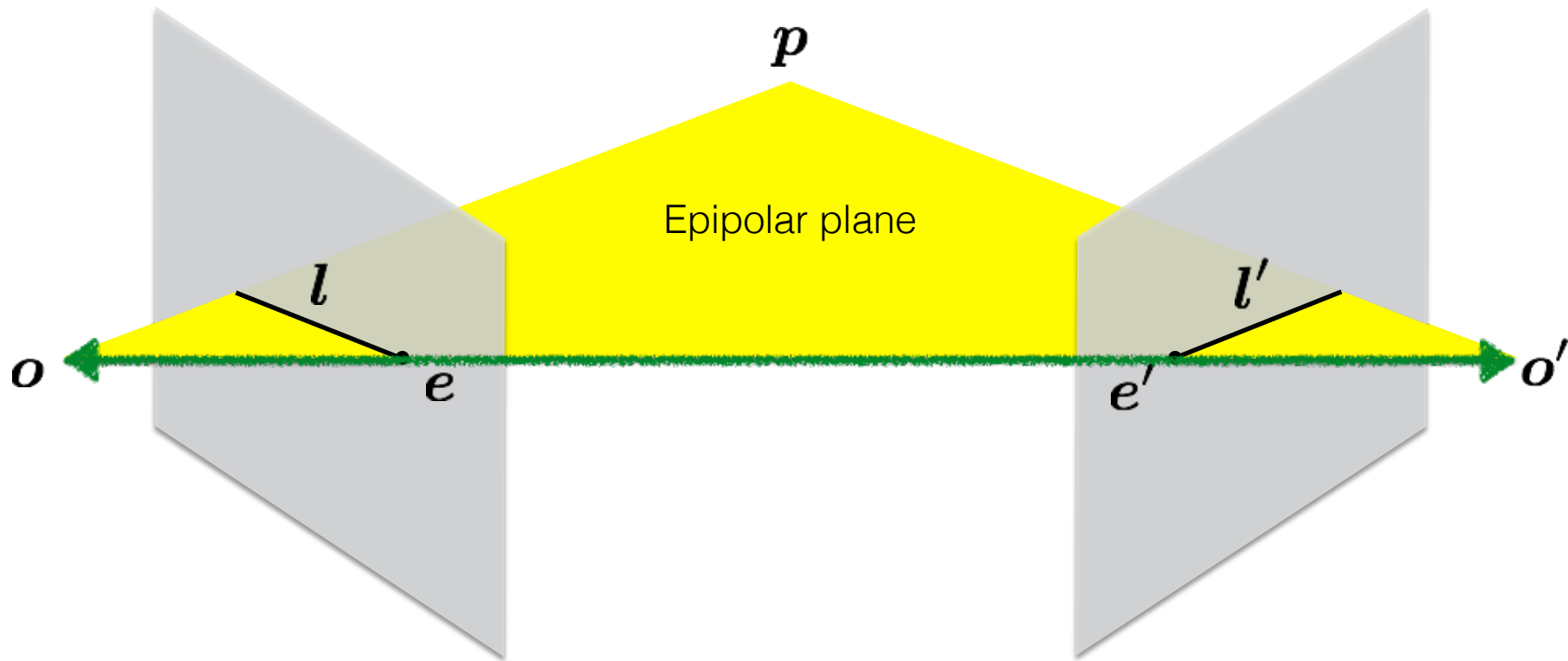

Quiz

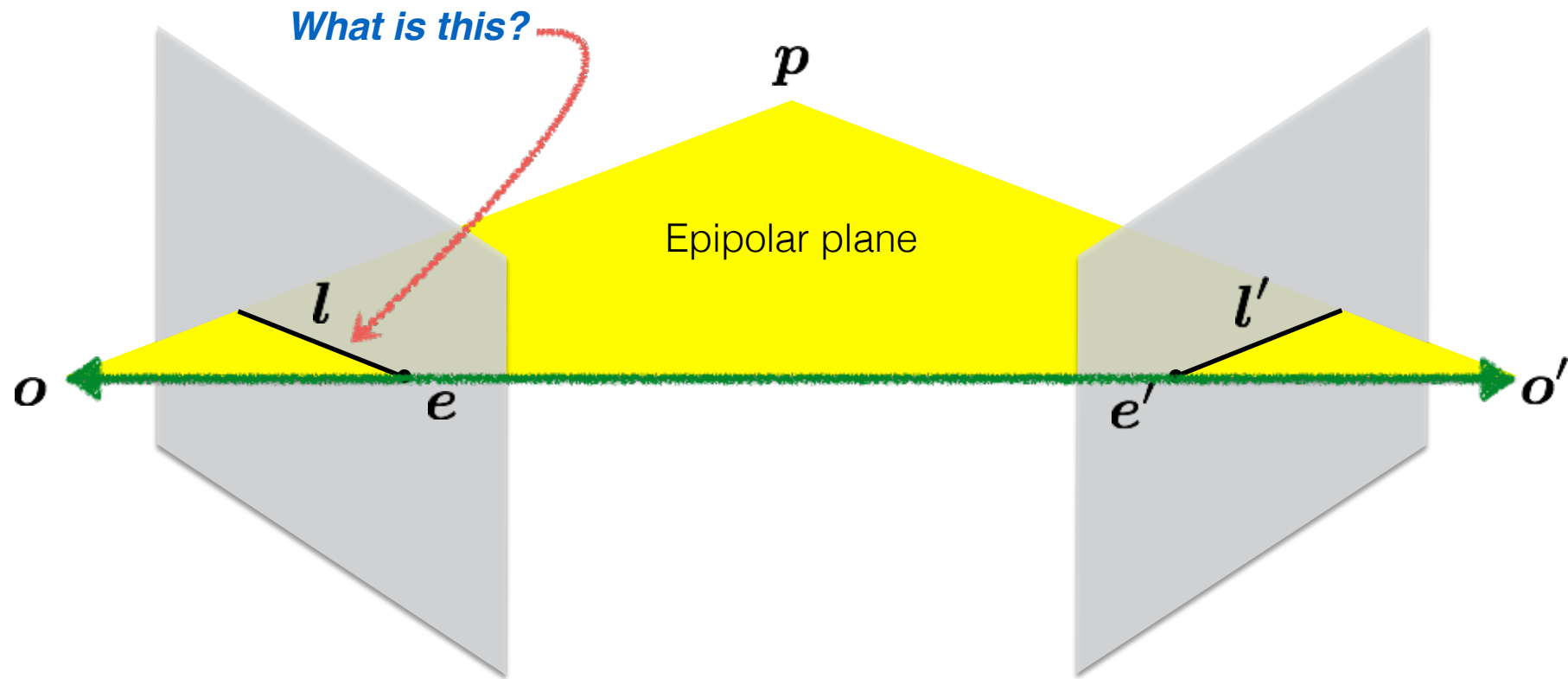

Quiz

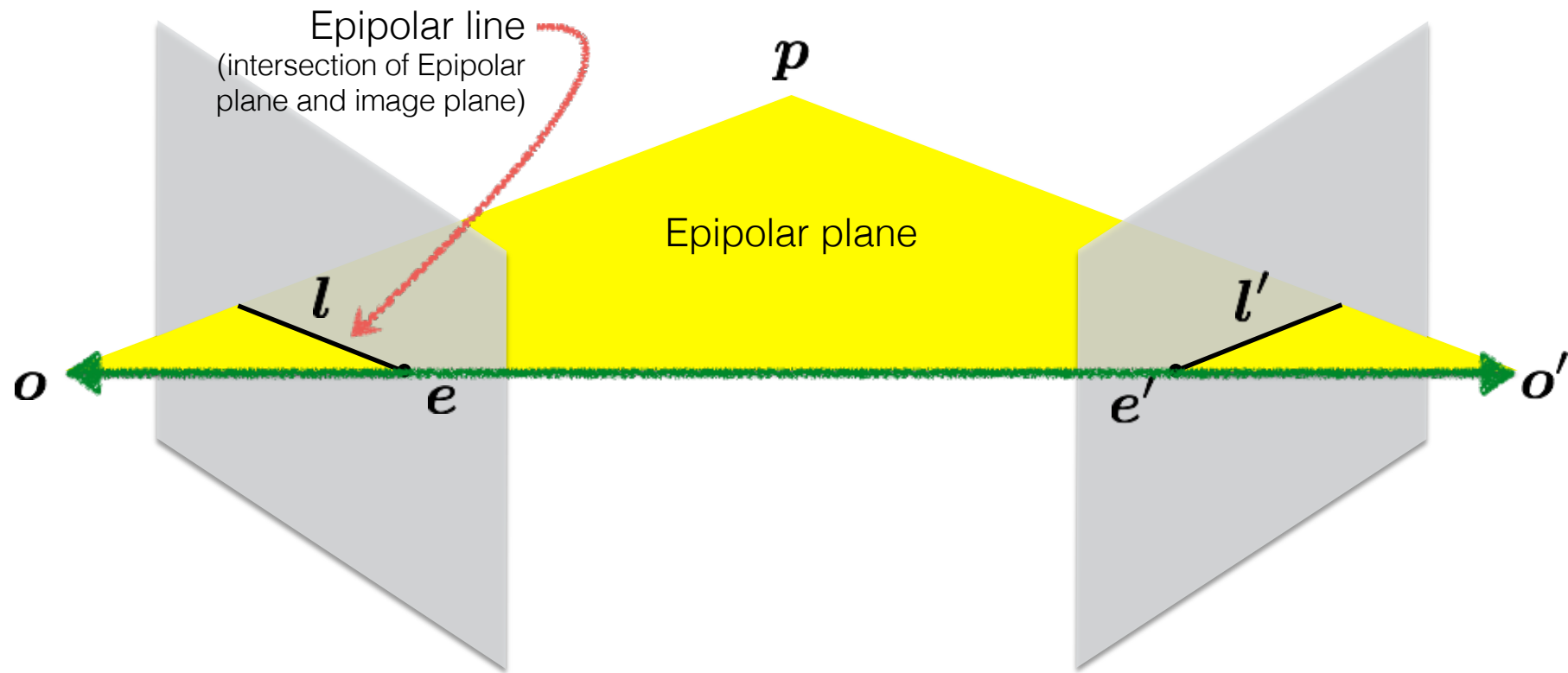

Quiz

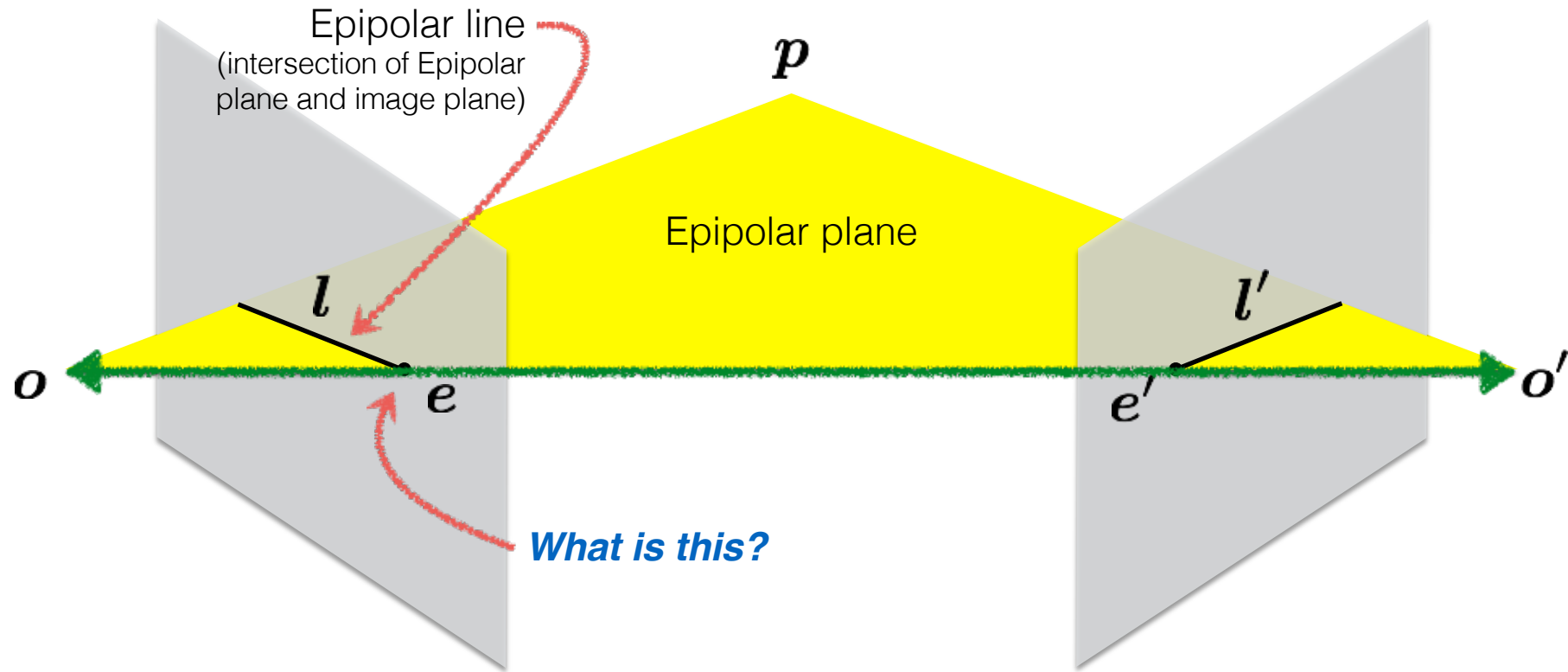

Quiz

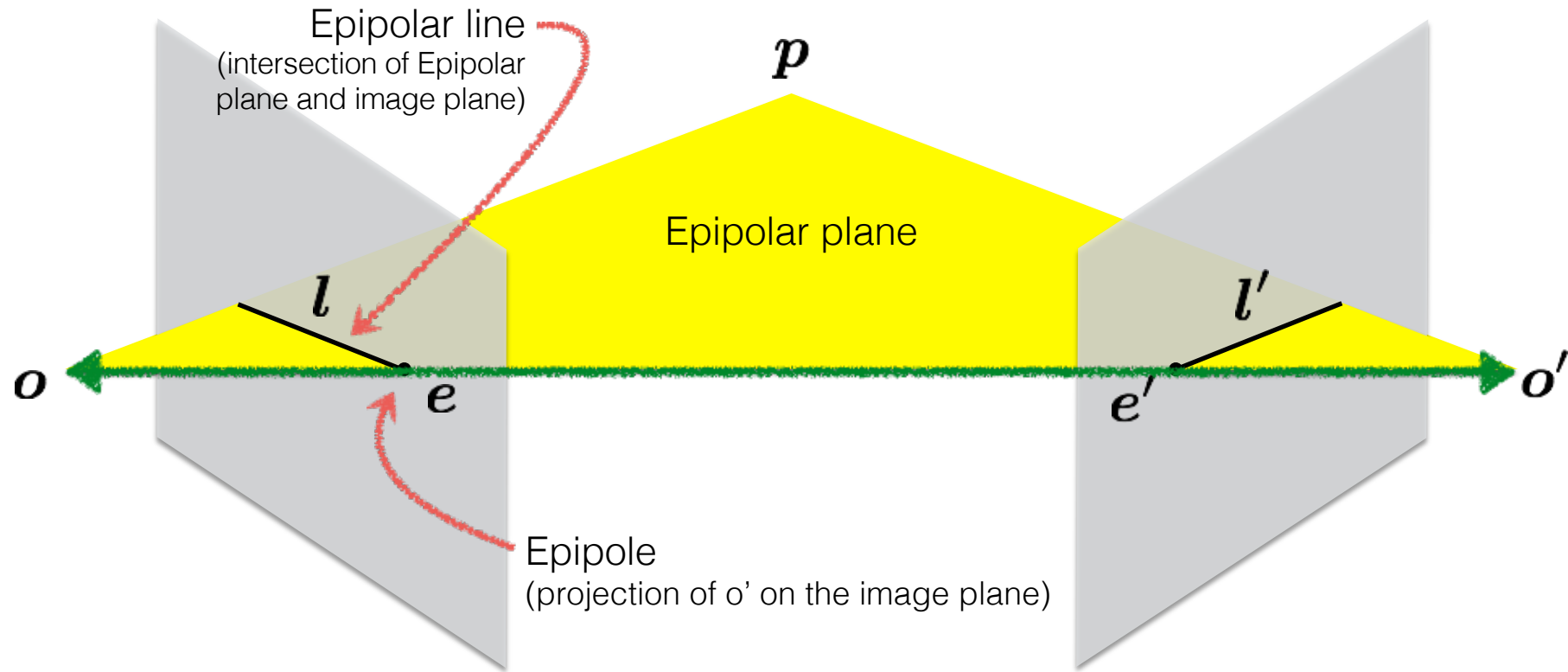

Quiz

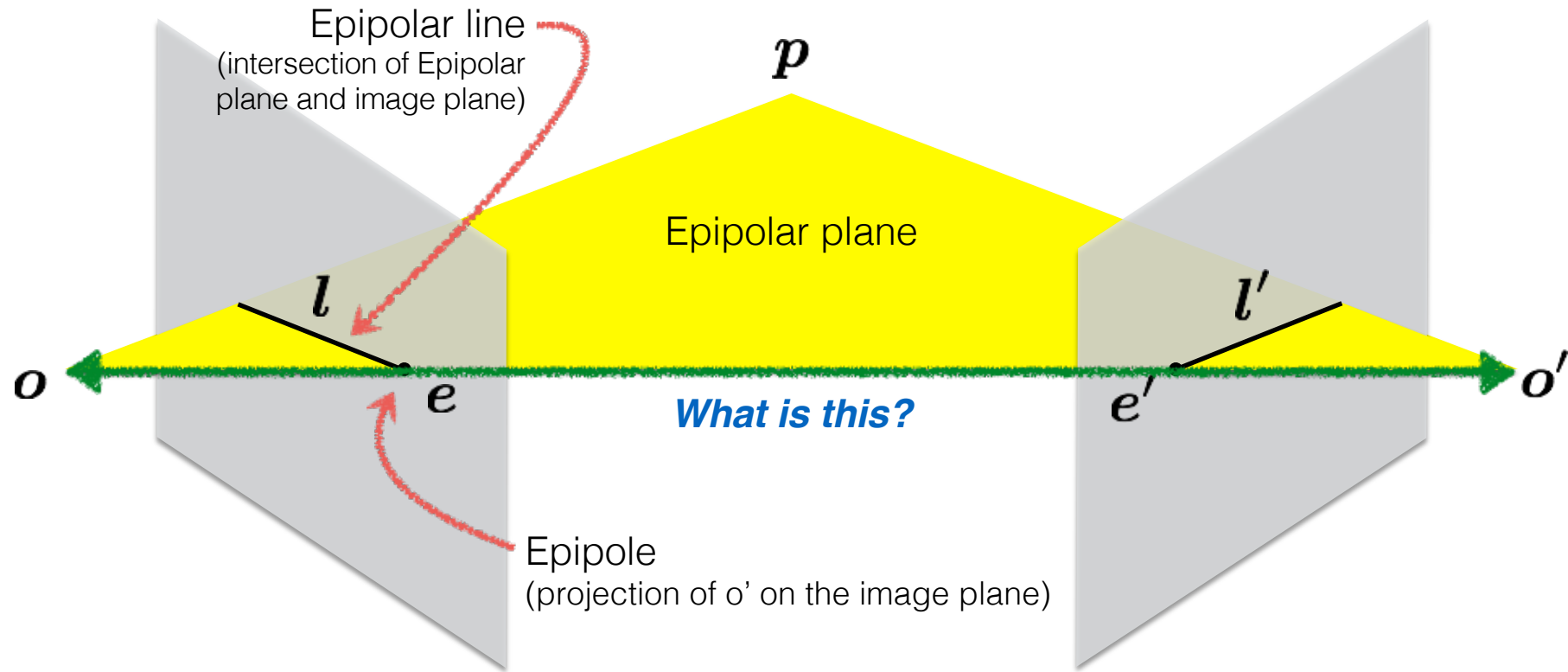

Quiz

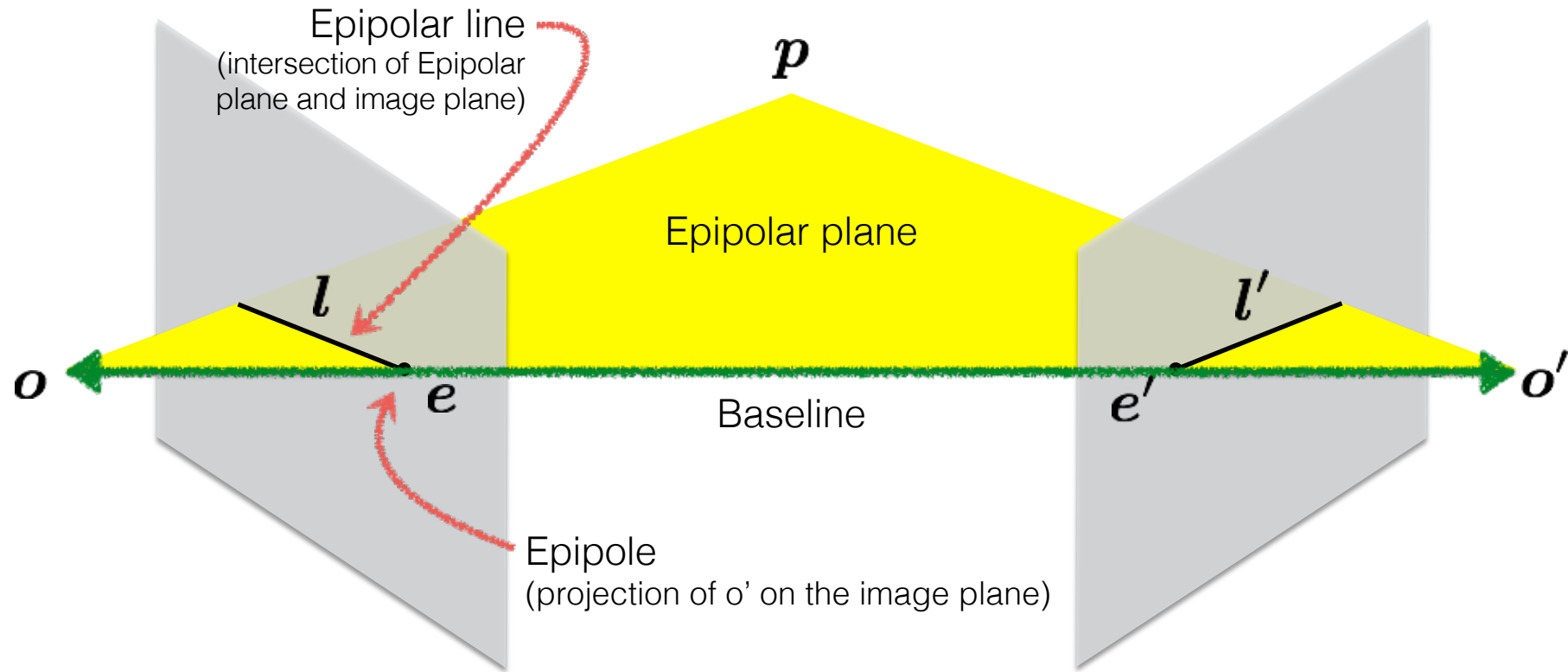

Epipolar constraint

Backproject \boldsymbol{x} to a ray in 3D

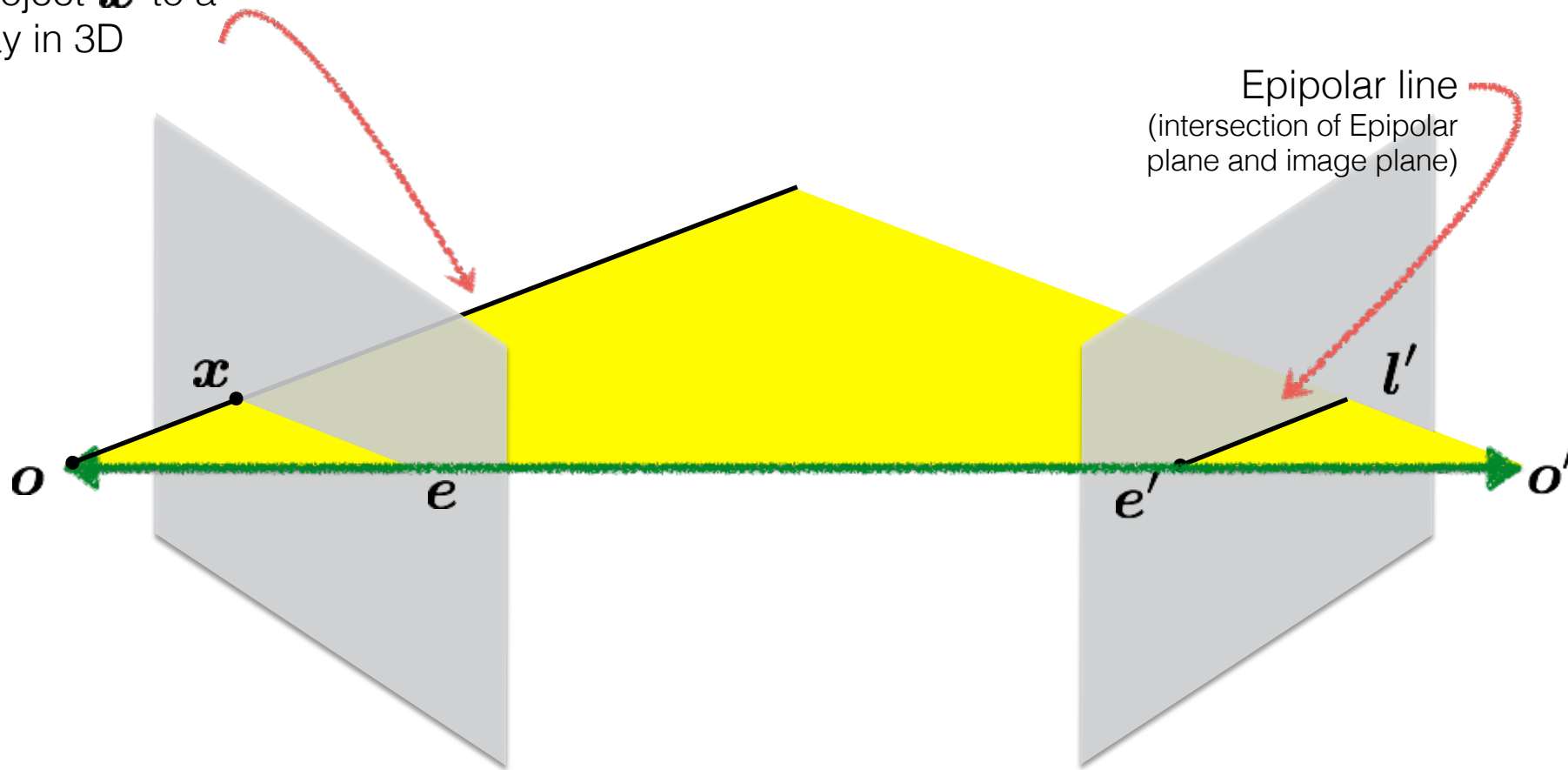

Another way to construct the epipolar plane, this time given \boldsymbol{x}

Epipolar constraint

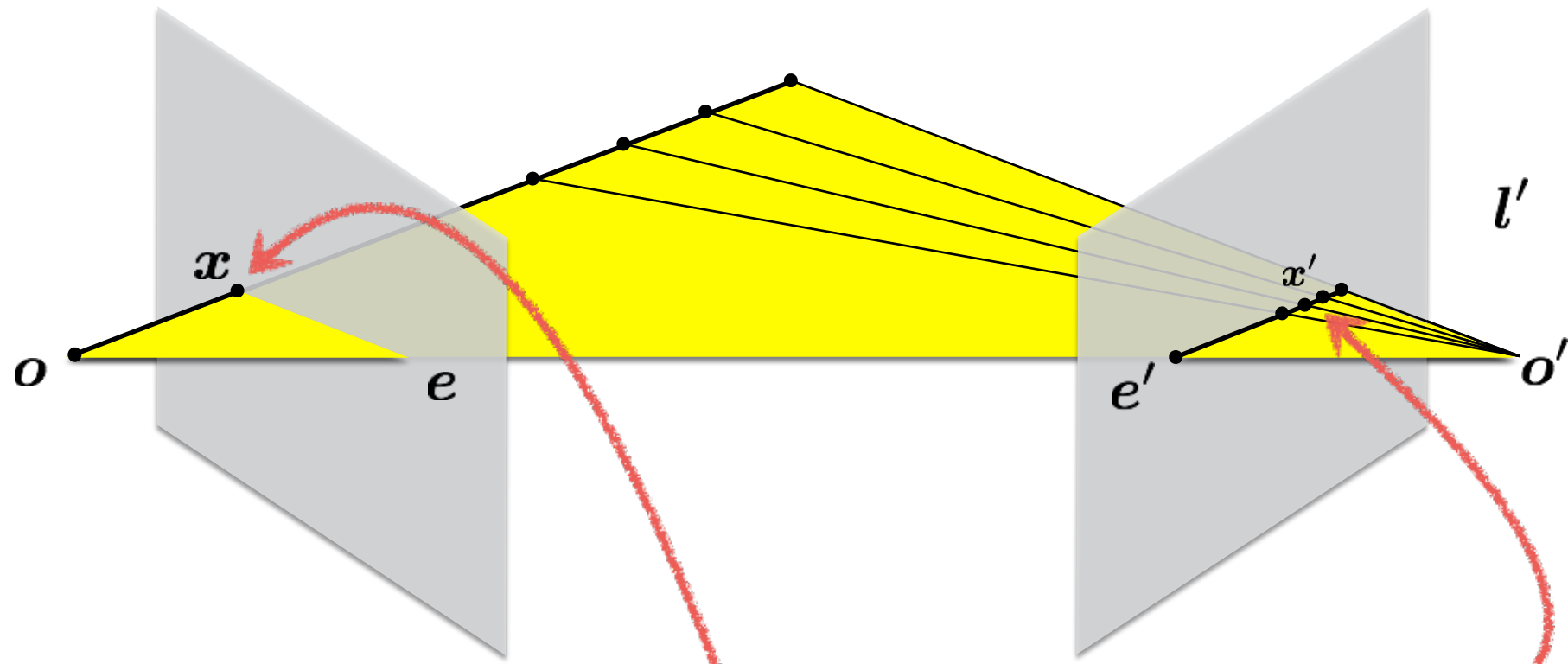

Potential matches for x lie on the epipolar line l'

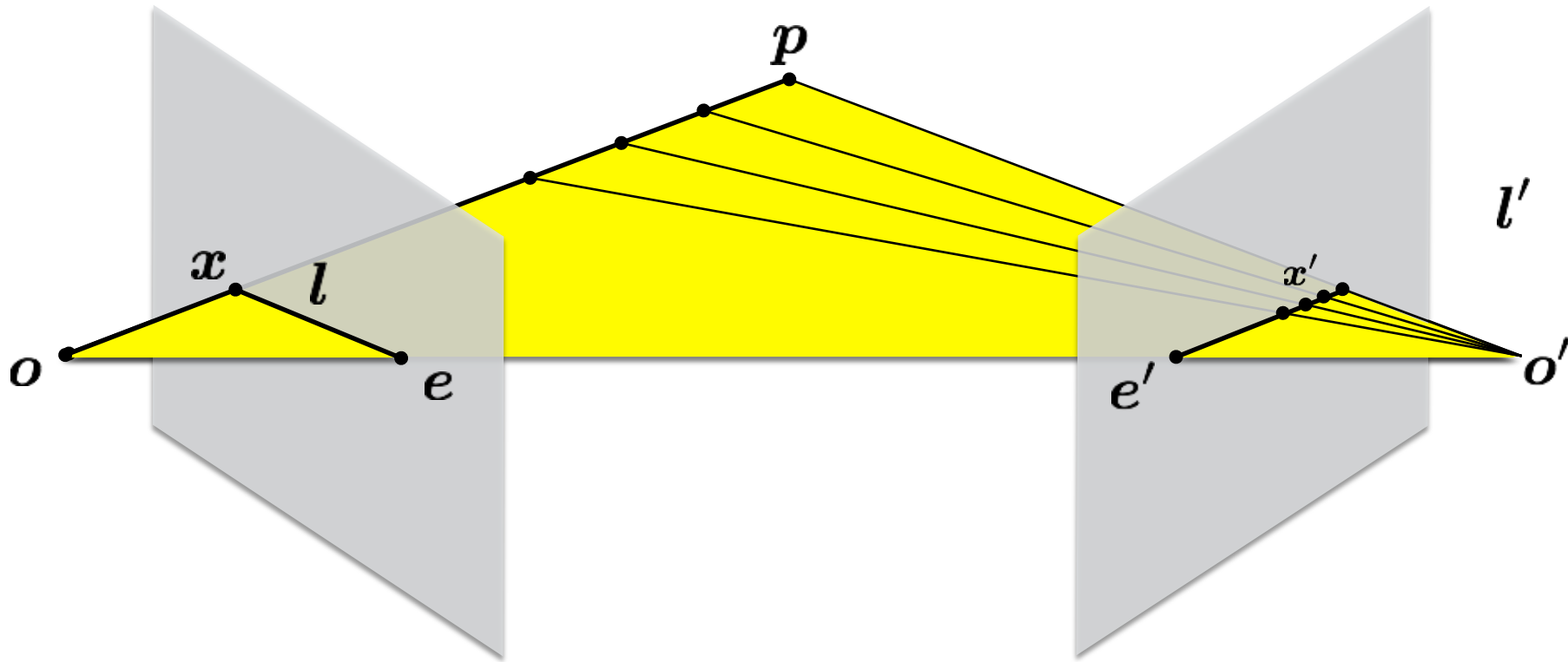

The point \mathbf{x} (left image) maps to a _____ in the right image

The baseline connects the _____ and _____

An epipolar line (left image) maps to a _____ in the right image

An epipole \mathbf{e} is a projection of the _____ on the image plane

All epipolar lines in an image intersect at the _____

Converging cameras

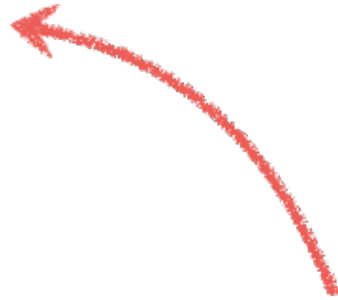
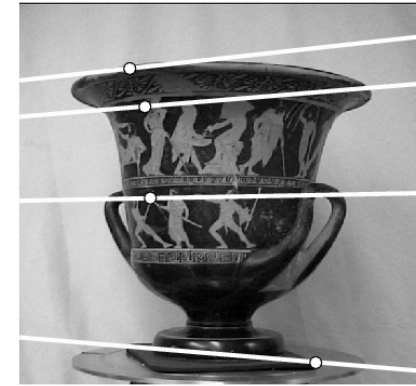
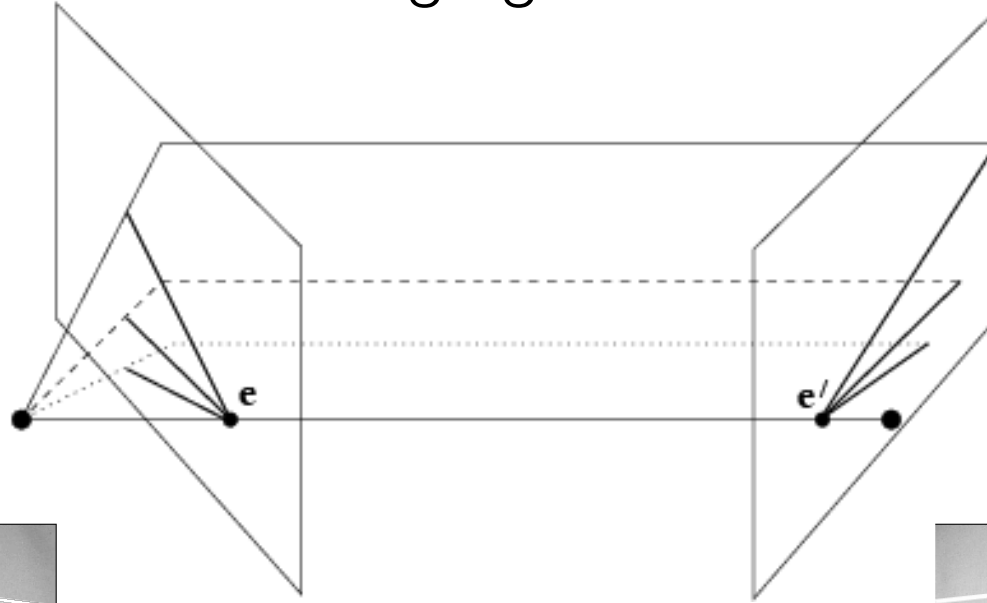

Where is the epipole in this image?

Converging cameras

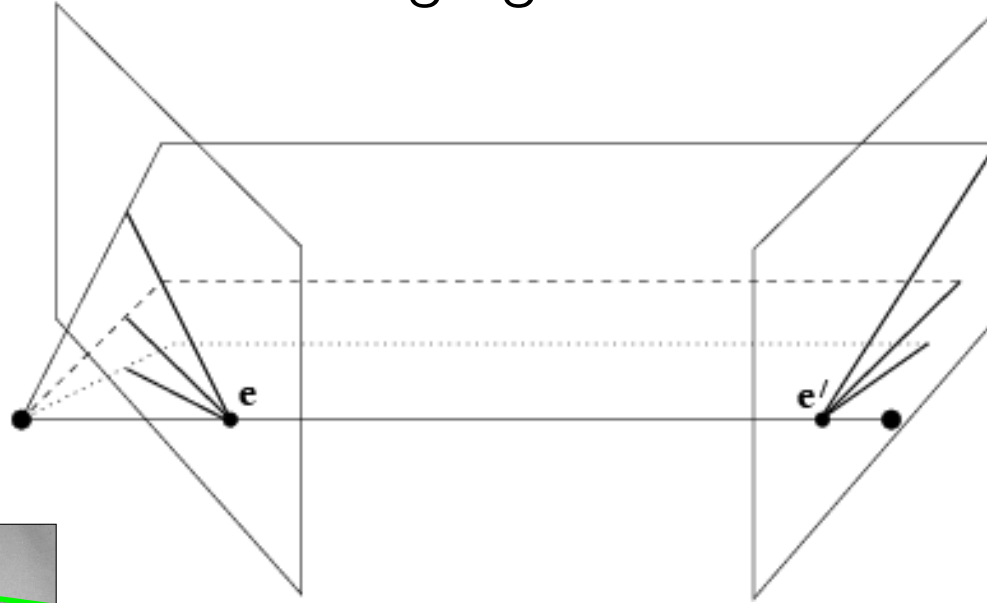

here!

Where is the epipole in this image?

It's not always in the image

Parallel cameras

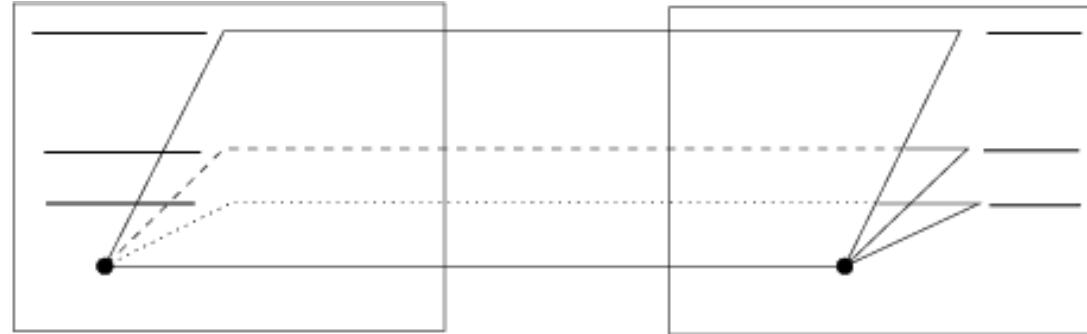

Where is the epipole?

Parallel cameras

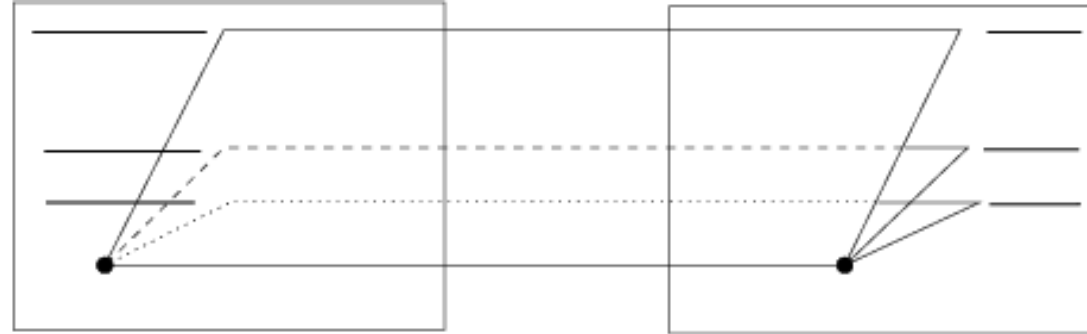

epipole at infinity

The epipolar constraint is an important concept for stereo vision

Task: Match point in left image to point in right image

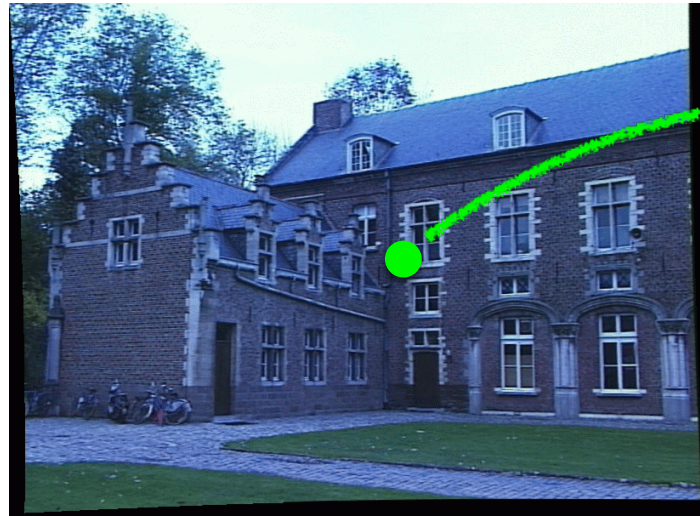

Left image

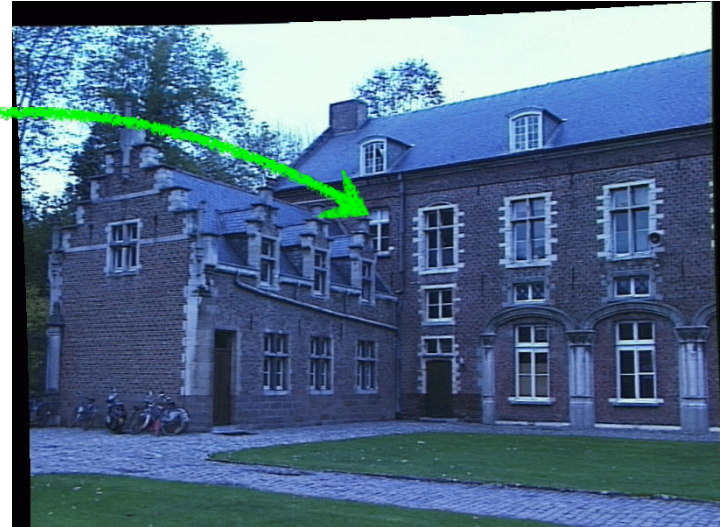

Right image

How would you do it?

Epipolar constraint

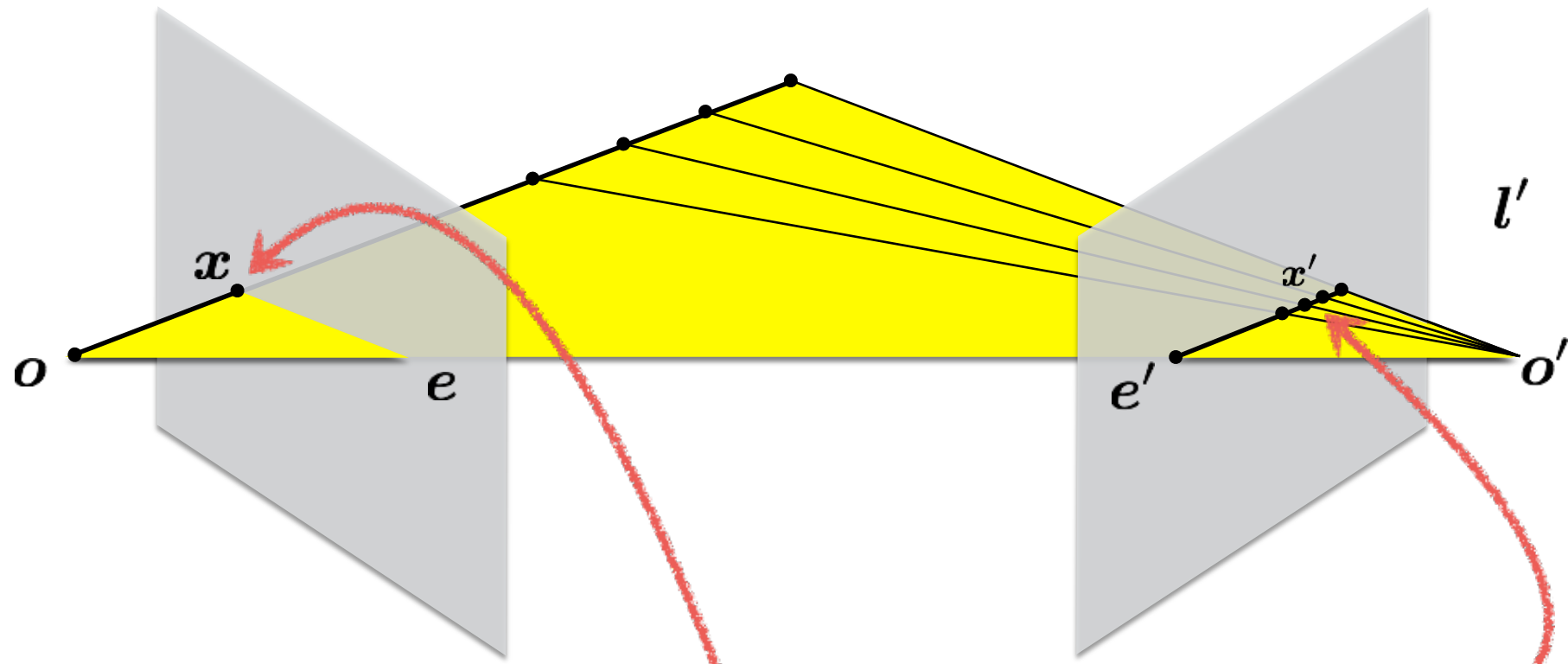

Potential matches for x lie on the epipolar line l'

The epipolar constraint is an important concept for stereo vision

Task: Match point in left image to point in right image

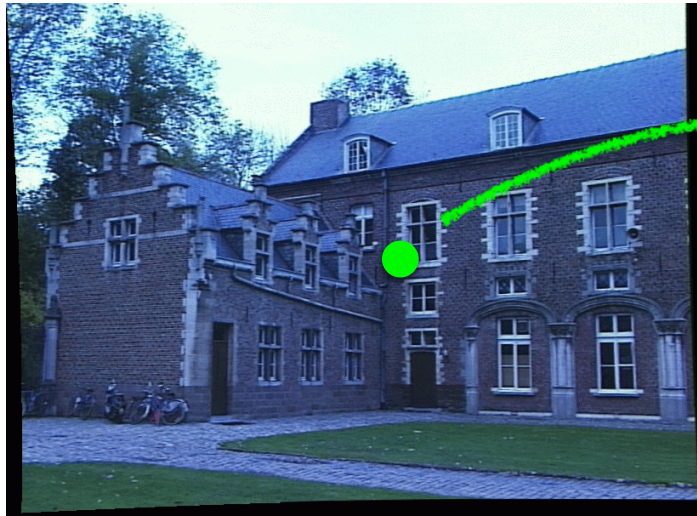

Left image

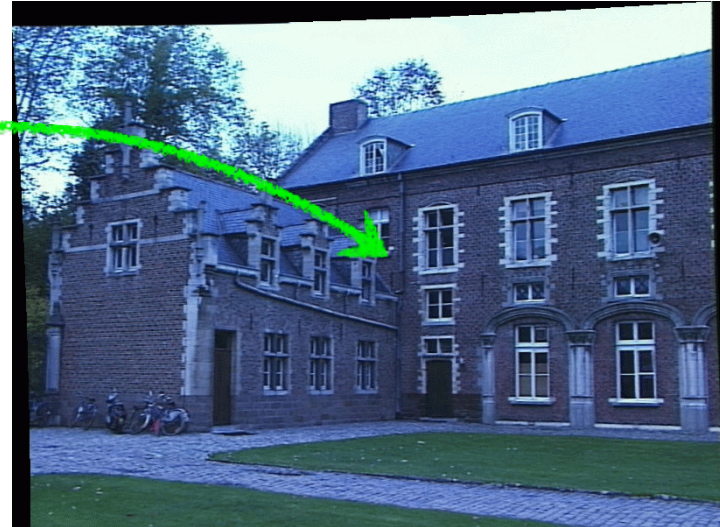

Right image

Want to avoid search over entire image

Epipolar constraint reduces search to a single line

The epipolar constraint is an important concept for stereo vision

Task: Match point in left image to point in right image

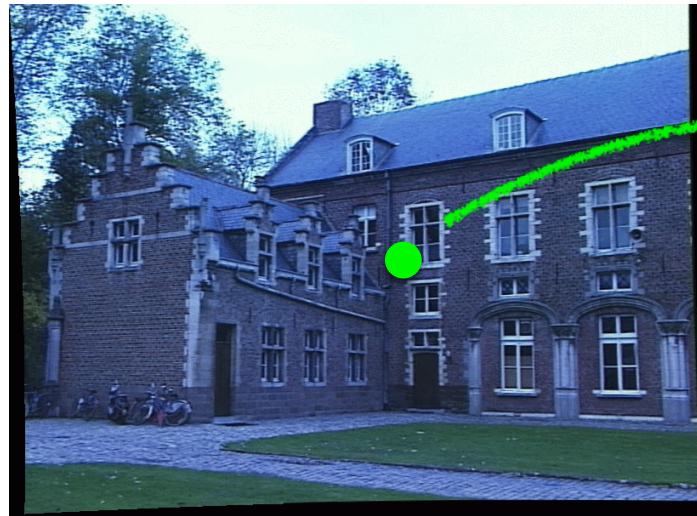

Left image

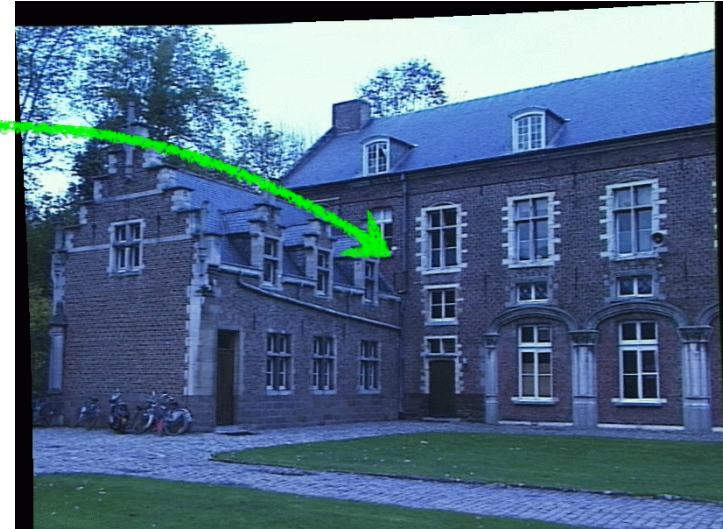

Right image

Want to avoid search over entire image

Epipolar constraint reduces search to a single line

How do you compute the epipolar line?

The essential matrix

Recall: Epipolar constraint

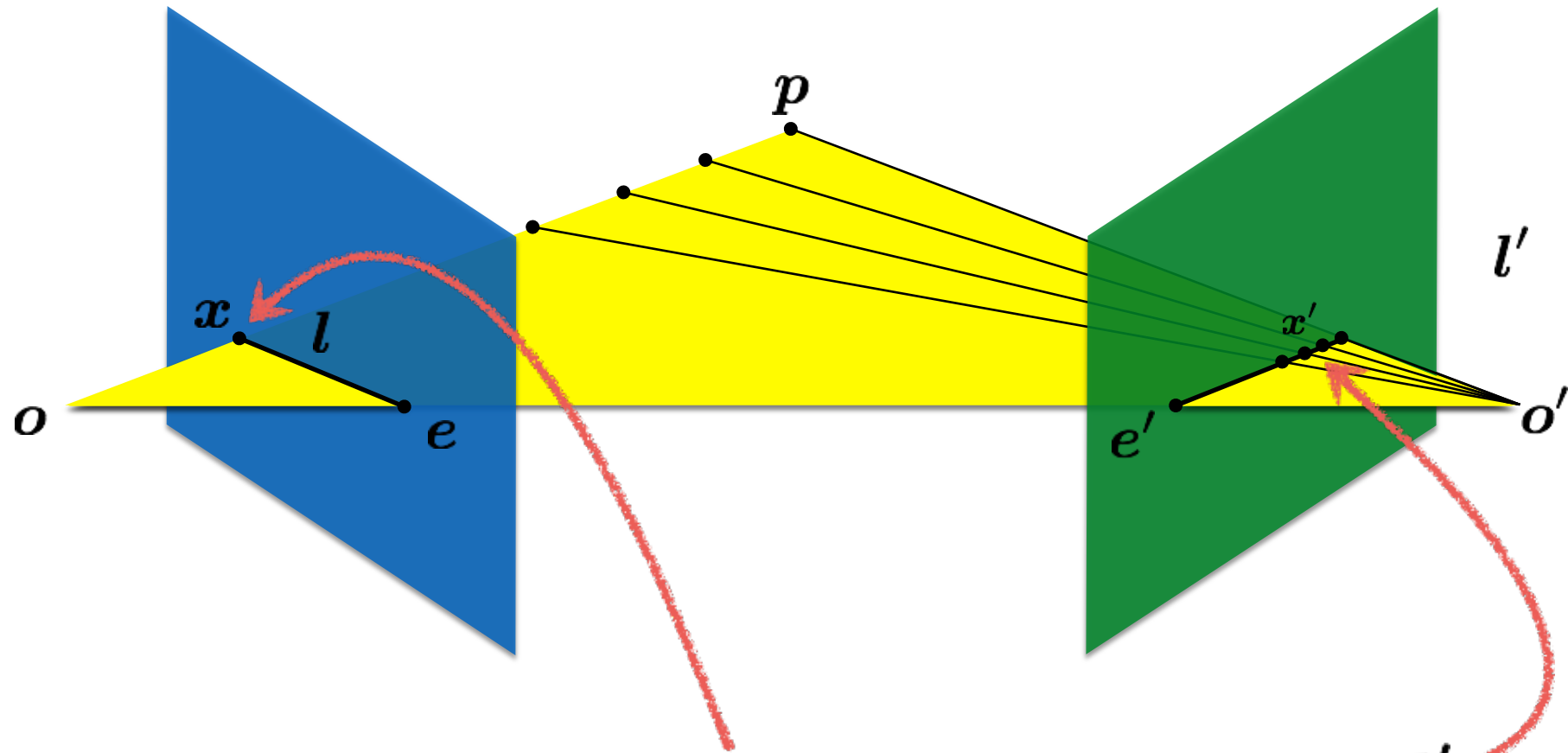

Potential matches for x lie on the epipolar line l'

Given a point in one image, multiplying by the **essential matrix** will tell us the **epipolar line** in the second view.

$$Ex = l'$$

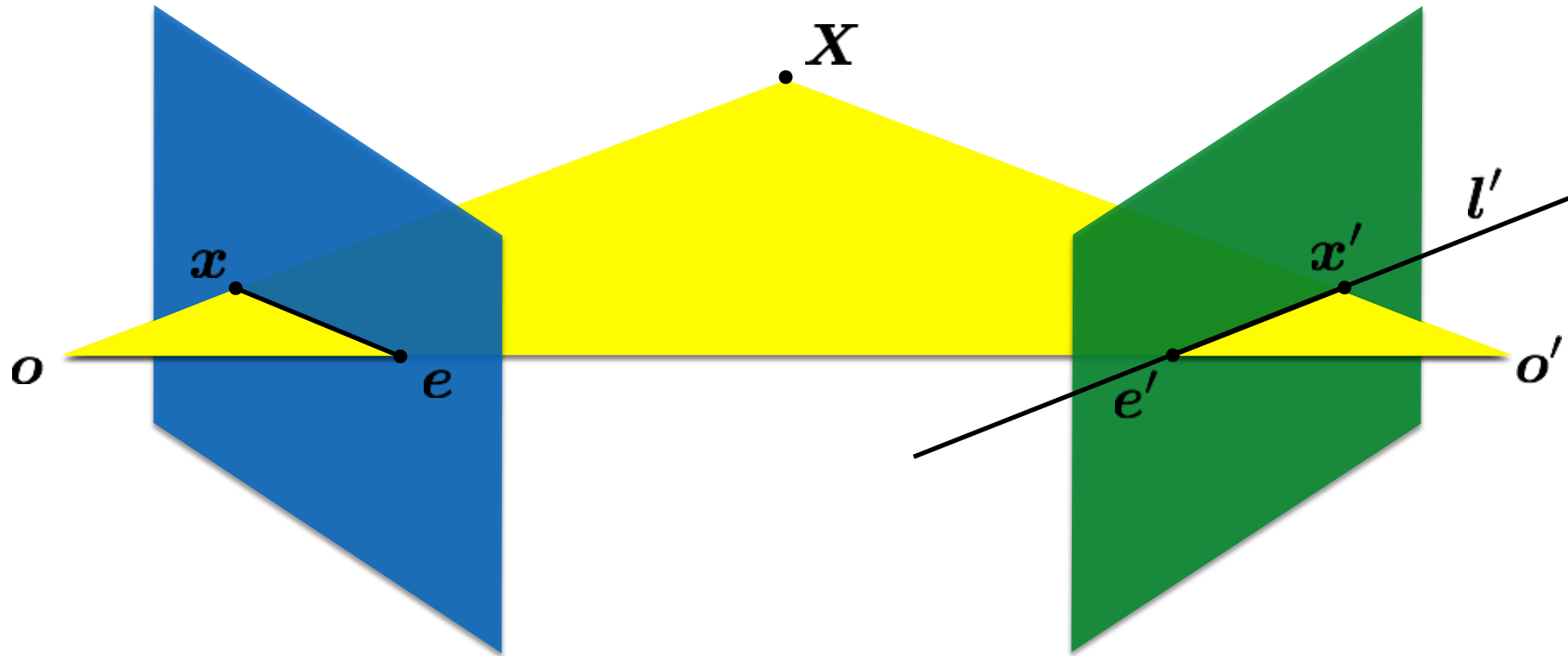

Motivation

The Essential Matrix is a 3×3 matrix that encodes **epipolar geometry**

Given a point in one image, multiplying by the **essential matrix** will tell us the **epipolar line** in the second image.

Epipolar Line

$$ax + by + c = 0 \quad \text{in vector form} \quad \mathbf{l} = \begin{bmatrix} a \\ b \\ c \end{bmatrix}$$

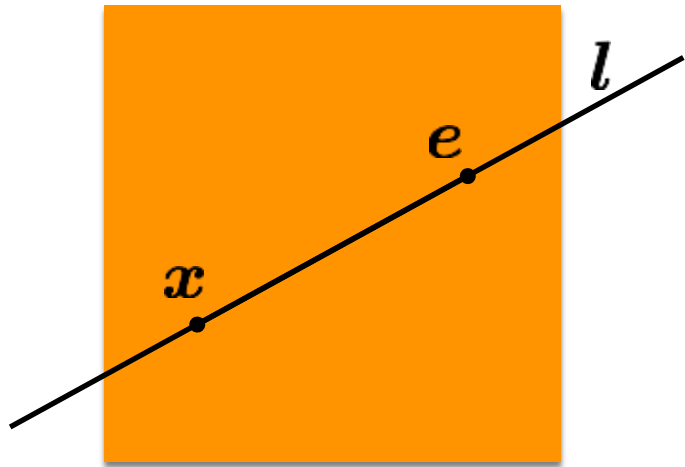

If the point \mathbf{x} is on the epipolar line \mathbf{l} then

$$\mathbf{x}^\top \mathbf{l} = ?$$

Epipolar Line

$$ax + by + c = 0 \quad \text{in vector form} \quad \mathbf{l} = \begin{bmatrix} a \\ b \\ c \end{bmatrix}$$

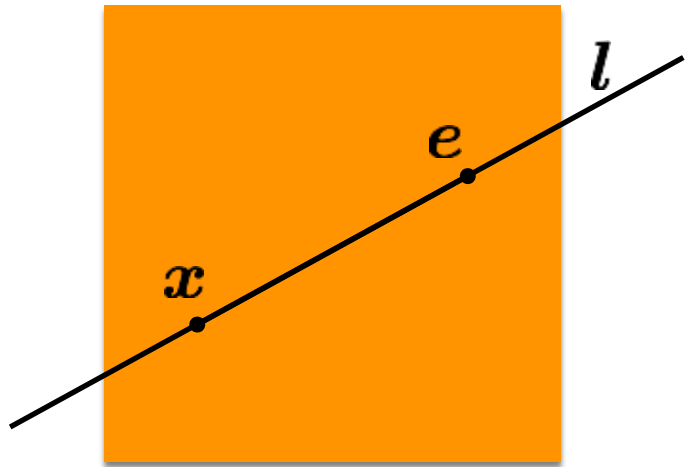

If the point \mathbf{x} is on the epipolar line \mathbf{l} then

$$\mathbf{x}^\top \mathbf{l} = 0$$

So if $\mathbf{x}'^\top \mathbf{l}' = 0$ and $\mathbf{E}\mathbf{x} = \mathbf{l}'$ then

$$\mathbf{x}'^\top \mathbf{E}\mathbf{x} = ?$$

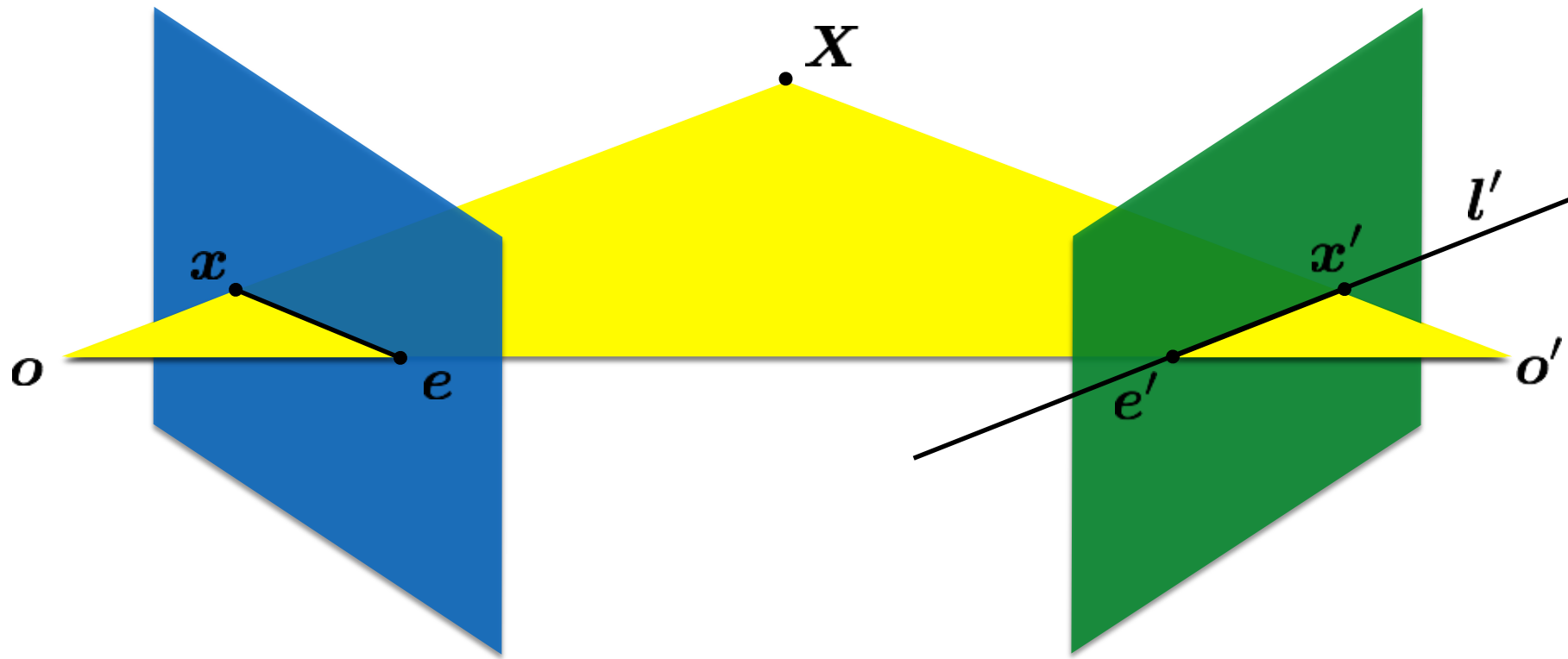

So if $\mathbf{x}'^\top \mathbf{l}' = 0$ and $\mathbf{E}\mathbf{x} = \mathbf{l}'$ then

$$\mathbf{x}'^\top \mathbf{E}\mathbf{x} = 0$$

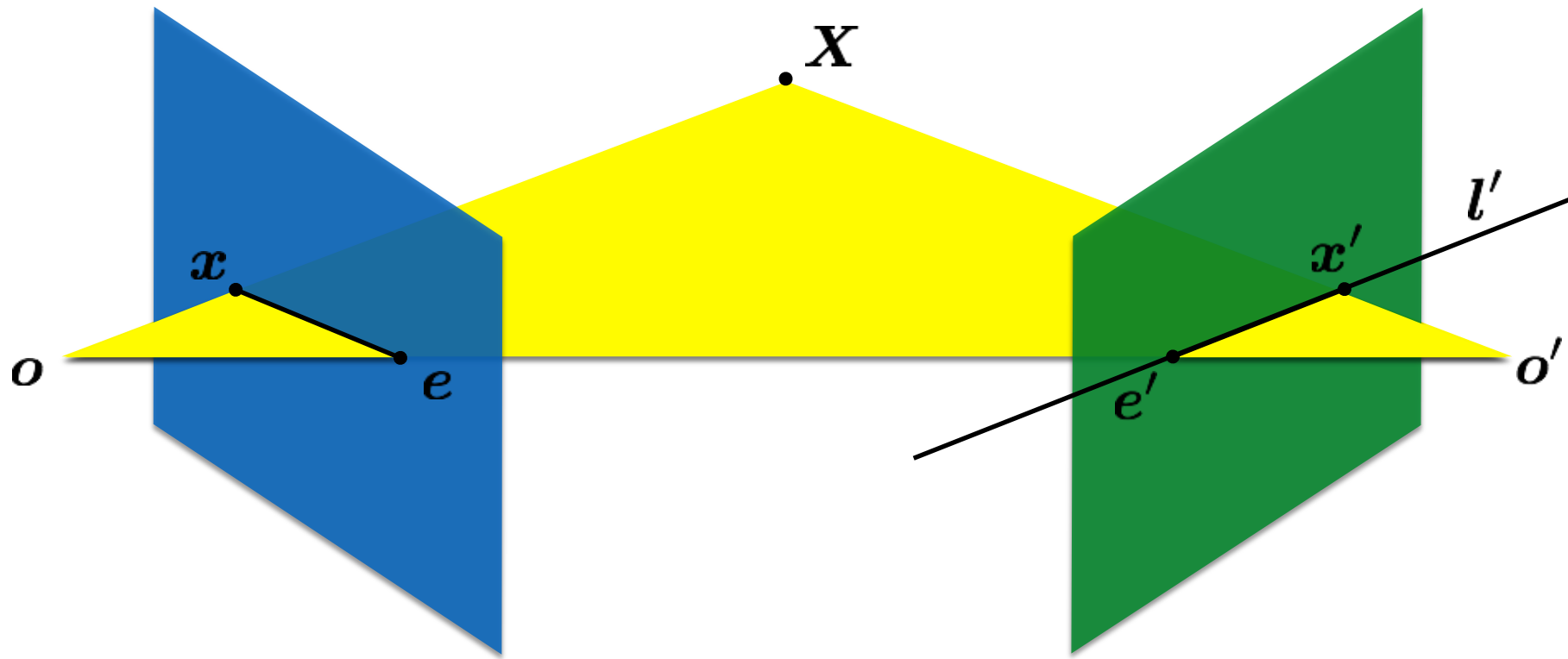

Essential Matrix vs Homography

What's the difference between the essential matrix and a homography?

Essential Matrix vs Homography

What's the difference between the essential matrix and a homography?

They are both 3 x 3 matrices but ...

$$l' = \mathbf{E}x$$

Essential matrix maps a
point to a **line**

$$x' = \mathbf{H}x$$

Homography maps a
point to a **point**

Where does the essential matrix come from?

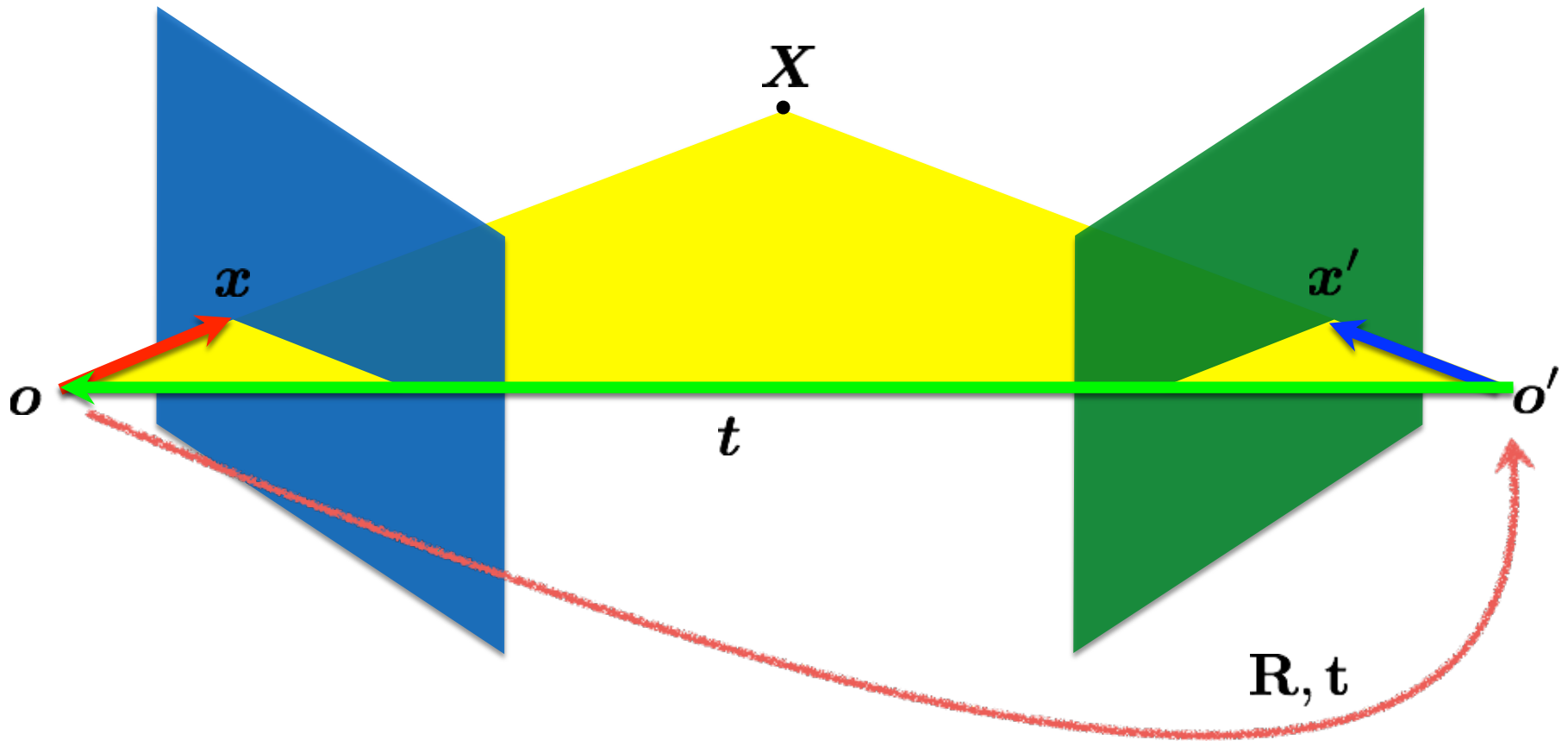

$$x' = \mathbf{R}(x - t)$$

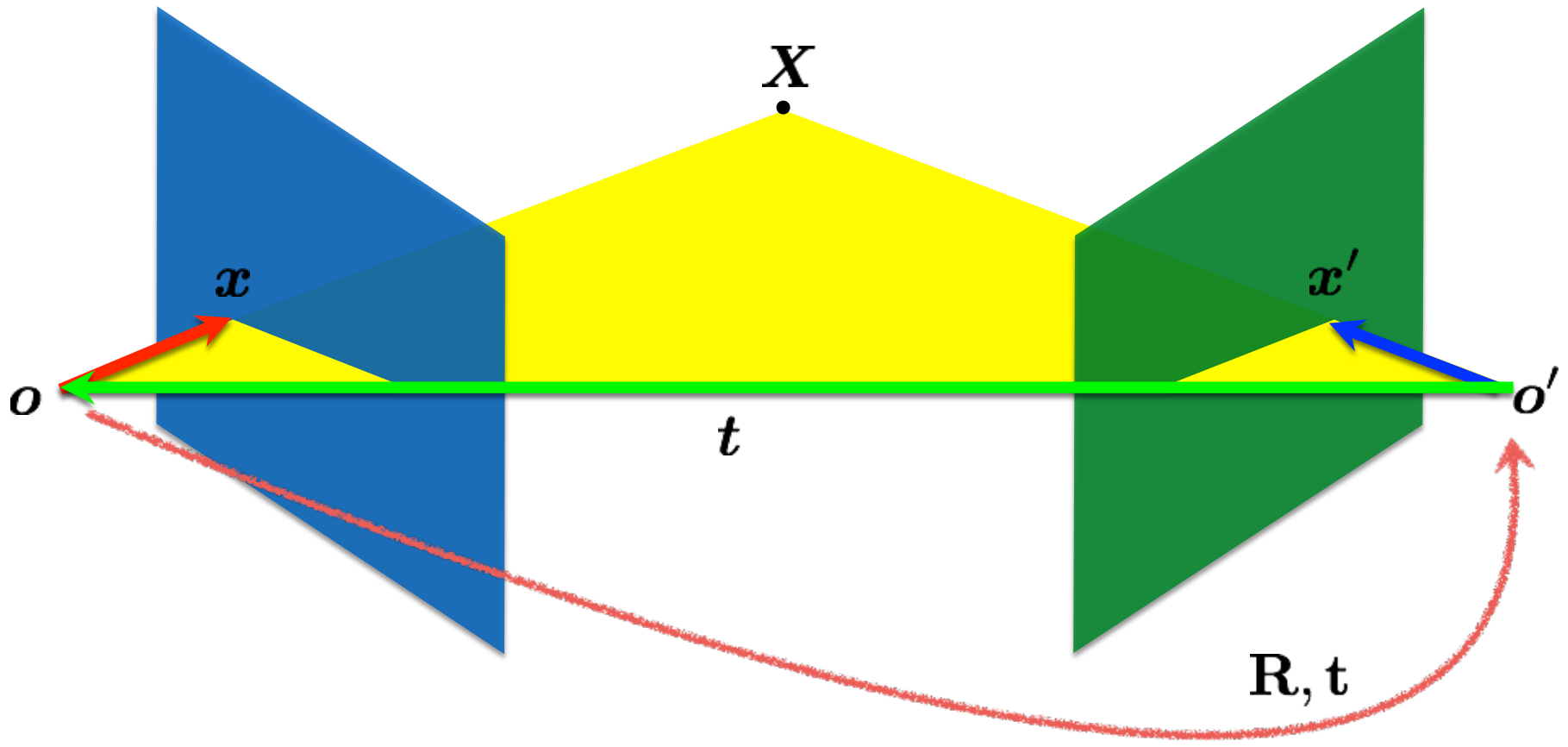

$$\mathbf{x}' = \mathbf{R}(\mathbf{x} - \mathbf{t})$$

Does this look familiar?

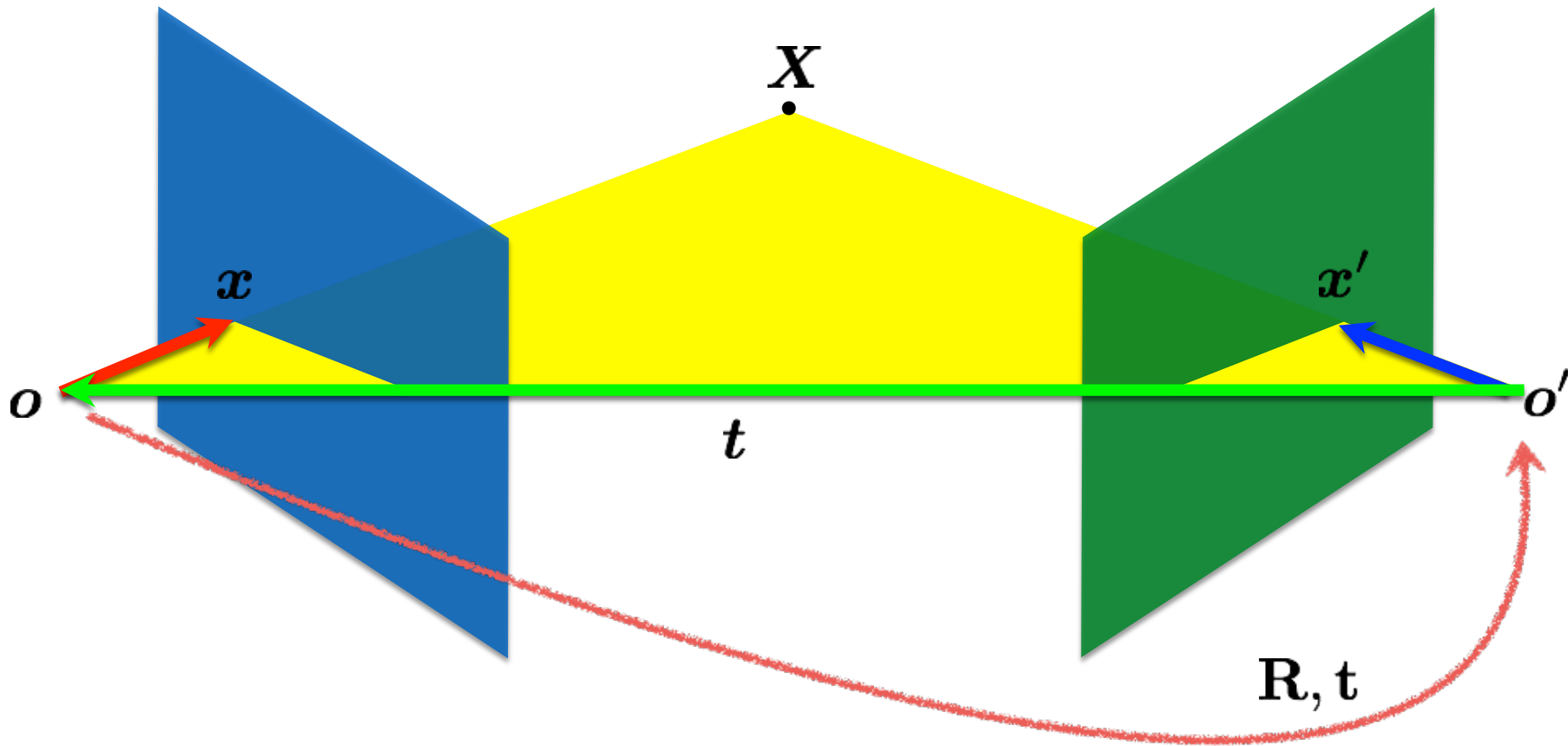

$$x' = R(x - t)$$

Camera-camera transform just like **world-camera** transform

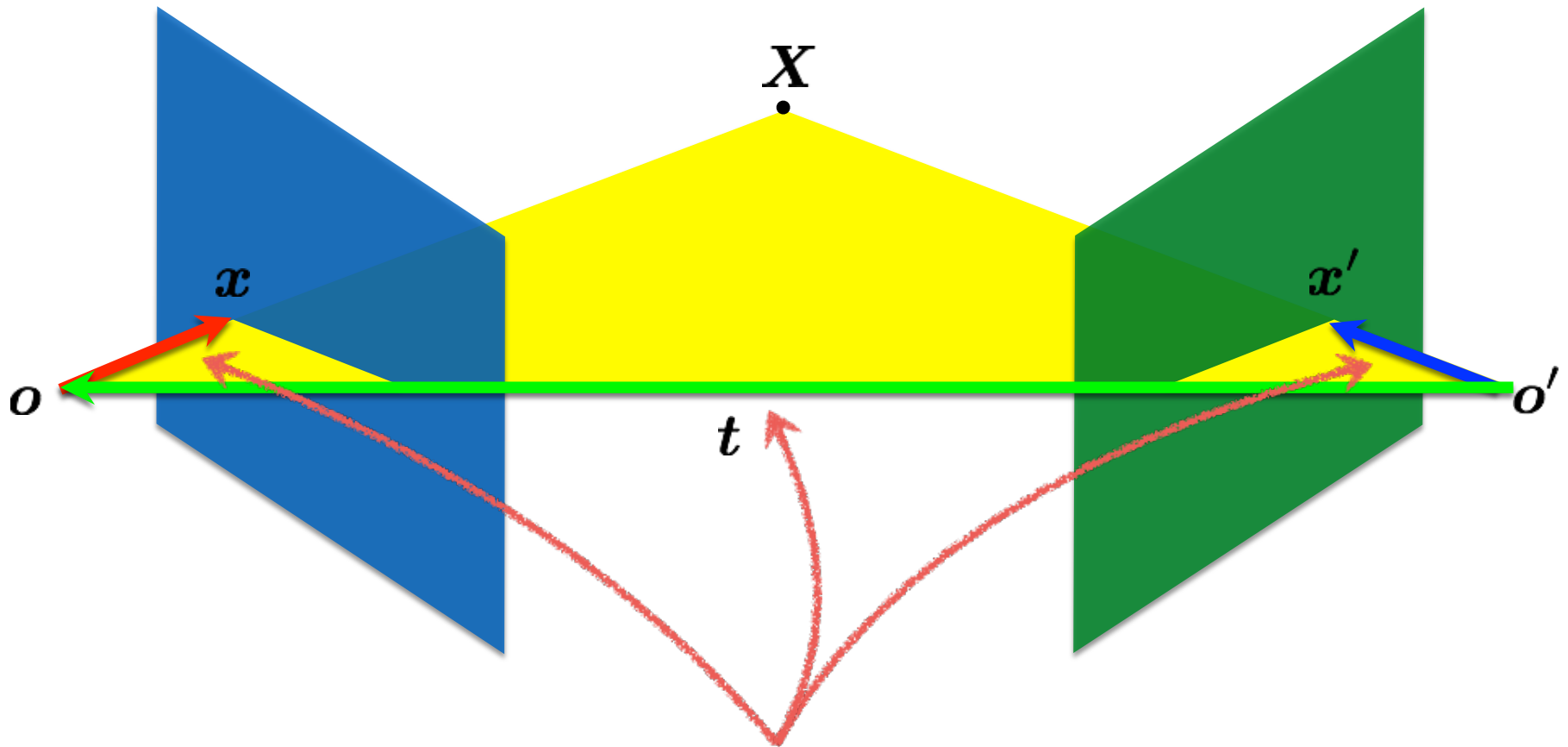

These three vectors are coplanar

$$\mathbf{x}, \mathbf{t}, \mathbf{x}'$$

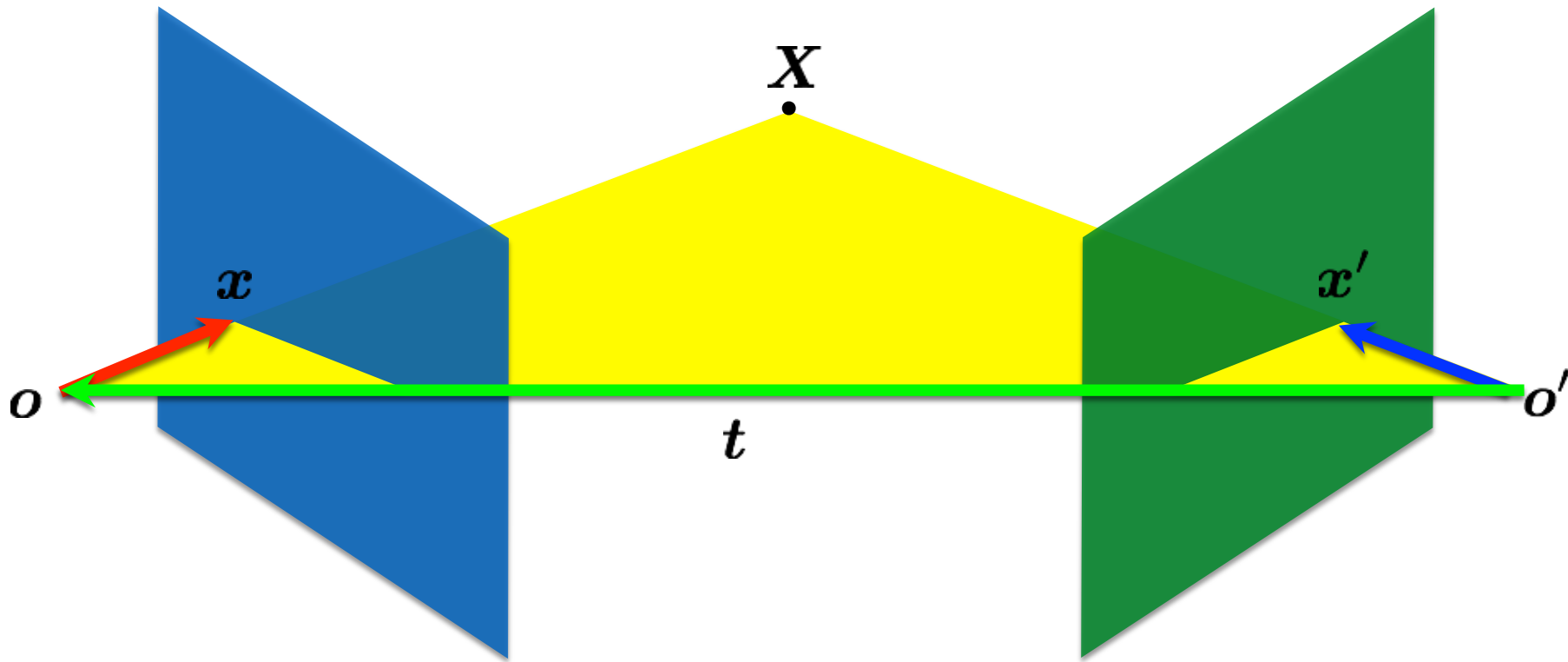

If these three vectors are coplanar $\mathbf{x}, \mathbf{t}, \mathbf{x}'$ then

$$\mathbf{x}^\top (\mathbf{t} \times \mathbf{x}) = ?$$

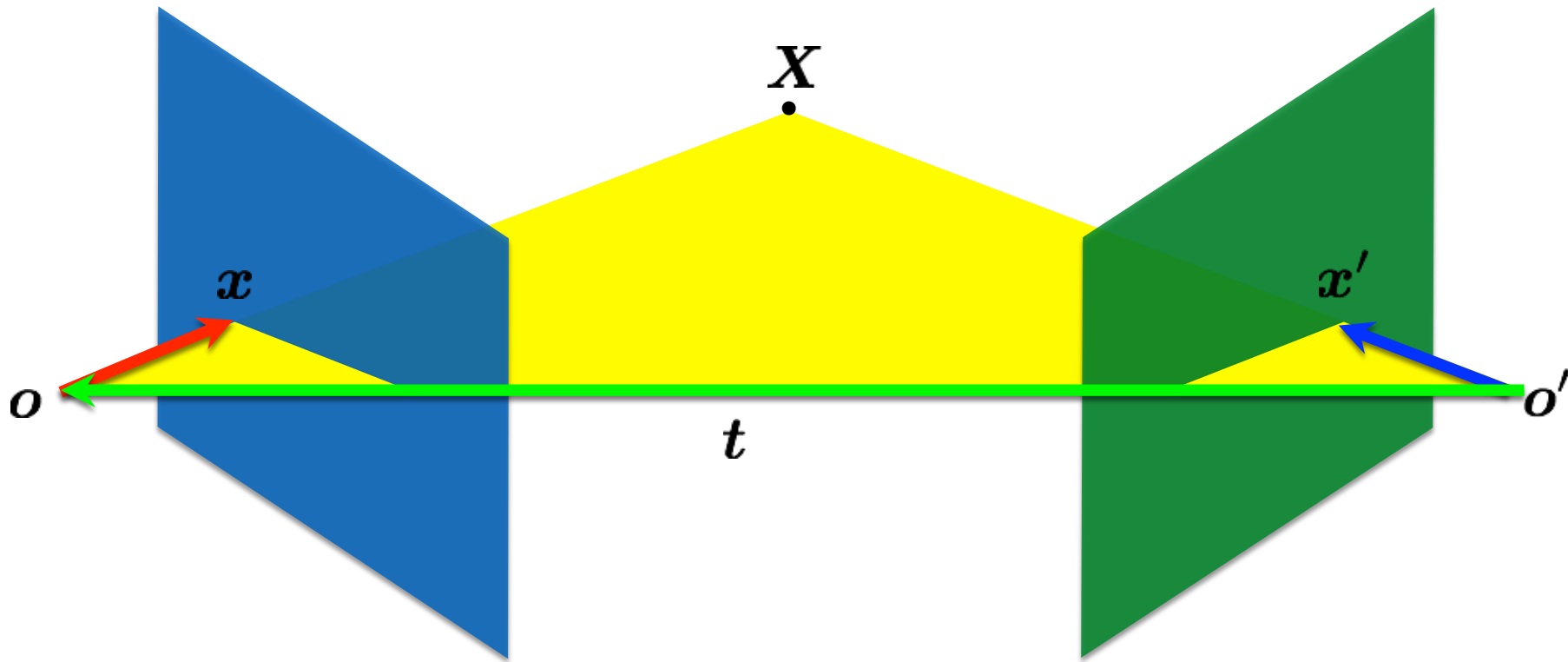

If these three vectors are coplanar $\mathbf{x}, \mathbf{t}, \mathbf{x}'$ then

$$\mathbf{x}^\top (\mathbf{t} \times \mathbf{x}) = 0$$

dot product of orthogonal vectors

cross-product: vector orthogonal to plane

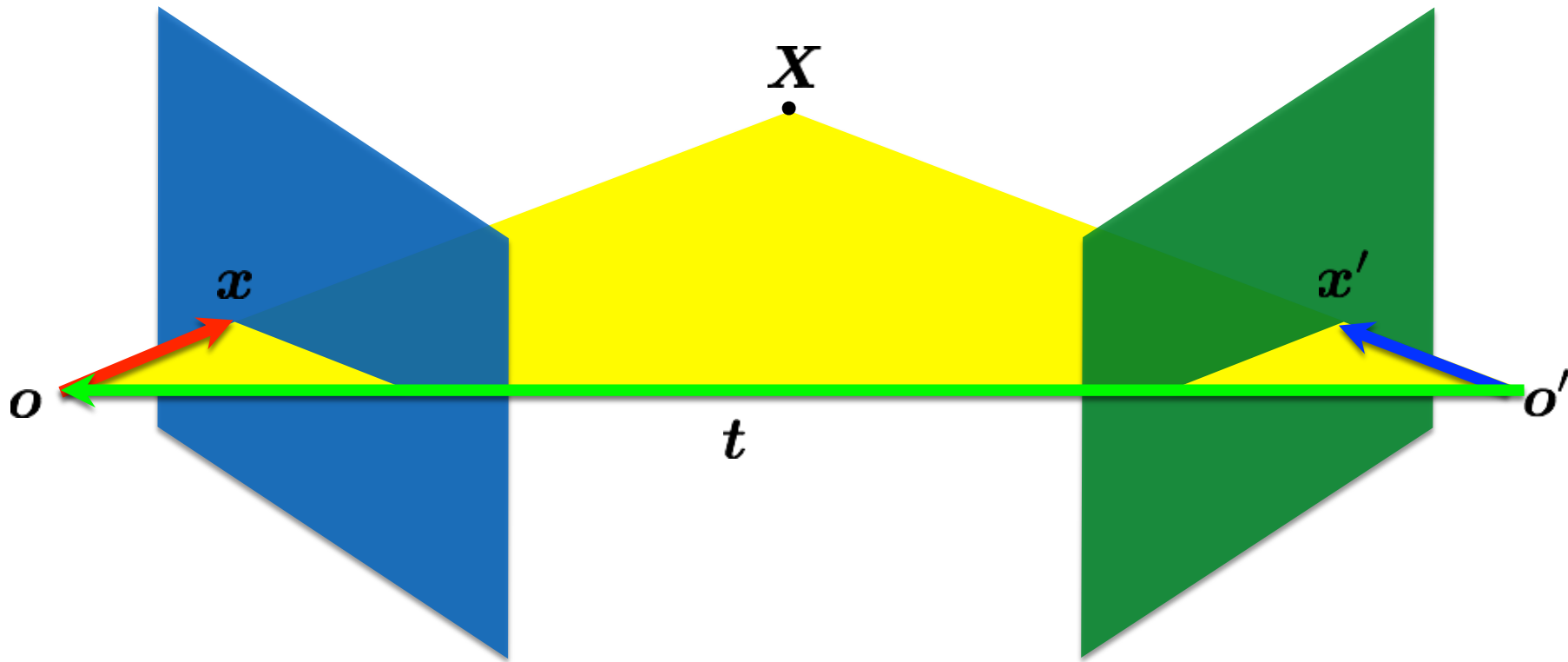

If these three vectors are coplanar $\mathbf{x}, \mathbf{t}, \mathbf{x}'$ then

$$(\mathbf{x} - \mathbf{t})^\top (\mathbf{t} \times \mathbf{x}) = ?$$

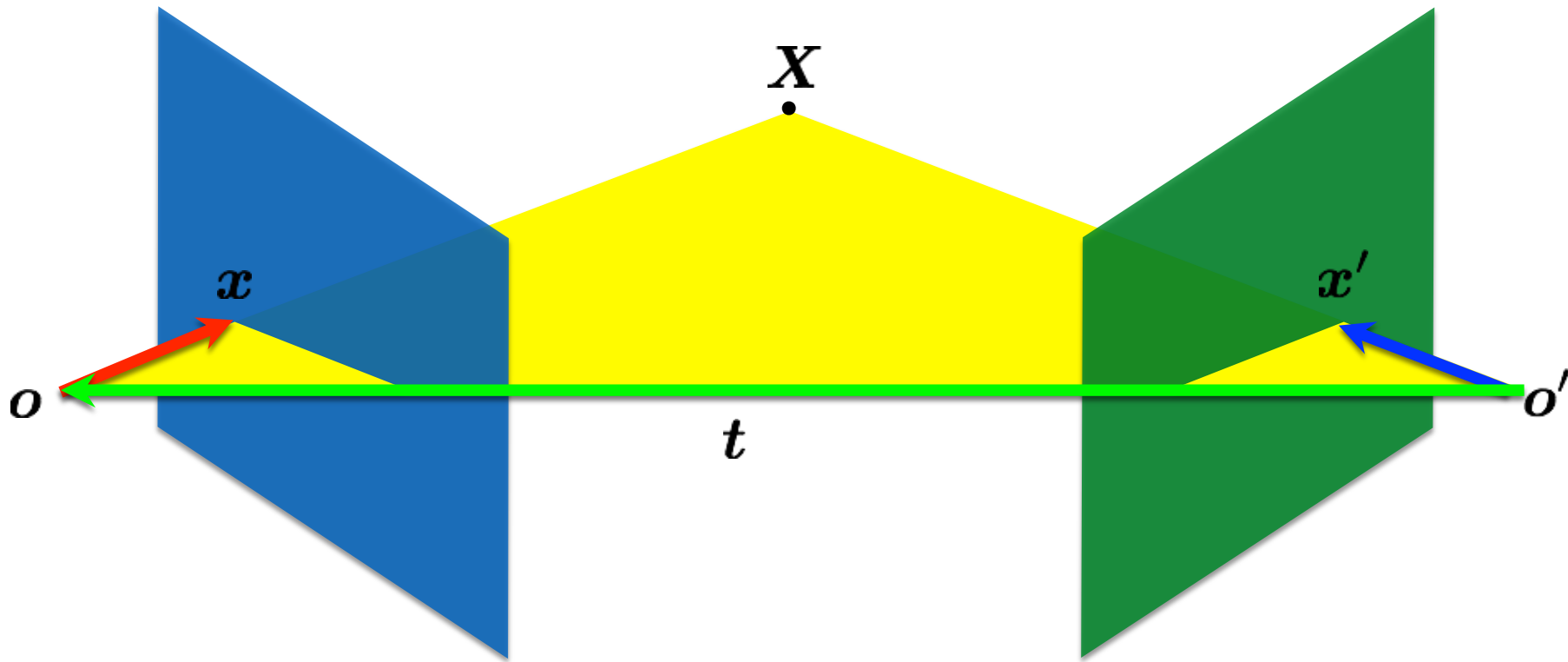

If these three vectors are coplanar $\mathbf{x}, \mathbf{t}, \mathbf{x}'$ then

$$(\mathbf{x} - \mathbf{t})^\top (\mathbf{t} \times \mathbf{x}) = 0$$

putting it together

rigid motion

$$\mathbf{x}' = \mathbf{R}(\mathbf{x} - \mathbf{t})$$

coplanarity

$$(\mathbf{x} - \mathbf{t})^\top (\mathbf{t} \times \mathbf{x}) = 0$$

$$(\mathbf{x}'^\top \mathbf{R})(\mathbf{t} \times \mathbf{x}) = 0$$

putting it together

rigid motion

$$\mathbf{x}' = \mathbf{R}(\mathbf{x} - \mathbf{t})$$

coplanarity

$$(\mathbf{x} - \mathbf{t})^\top (\mathbf{t} \times \mathbf{x}) = 0$$

use skew-symmetric
matrix to represent cross
product

$$(\mathbf{x}'^\top \mathbf{R})(\mathbf{t} \times \mathbf{x}) = 0$$

$$(\mathbf{x}'^\top \mathbf{R})([\mathbf{t}_\times] \mathbf{x}) = 0$$

putting it together

rigid motion

$$\mathbf{x}' = \mathbf{R}(\mathbf{x} - \mathbf{t})$$

coplanarity

$$(\mathbf{x} - \mathbf{t})^\top (\mathbf{t} \times \mathbf{x}) = 0$$

$$(\mathbf{x}'^\top \mathbf{R})(\mathbf{t} \times \mathbf{x}) = 0$$

$$(\mathbf{x}'^\top \mathbf{R})([\mathbf{t}_\times] \mathbf{x}) = 0$$

$$\mathbf{x}'^\top (\mathbf{R}[\mathbf{t}_\times]) \mathbf{x} = 0$$

putting it together

rigid motion

$$\mathbf{x}' = \mathbf{R}(\mathbf{x} - \mathbf{t})$$

coplanarity

$$(\mathbf{x} - \mathbf{t})^\top (\mathbf{t} \times \mathbf{x}) = 0$$

$$(\mathbf{x}'^\top \mathbf{R})(\mathbf{t} \times \mathbf{x}) = 0$$

$$(\mathbf{x}'^\top \mathbf{R})([\mathbf{t}_\times] \mathbf{x}) = 0$$

$$\mathbf{x}'^\top (\mathbf{R}[\mathbf{t}_\times]) \mathbf{x} = 0$$

$$\mathbf{x}'^\top \mathbf{E} \mathbf{x} = 0$$

putting it together

rigid motion

$$\mathbf{x}' = \mathbf{R}(\mathbf{x} - \mathbf{t})$$

coplanarity

$$(\mathbf{x} - \mathbf{t})^\top (\mathbf{t} \times \mathbf{x}) = 0$$

$$(\mathbf{x}'^\top \mathbf{R})(\mathbf{t} \times \mathbf{x}) = 0$$

$$(\mathbf{x}'^\top \mathbf{R})([\mathbf{t}_\times] \mathbf{x}) = 0$$

$$\mathbf{x}'^\top (\mathbf{R}[\mathbf{t}_\times]) \mathbf{x} = 0$$

$$\mathbf{x}'^\top \mathbf{E} \mathbf{x} = 0$$

Essential Matrix

[Longuet-Higgins 1981]

properties of the E matrix

Longuet-Higgins equation

$$\mathbf{x}'^{\top} \mathbf{E} \mathbf{x} = 0$$

(2D points expressed in camera coordinate system)

properties of the E matrix

Longuet-Higgins equation

$$\mathbf{x}'^{\top} \mathbf{E} \mathbf{x} = 0$$

Epipolar lines

$$\mathbf{x}^{\top} \mathbf{l} = 0$$

$$\mathbf{x}'^{\top} \mathbf{l}' = 0$$

$$\mathbf{l}' = \mathbf{E} \mathbf{x}$$

$$\mathbf{l} = \mathbf{E}^{\top} \mathbf{x}'$$

(2D points expressed in camera coordinate system)

properties of the E matrix

Longuet-Higgins equation

$$\mathbf{x}'^{\top} \mathbf{E} \mathbf{x} = 0$$

Epipolar lines

$$\mathbf{x}^{\top} \mathbf{l} = 0$$

$$\mathbf{x}'^{\top} \mathbf{l}' = 0$$

$$\mathbf{l}' = \mathbf{E} \mathbf{x}$$

$$\mathbf{l} = \mathbf{E}^{\top} \mathbf{x}'$$

Epipoles

$$\mathbf{e}'^{\top} \mathbf{E} = \mathbf{0}$$

$$\mathbf{E} \mathbf{e} = \mathbf{0}$$

(2D points expressed in camera coordinate system)

Given a point in one image, multiplying by the **essential matrix** will tell us the **epipolar line** in the second view.

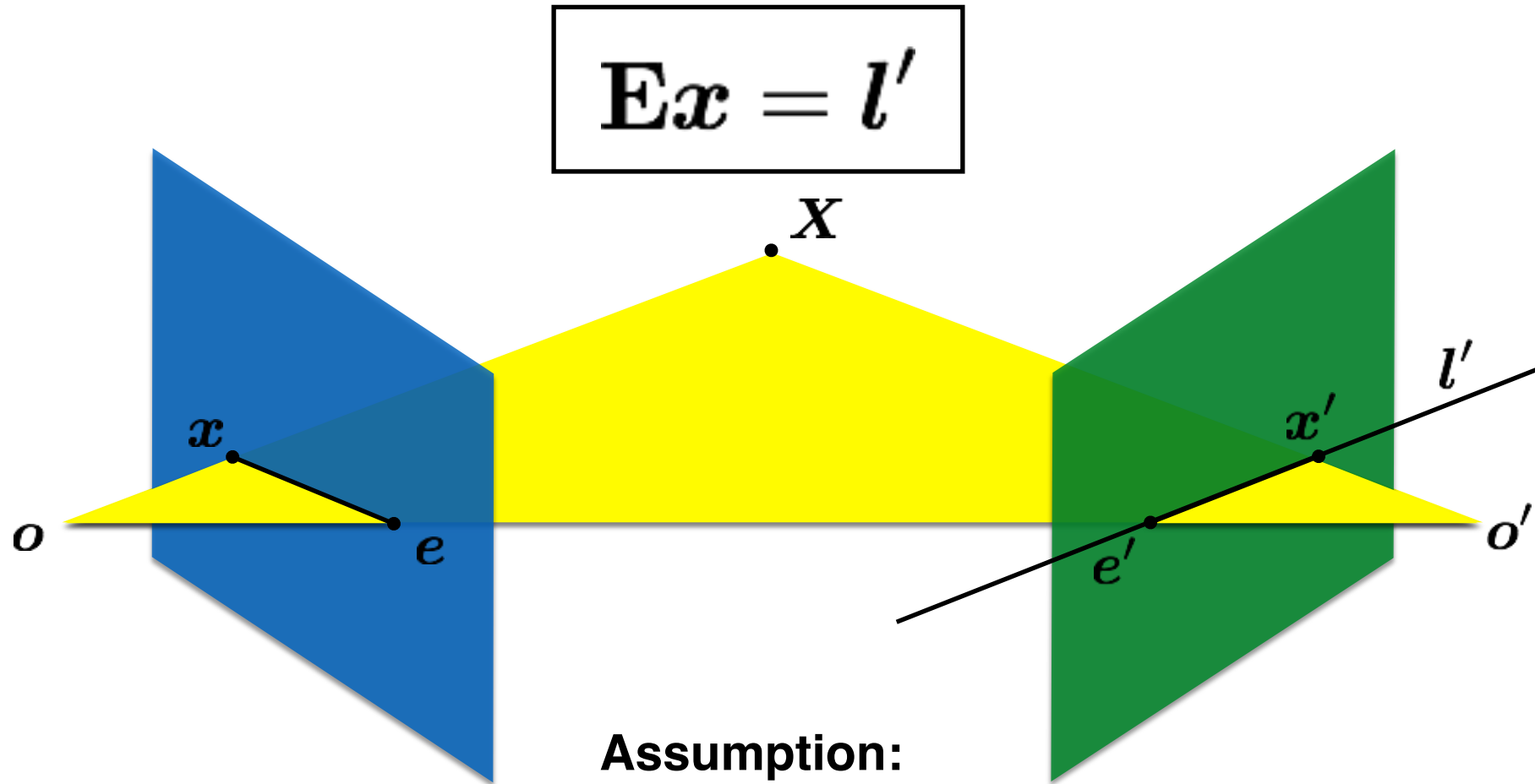

$$\mathbf{E}x = l'$$

Assumption:

2D points expressed in camera coordinate system (i.e., intrinsic matrices are identities)

How do you generalize
to non-identity intrinsic
matrices?

The fundamental matrix

The
fundamental matrix
is a
generalization
of the
essential matrix,
where the assumption of
Identity matrices
is removed

$$\hat{\mathbf{x}}'^{\top} \mathbf{E} \hat{\mathbf{x}} = 0$$

The essential matrix operates on image points expressed in **2D coordinates** expressed in the camera coordinate system

$$\hat{\mathbf{x}}' = \mathbf{K}'^{-1} \mathbf{x}'$$

$$\hat{\mathbf{x}} = \mathbf{K}^{-1} \mathbf{x}$$

camera point image point

$$\hat{\mathbf{x}}'^{\top} \mathbf{E} \hat{\mathbf{x}} = 0$$

The essential matrix operates on image points expressed in **2D coordinates** expressed in the camera coordinate system

$$\hat{\mathbf{x}}' = \mathbf{K}'^{-1} \mathbf{x}'$$

$$\hat{\mathbf{x}} = \mathbf{K}^{-1} \mathbf{x}$$

camera point image point

Writing out the epipolar constraint in terms of image coordinates

$$\mathbf{K}'^{-\top} \mathbf{E} \mathbf{K}^{-1} \mathbf{x} = 0$$
$$\mathbf{x}'^{\top} (\mathbf{K}'^{-\top} \mathbf{E} \mathbf{K}^{-1}) \mathbf{x} = 0$$
$$\mathbf{x}'^{\top} \mathbf{F} \mathbf{x} = 0$$

Same equation works in image coordinates!

$$\mathbf{x}'^T \mathbf{F} \mathbf{x} = 0$$

it maps pixels to epipolar lines

properties of the ~~E~~ matrix

Longuet-Higgins equation

$$\mathbf{x}'^T \mathbf{E} \mathbf{x} = 0$$

Epipolar lines

$$\mathbf{x}^T \mathbf{l} = 0$$

$$\mathbf{x}'^T \mathbf{l}' = 0$$

$$\mathbf{l}' = \mathbf{E} \mathbf{x}$$

$$\mathbf{l} = \mathbf{E}^T \mathbf{x}'$$

Epipoles

$$\mathbf{e}'^T \mathbf{E} = \mathbf{0}$$

$$\mathbf{E} \mathbf{e} = \mathbf{0}$$

(points in **image** coordinates)

Breaking down the fundamental matrix

$$\mathbf{F} = \mathbf{K}'^{-\top} \mathbf{E} \mathbf{K}^{-1}$$

$$\mathbf{F} = \mathbf{K}'^{-\top} [\mathbf{t}_x] \mathbf{R} \mathbf{K}^{-1}$$

Depends on both intrinsic and extrinsic parameters

Breaking down the fundamental matrix

$$\mathbf{F} = \mathbf{K}'^{-\top} \mathbf{E} \mathbf{K}^{-1}$$

$$\mathbf{F} = \mathbf{K}'^{-\top} [\mathbf{t}_x] \mathbf{R} \mathbf{K}^{-1}$$

Depends on both intrinsic and extrinsic parameters

How would you solve for F?

$$\mathbf{x}'^{\top} \mathbf{F} \mathbf{x}_m = 0$$

The 8-point algorithm

Assume you have M matched *image* points

$$\{\mathbf{x}_m, \mathbf{x}'_m\} \quad m = 1, \dots, M$$

Each correspondence should satisfy

$$\mathbf{x}'_m{}^\top \mathbf{F} \mathbf{x}_m = 0$$

How would you solve for the 3 x 3 \mathbf{F} matrix?

Assume you have M matched *image* points

$$\{\mathbf{x}_m, \mathbf{x}'_m\} \quad m = 1, \dots, M$$

Each correspondence should satisfy

$$\mathbf{x}'_m{}^\top \mathbf{F} \mathbf{x}_m = 0$$

How would you solve for the 3 x 3 \mathbf{F} matrix?

SVD!

Assume you have M matched *image* points

$$\{\mathbf{x}_m, \mathbf{x}'_m\} \quad m = 1, \dots, M$$

Each correspondence should satisfy

$$\mathbf{x}'_m{}^\top \mathbf{F} \mathbf{x}_m = 0$$

How would you solve for the 3 x 3 \mathbf{F} matrix?

Set up a homogeneous linear system with 9 unknowns

$$\mathbf{x}'_m{}^\top \mathbf{F} \mathbf{x}_m = 0$$

$$\begin{bmatrix} x'_m & y'_m & 1 \end{bmatrix} \begin{bmatrix} f_1 & f_2 & f_3 \\ f_4 & f_5 & f_6 \\ f_7 & f_8 & f_9 \end{bmatrix} \begin{bmatrix} x_m \\ y_m \\ 1 \end{bmatrix} = 0$$

How many equations do you get from one correspondence?

$$\begin{bmatrix} x'_m & y'_m & 1 \end{bmatrix} \begin{bmatrix} f_1 & f_2 & f_3 \\ f_4 & f_5 & f_6 \\ f_7 & f_8 & f_9 \end{bmatrix} \begin{bmatrix} x_m \\ y_m \\ 1 \end{bmatrix} = 0$$

ONE correspondence gives you ONE equation

$$\begin{aligned} x_m x'_m f_1 + x_m y'_m f_2 + x_m f_3 + \\ y_m x'_m f_4 + y_m y'_m f_5 + y_m f_6 + \\ x'_m f_7 + y'_m f_8 + f_9 = 0 \end{aligned}$$

$$\begin{bmatrix} x'_m & y'_m & 1 \end{bmatrix} \begin{bmatrix} f_1 & f_2 & f_3 \\ f_4 & f_5 & f_6 \\ f_7 & f_8 & f_9 \end{bmatrix} \begin{bmatrix} x_m \\ y_m \\ 1 \end{bmatrix} = 0$$

Set up a homogeneous linear system with 9 unknowns

$$\begin{bmatrix} x_1 x'_1 & x_1 y'_1 & x_1 & y_1 x'_1 & y_1 y'_1 & y_1 & x'_1 & y'_1 & 1 \\ \vdots & \vdots & \vdots & \vdots & \vdots & \vdots & \vdots & \vdots & \vdots \\ x_M x'_M & x_M y'_M & x_M & y_M x'_M & y_M y'_M & y_M & x'_M & y'_M & 1 \end{bmatrix} \begin{bmatrix} f_1 \\ f_2 \\ f_3 \\ f_4 \\ f_5 \\ f_6 \\ f_7 \\ f_8 \\ f_9 \end{bmatrix} = \mathbf{0}$$

How many equations do you need?

Each point pair (according to epipolar constraint)
contributes only one scalar equation

$$\mathbf{x}'_m{}^\top \mathbf{F} \mathbf{x}_m = 0$$

Note: This is different from the Homography estimation
where each point pair contributes 2 equations.

We need at least 8 points

Hence, the 8 point algorithm!

How do you solve a homogeneous linear system?

$$\mathbf{A}\mathbf{X} = \mathbf{0}$$

How do you solve a homogeneous linear system?

$$\mathbf{A}\mathbf{X} = \mathbf{0}$$

Total Least Squares

minimize $\|\mathbf{A}\mathbf{x}\|^2$

subject to $\|\mathbf{x}\|^2 = 1$

How do you solve a homogeneous linear system?

$$\mathbf{A}\mathbf{X} = \mathbf{0}$$

Total Least Squares

minimize $\|\mathbf{A}\mathbf{x}\|^2$

subject to $\|\mathbf{x}\|^2 = 1$

SVD!

Eight-Point Algorithm

0. (Normalize points)
1. Construct the $M \times 9$ matrix \mathbf{A}
2. Find the SVD of \mathbf{A}
3. Entries of \mathbf{F} are the elements of column of \mathbf{V} corresponding to the least singular value
4. (Enforce rank 2 constraint on \mathbf{F})
5. (Un-normalize \mathbf{F})

Eight-Point Algorithm

0. (Normalize points)

1. Construct the $M \times 9$ matrix \mathbf{A}

2. Find the SVD of \mathbf{A}

3. Entries of \mathbf{F} are the elements of column of \mathbf{V} corresponding to the least singular value

4. (Enforce rank 2 constraint on \mathbf{F})

5. (Un-normalize \mathbf{F})

See Hartley-
Zisserman for why we
do this



Eight-Point Algorithm

0. (Normalize points)

1. Construct the $M \times 9$ matrix \mathbf{A}

2. Find the SVD of \mathbf{A}

3. Entries of \mathbf{F} are the elements of column of \mathbf{V} corresponding to the least singular value

4. (Enforce rank 2 constraint on \mathbf{F})

5. (Un-normalize \mathbf{F})



How do we do this?

Eight-Point Algorithm

0. (Normalize points)

1. Construct the $M \times 9$ matrix \mathbf{A}

2. Find the SVD of \mathbf{A}

3. Entries of \mathbf{F} are the elements of column of \mathbf{V} corresponding to the least singular value

4. (Enforce rank 2 constraint on \mathbf{F})

5. (Un-normalize \mathbf{F})

How do we do this?

SVD!

Enforcing rank constraints

Problem: Given a matrix F , find the matrix F' of rank k that is closest to F ,

$$\min_{\substack{F' \\ \text{rank}(F')=k}} \|F - F'\|^2$$

Solution: Compute the singular value decomposition of F ,

$$F = U\Sigma V^T$$

Form a matrix Σ' by replacing all but the k largest singular values in Σ with 0.

Then the problem solution is the matrix F' formed as,

$$F' = U\Sigma'V^T$$

Eight-Point Algorithm

0. (Normalize points)
1. Construct the $M \times 9$ matrix \mathbf{A}
2. Find the SVD of \mathbf{A}
3. Entries of \mathbf{F} are the elements of column of \mathbf{V} corresponding to the least singular value
4. (Enforce rank 2 constraint on \mathbf{F})
5. (Un-normalize \mathbf{F})

Example

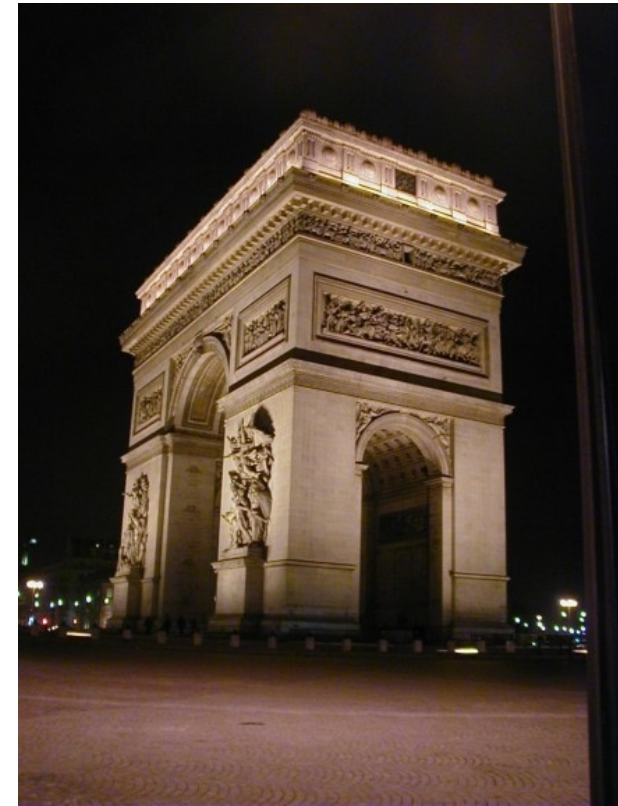

epipolar lines

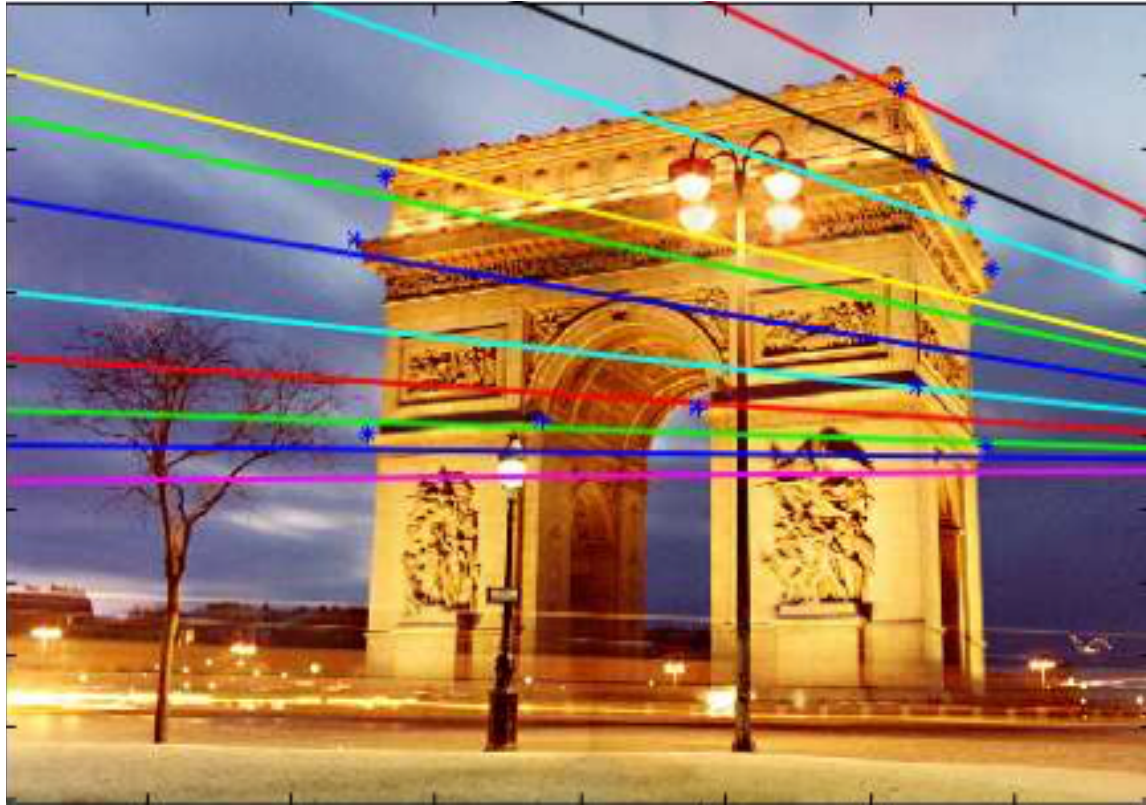

$$\mathbf{F} = \begin{bmatrix} -0.00310695 & -0.0025646 & 2.96584 \\ -0.028094 & -0.00771621 & 56.3813 \\ 13.1905 & -29.2007 & -9999.79 \end{bmatrix}$$

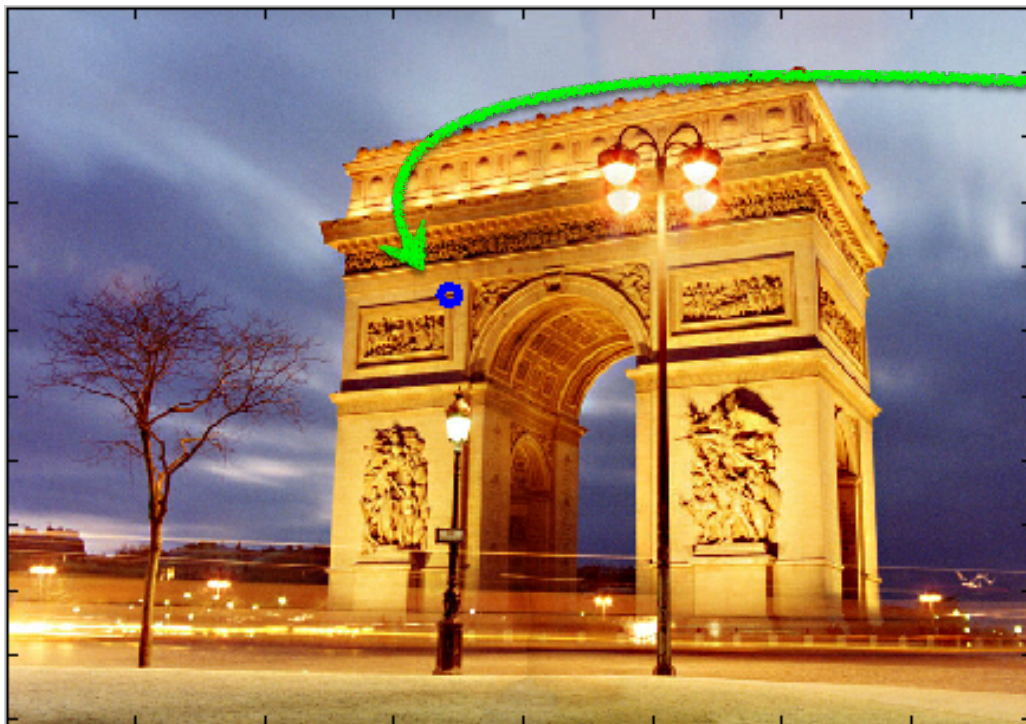

$$\mathbf{x} = \begin{bmatrix} 343.53 \\ 221.70 \\ 1.0 \end{bmatrix}$$

$$\begin{aligned} \mathbf{l}' &= \mathbf{F}\mathbf{x} \\ &= \begin{bmatrix} 0.0295 \\ 0.9996 \\ -265.1531 \end{bmatrix} \end{aligned}$$

$$l' = \mathbf{F}x$$

$$= \begin{bmatrix} 0.0295 \\ 0.9996 \\ -265.1531 \end{bmatrix}$$

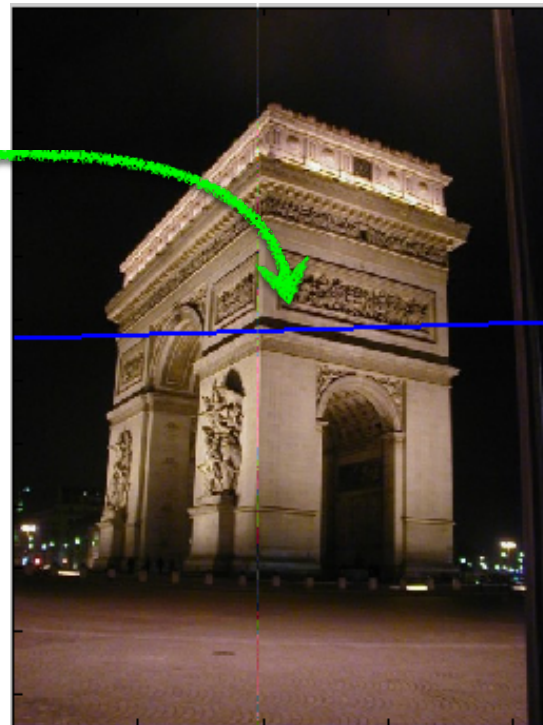

Where is the epipole?



How would you compute it?



$$\mathbf{F}e = \mathbf{0}$$

The epipole is in the right null space of \mathbf{F}

How would you solve for the epipole?

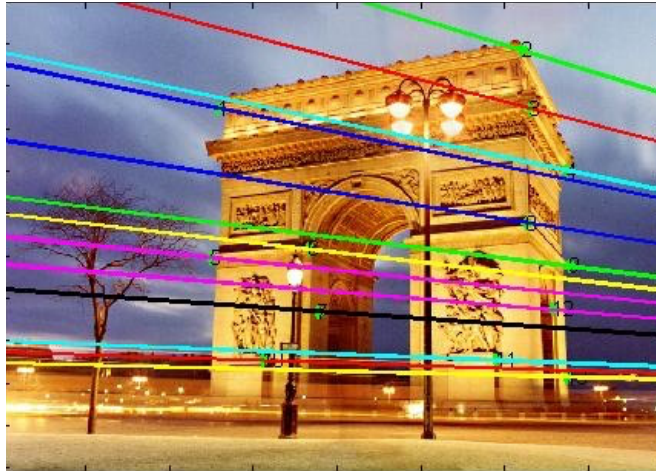

$$\mathbf{F}e = \mathbf{0}$$

The epipole is in the right null space of \mathbf{F}

How would you solve for the epipole?

SVD!