

# Two-view geometry

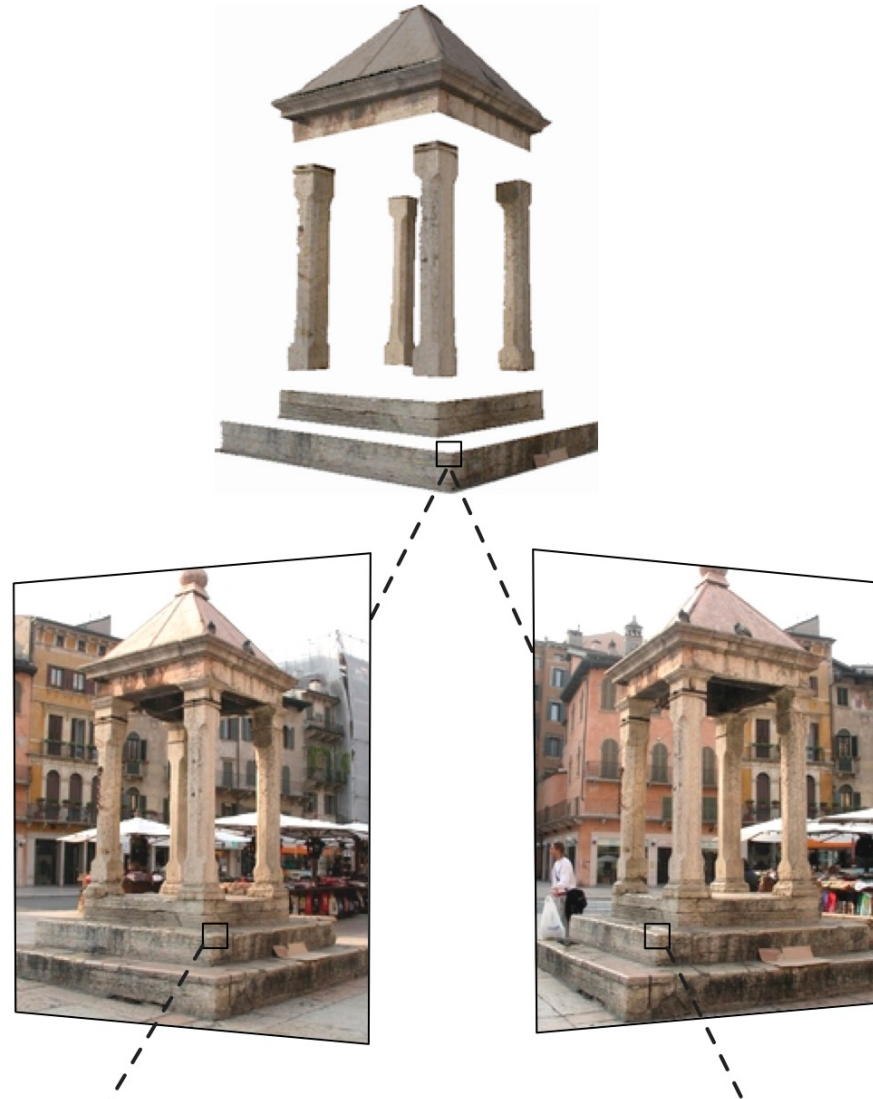

# Overview of today's lecture

- Triangulation.
- Epipolar geometry.
- Essential matrix.
- Fundamental matrix.
- 8-point algorithm.

# Slide credits

Many of these slides were adapted from:

- Kris Kitani (16-385, Spring 2017).
- Srinivasa Narasimhan (16-720, Fall 2017).

# Triangulation

# Triangulation

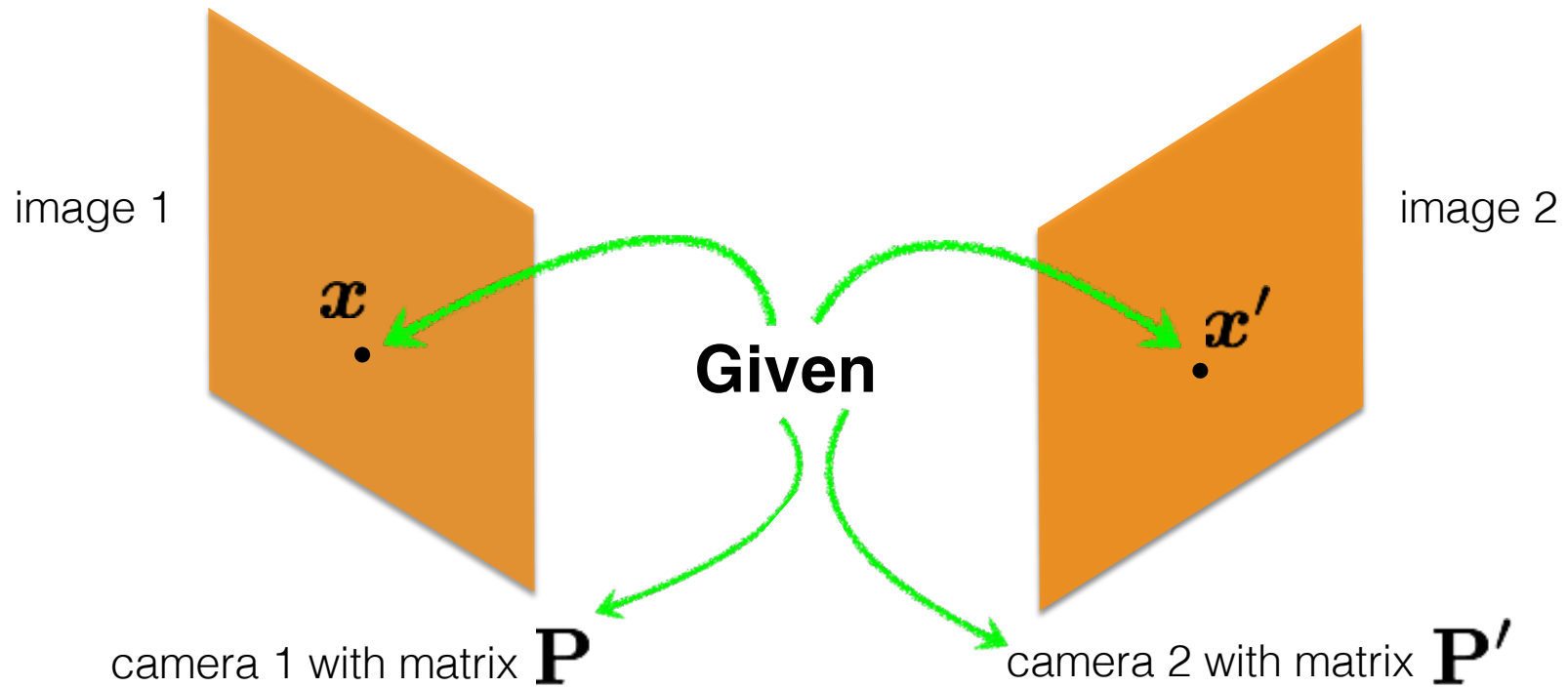

# Triangulation

Which 3D points map  
to  $x$ ?

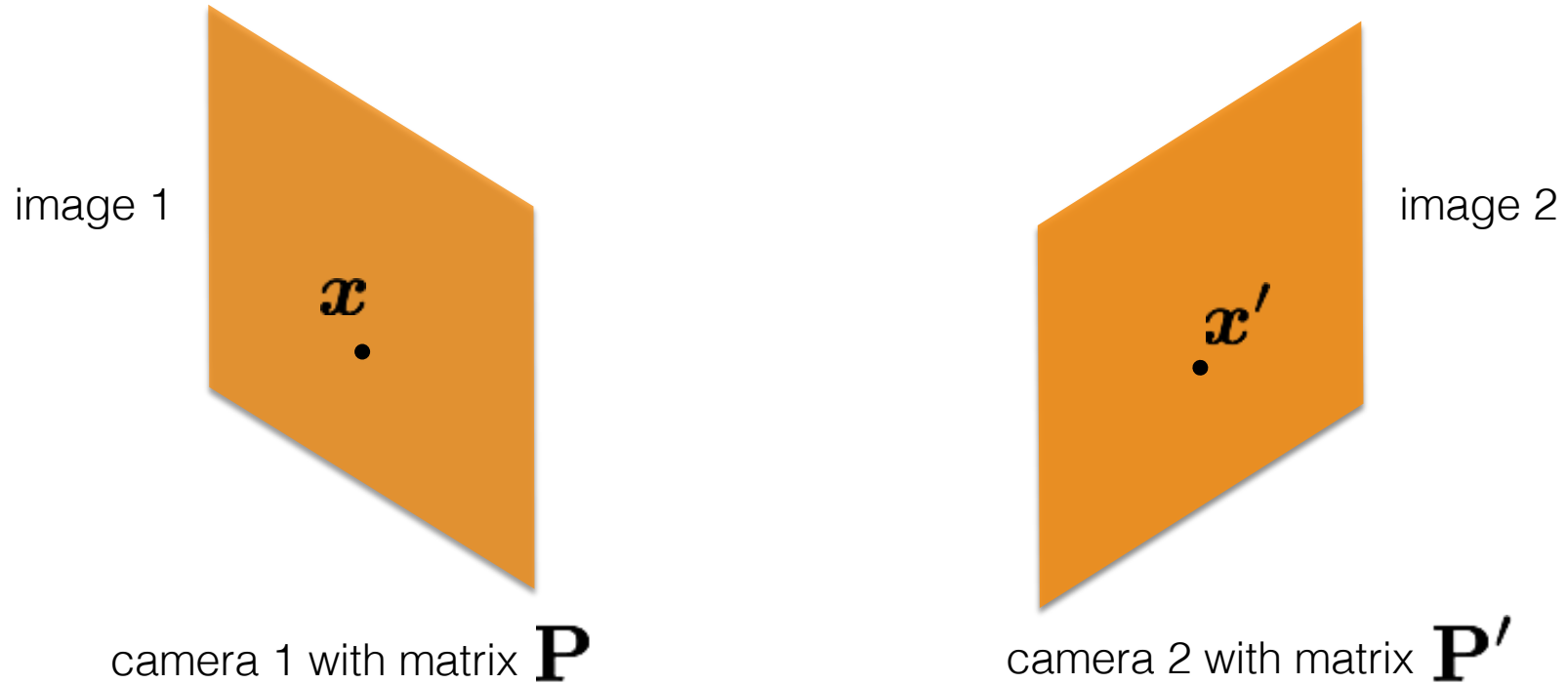

# Triangulation

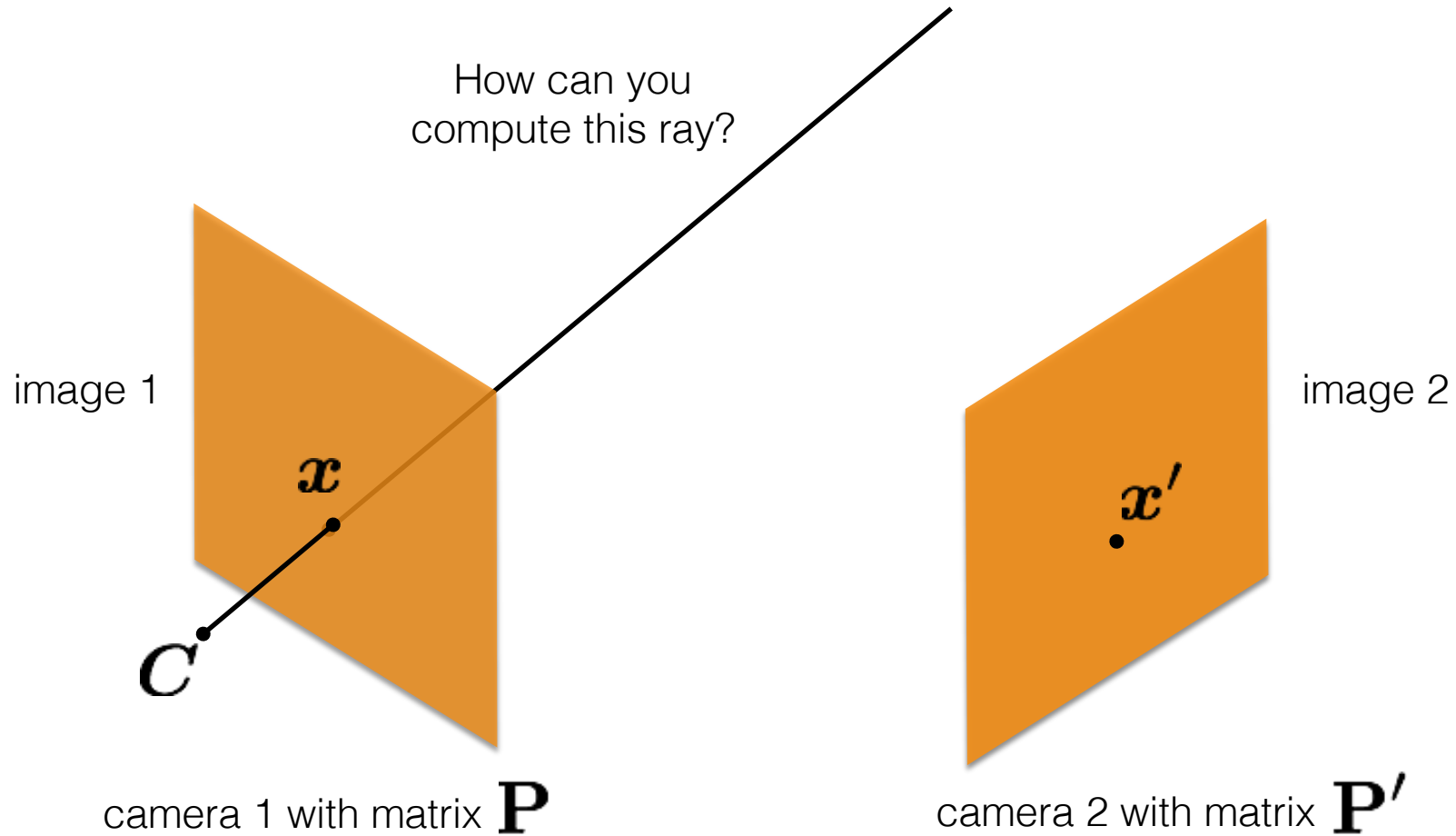

# Triangulation

Create two points on the ray:

- 1) find the camera center; and
  - 2) apply the pseudo-inverse of  $\mathbf{P}$  on  $\mathbf{x}$ .
- Then connect the two points.

This procedure is called backprojection

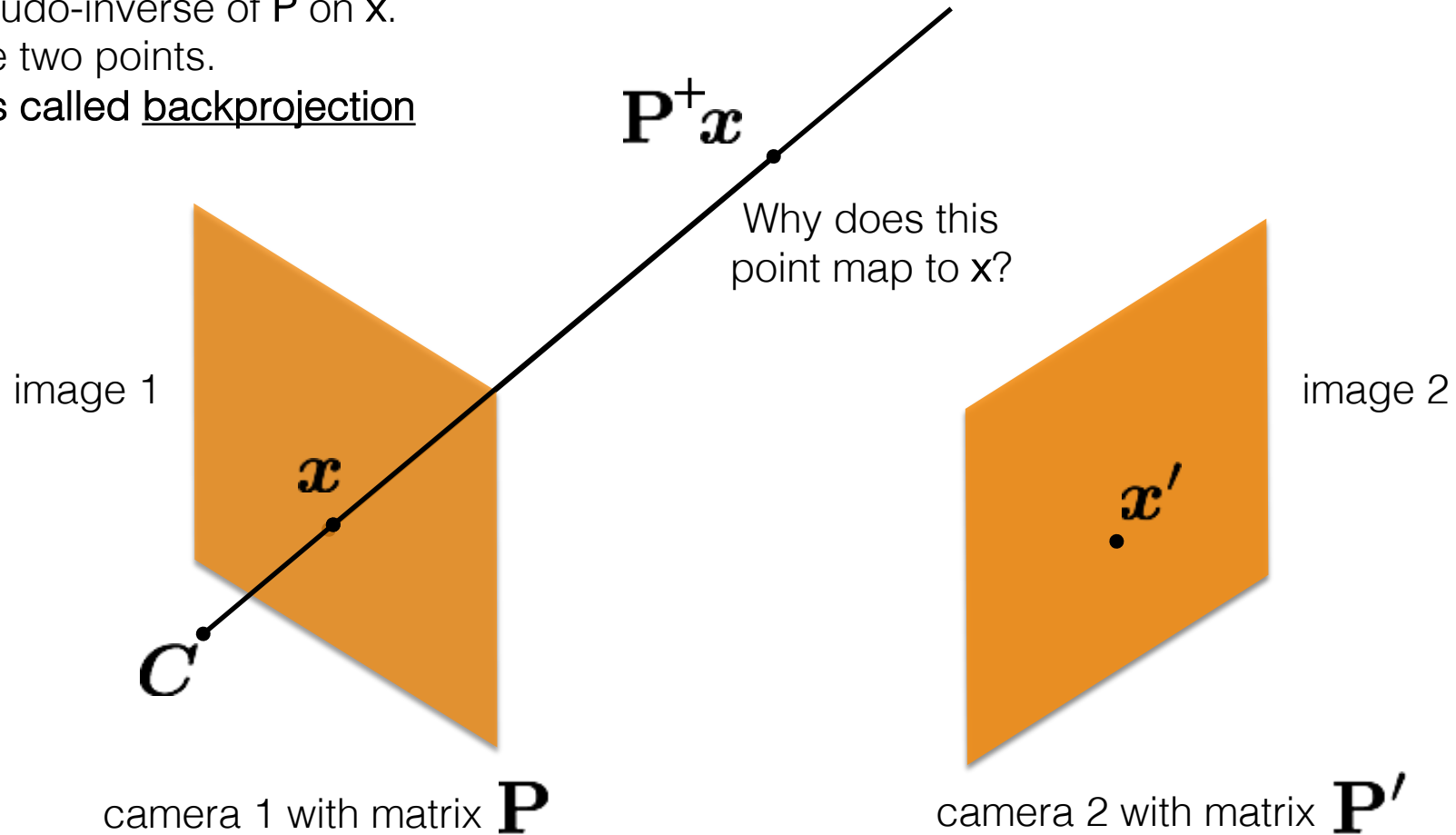



# Triangulation

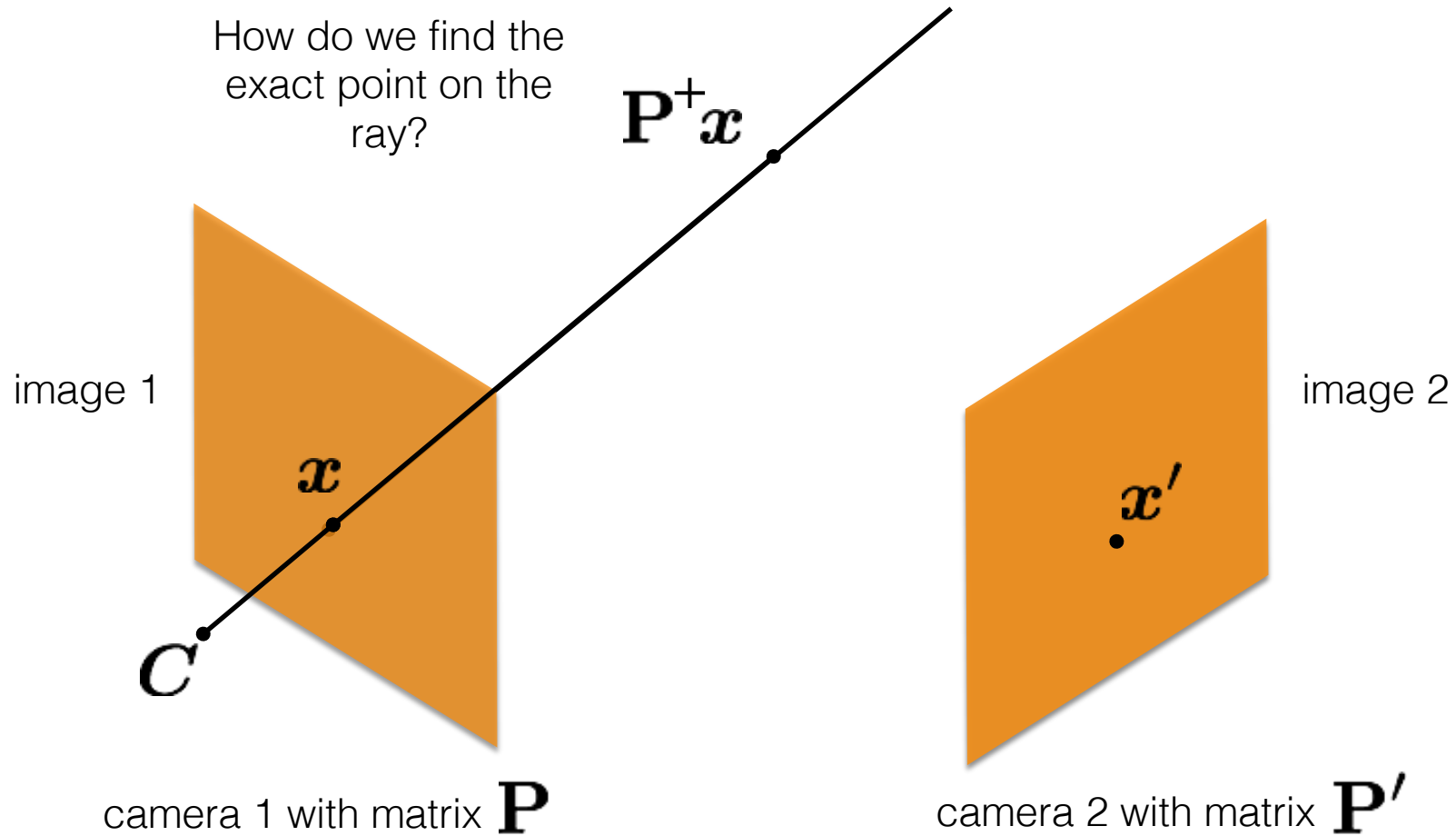

# Triangulation

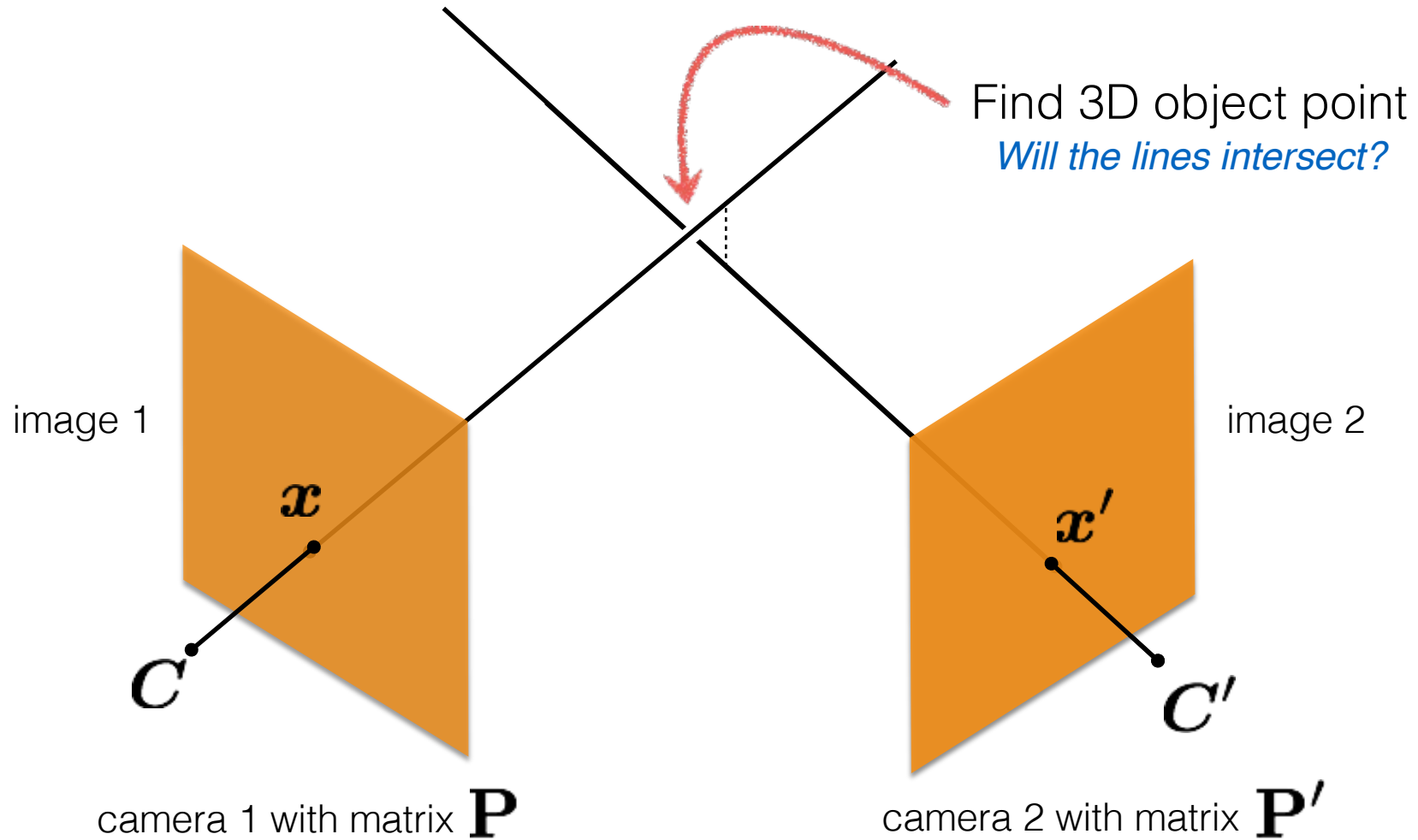

# Triangulation

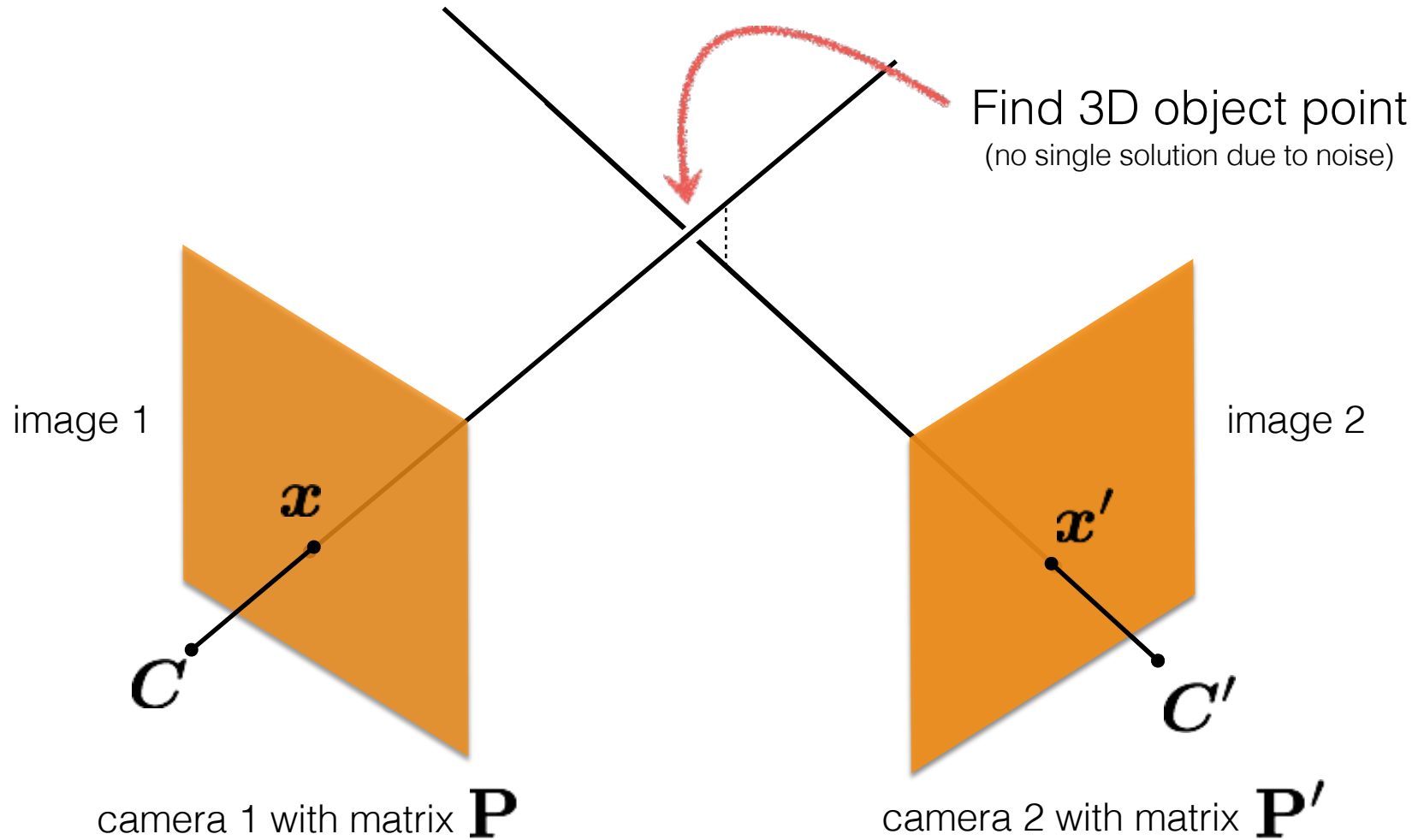

# Triangulation

Given a set of (noisy) matched points

$$\{\mathbf{x}_i, \mathbf{x}'_i\}$$

and camera matrices

$$\mathbf{P}, \mathbf{P}'$$

Estimate the 3D point

$$\mathbf{X}$$

$$\mathbf{x} = \mathbf{P}\mathbf{X}$$

known

known

*Can we compute  $\mathbf{X}$  from a single  
correspondence  $\mathbf{x}$ ?*

$$\mathbf{x} = \mathbf{P}\mathbf{X}$$

(homogeneous  
coordinate)

This is a similarity relation because it involves homogeneous coordinates

$$\mathbf{x} = \alpha\mathbf{P}\mathbf{X}$$

(heterogeneous  
coordinate)

Same ray direction but differs by a scale factor

$$\begin{bmatrix} x \\ y \\ z \end{bmatrix} = \alpha \begin{bmatrix} p_1 & p_2 & p_3 & p_4 \\ p_5 & p_6 & p_7 & p_8 \\ p_9 & p_{10} & p_{11} & p_{12} \end{bmatrix} \begin{bmatrix} X \\ Y \\ Z \\ 1 \end{bmatrix}$$

*How do we solve for unknowns in a similarity relation?*

# Linear algebra reminder: cross product

## Vector (cross) product

takes two vectors and returns a vector perpendicular to both

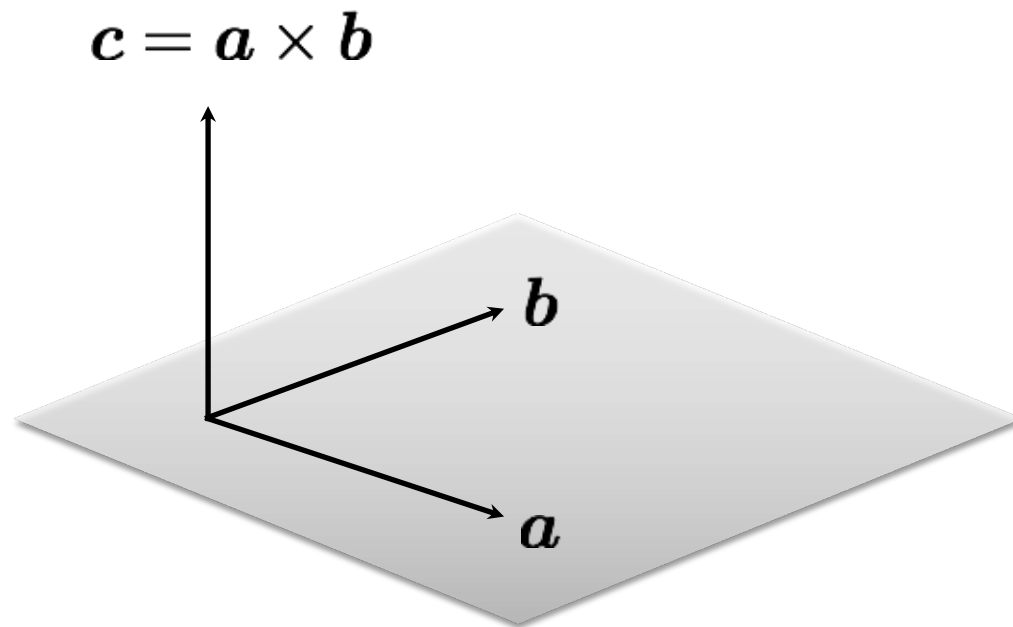

$$\mathbf{c} \cdot \mathbf{a} = 0$$

$$\mathbf{c} \cdot \mathbf{b} = 0$$

$$\mathbf{a} \times \mathbf{b} = \begin{bmatrix} a_2b_3 - a_3b_2 \\ a_3b_1 - a_1b_3 \\ a_1b_2 - a_2b_1 \end{bmatrix}$$

cross product of two vectors in  
the same direction is zero  
vector

$$\mathbf{a} \times \mathbf{a} = \mathbf{0}$$

remember this!!!

# Linear algebra reminder: cross product

Cross product

$$\mathbf{a} \times \mathbf{b} = \begin{bmatrix} a_2 b_3 - a_3 b_2 \\ a_3 b_1 - a_1 b_3 \\ a_1 b_2 - a_2 b_1 \end{bmatrix}$$

Can also be written as a matrix multiplication

$$\mathbf{a} \times \mathbf{b} = [\mathbf{a}]_{\times} \mathbf{b} = \begin{bmatrix} 0 & -a_3 & a_2 \\ a_3 & 0 & -a_1 \\ -a_2 & a_1 & 0 \end{bmatrix} \begin{bmatrix} b_1 \\ b_2 \\ b_3 \end{bmatrix}$$

**Skew symmetric**



# Compare with: dot product

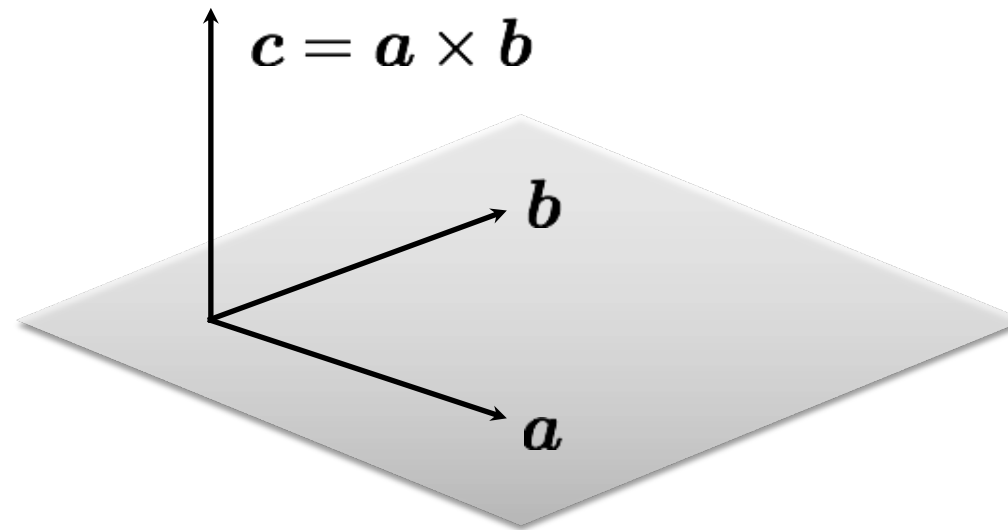

$$c \cdot a = 0$$

$$c \cdot b = 0$$

dot product of two orthogonal vectors is (scalar) zero

# Back to triangulation

$$\mathbf{x} = \alpha \mathbf{P} \mathbf{X}$$

Same direction but differs by a scale factor

*How can we rewrite this using vector products?*

$$\mathbf{x} = \alpha \mathbf{P} \mathbf{X}$$

Same direction but differs by a scale factor

$$\mathbf{x} \times \mathbf{P} \mathbf{X} = \mathbf{0}$$

Cross product of two vectors of same direction is zero  
(this equality removes the scale factor)

$$\begin{bmatrix} x \\ y \\ z \end{bmatrix} = \alpha \begin{bmatrix} p_1 & p_2 & p_3 & p_4 \\ p_5 & p_6 & p_7 & p_8 \\ p_9 & p_{10} & p_{11} & p_{12} \end{bmatrix} \begin{bmatrix} X \\ Y \\ Z \\ 1 \end{bmatrix}$$

$$\begin{bmatrix} x \\ y \\ z \end{bmatrix} = \alpha \begin{bmatrix} \text{---} & \mathbf{p}_1^\top & \text{---} \\ \text{---} & \mathbf{p}_2^\top & \text{---} \\ \text{---} & \mathbf{p}_3^\top & \text{---} \end{bmatrix} \begin{bmatrix} | \\ \mathbf{X} \\ | \end{bmatrix}$$

Do the same after first  
expanding out the  
camera matrix and points

$$\begin{bmatrix} x \\ y \\ z \end{bmatrix} = \alpha \begin{bmatrix} \mathbf{p}_1^\top \mathbf{X} \\ \mathbf{p}_2^\top \mathbf{X} \\ \mathbf{p}_3^\top \mathbf{X} \end{bmatrix}$$

$$\begin{bmatrix} x \\ y \\ 1 \end{bmatrix} \times \begin{bmatrix} \mathbf{p}_1^\top \mathbf{X} \\ \mathbf{p}_2^\top \mathbf{X} \\ \mathbf{p}_3^\top \mathbf{X} \end{bmatrix} = \begin{bmatrix} y\mathbf{p}_3^\top \mathbf{X} - \mathbf{p}_2^\top \mathbf{X} \\ \mathbf{p}_1^\top \mathbf{X} - x\mathbf{p}_3^\top \mathbf{X} \\ x\mathbf{p}_2^\top \mathbf{X} - y\mathbf{p}_1^\top \mathbf{X} \end{bmatrix} = \begin{bmatrix} 0 \\ 0 \\ 0 \end{bmatrix}$$

Using the fact that the cross product should be zero

$$\mathbf{x} \times \mathbf{P}\mathbf{X} = \mathbf{0}$$

$$\begin{bmatrix} yp_3^\top \mathbf{X} - p_2^\top \mathbf{X} \\ p_1^\top \mathbf{X} - xp_3^\top \mathbf{X} \\ xp_2^\top \mathbf{X} - yp_1^\top \mathbf{X} \end{bmatrix} = \begin{bmatrix} 0 \\ 0 \\ 0 \end{bmatrix}$$

Third line is a linear combination of the first and second lines.  
(x times the first line plus y times the second line)

One 2D to 3D point correspondence give you  equations

Using the fact that the cross product should be zero

$$\mathbf{x} \times \mathbf{P}\mathbf{X} = \mathbf{0}$$

$$\begin{bmatrix} yp_3^\top \mathbf{X} - p_2^\top \mathbf{X} \\ p_1^\top \mathbf{X} - xp_3^\top \mathbf{X} \\ xp_2^\top \mathbf{X} - yp_1^\top \mathbf{X} \end{bmatrix} = \begin{bmatrix} 0 \\ 0 \\ 0 \end{bmatrix}$$

Third line is a linear combination of the first and second lines.  
(x times the first line plus y times the second line)

One 2D to 3D point correspondence give you 2 equations

$$\begin{bmatrix} y\mathbf{p}_3^\top \mathbf{X} - \mathbf{p}_2^\top \mathbf{X} \\ \mathbf{p}_1^\top \mathbf{X} - x\mathbf{p}_3^\top \mathbf{X} \end{bmatrix} = \begin{bmatrix} 0 \\ 0 \end{bmatrix}$$

Remove third row, and  
rearrange as system on  
unknowns

$$\begin{bmatrix} y\mathbf{p}_3^\top - \mathbf{p}_2^\top \\ \mathbf{p}_1^\top - x\mathbf{p}_3^\top \end{bmatrix} \mathbf{X} = \begin{bmatrix} 0 \\ 0 \end{bmatrix}$$

$$\mathbf{A}_i \mathbf{X} = \mathbf{0}$$

Now we can make a system of linear equations  
(two lines for each 2D point correspondence)

Concatenate the 2D points from both images

Two rows from  
camera one

Two rows from  
camera two

$$\begin{bmatrix} y\mathbf{p}_3^\top - \mathbf{p}_2^\top \\ \mathbf{p}_1^\top - x\mathbf{p}_3^\top \\ y'\mathbf{p}'_3{}^\top - \mathbf{p}'_2{}^\top \\ \mathbf{p}'_1{}^\top - x'\mathbf{p}'_3{}^\top \end{bmatrix} \mathbf{X} = \begin{bmatrix} 0 \\ 0 \\ 0 \\ 0 \end{bmatrix}$$

*sanity check! dimensions?*

$$\mathbf{A}\mathbf{X} = \mathbf{0}$$

*How do we solve homogeneous linear system?*



Concatenate the 2D points from both images

$$\begin{bmatrix} y\mathbf{p}_3^\top - \mathbf{p}_2^\top \\ \mathbf{p}_1^\top - x\mathbf{p}_3^\top \\ y'\mathbf{p}'_3{}^\top - \mathbf{p}'_2{}^\top \\ \mathbf{p}'_1{}^\top - x'\mathbf{p}'_3{}^\top \end{bmatrix} \mathbf{X} = \begin{bmatrix} 0 \\ 0 \\ 0 \\ 0 \end{bmatrix}$$

$$\mathbf{A}\mathbf{X} = \mathbf{0}$$

*How do we solve homogeneous linear system?*

SVD!

# Epipolar geometry

# Epipolar geometry

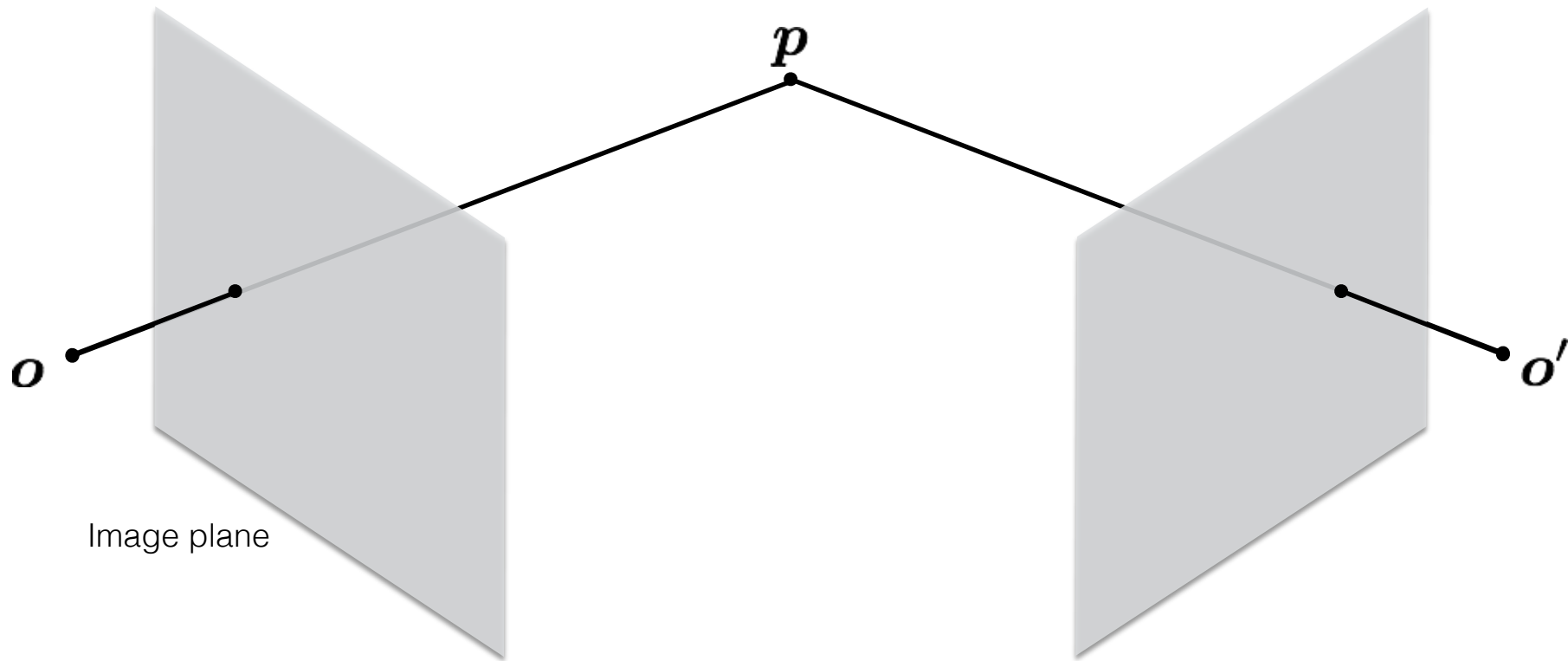

# Epipolar geometry

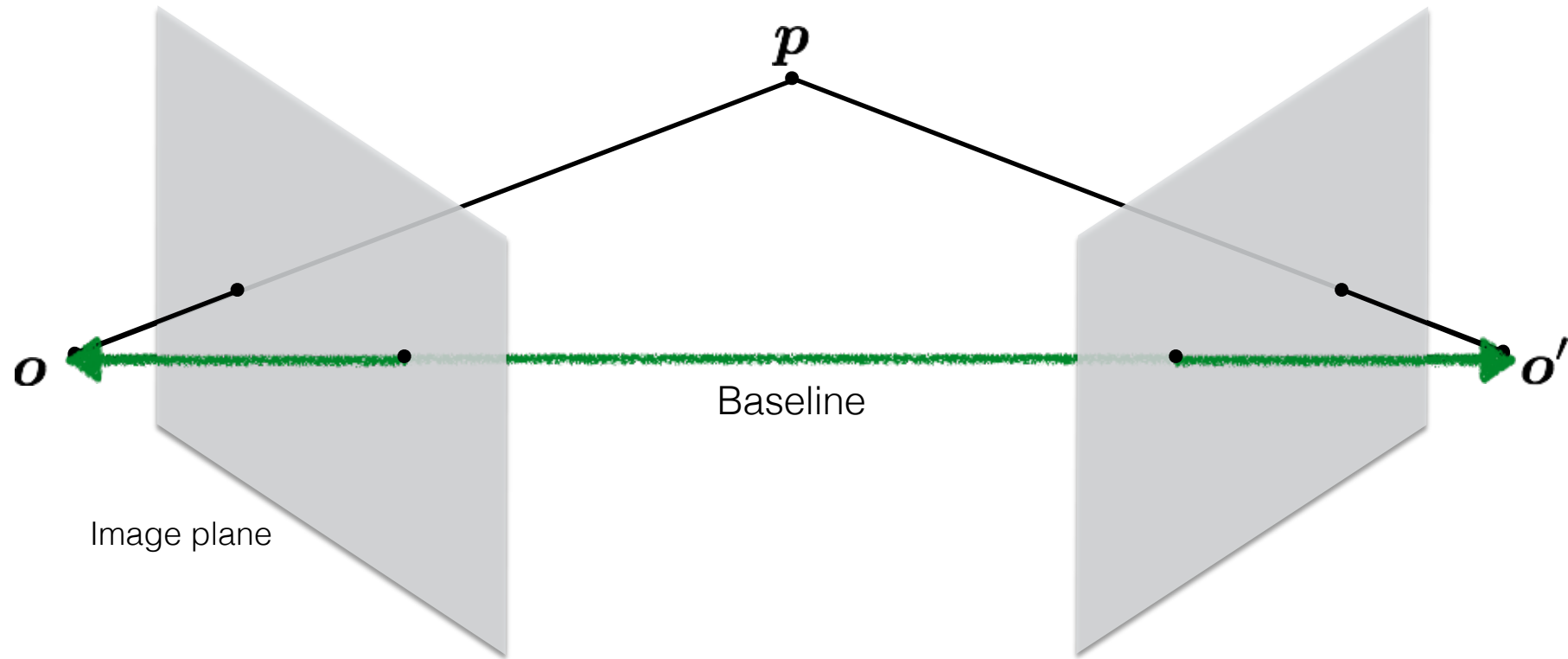

# Epipolar geometry

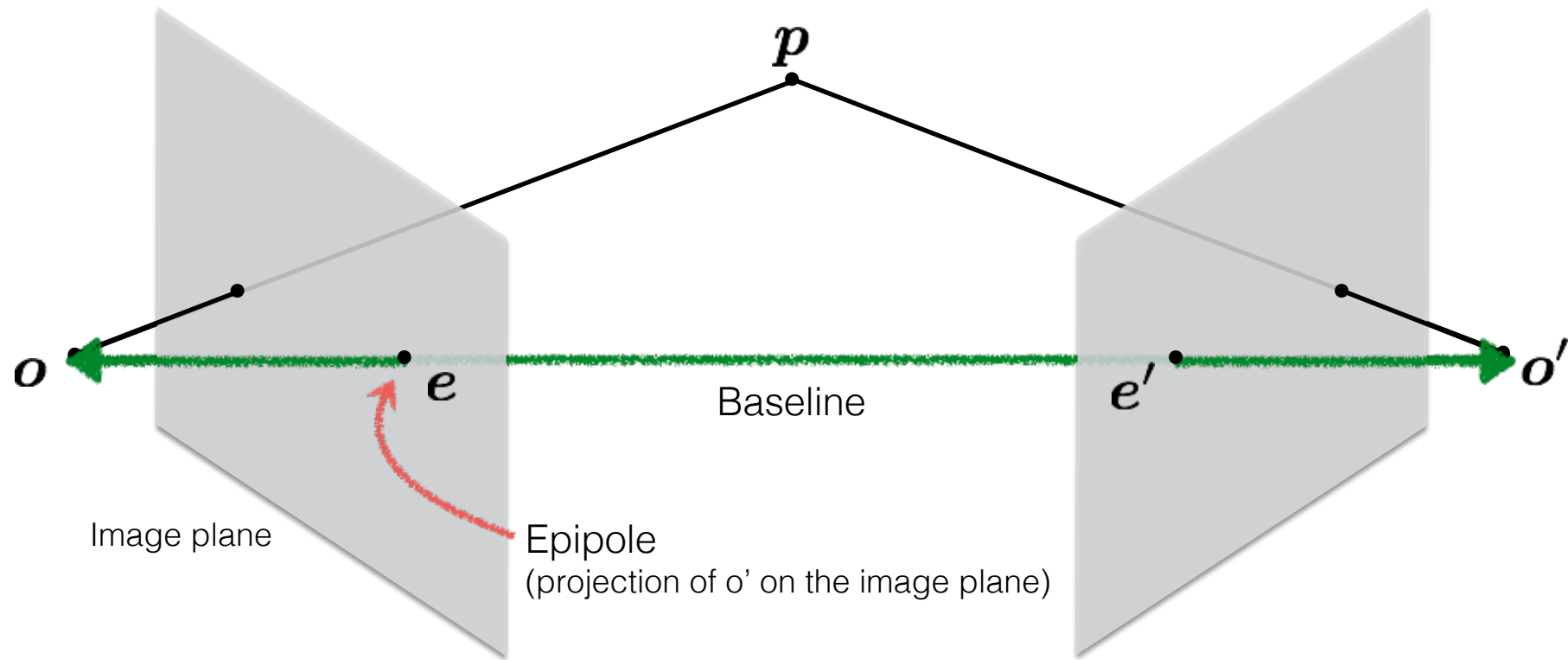

# Epipolar geometry

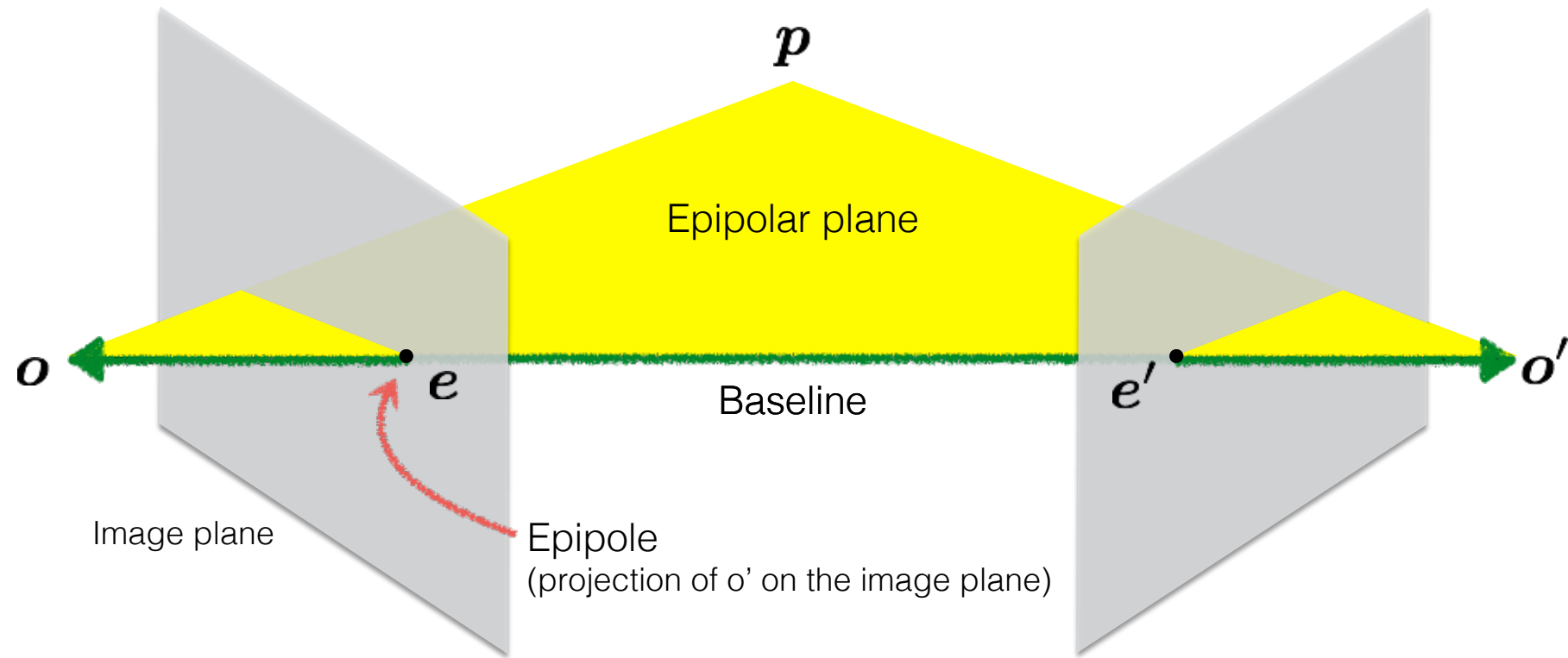

# Epipolar geometry

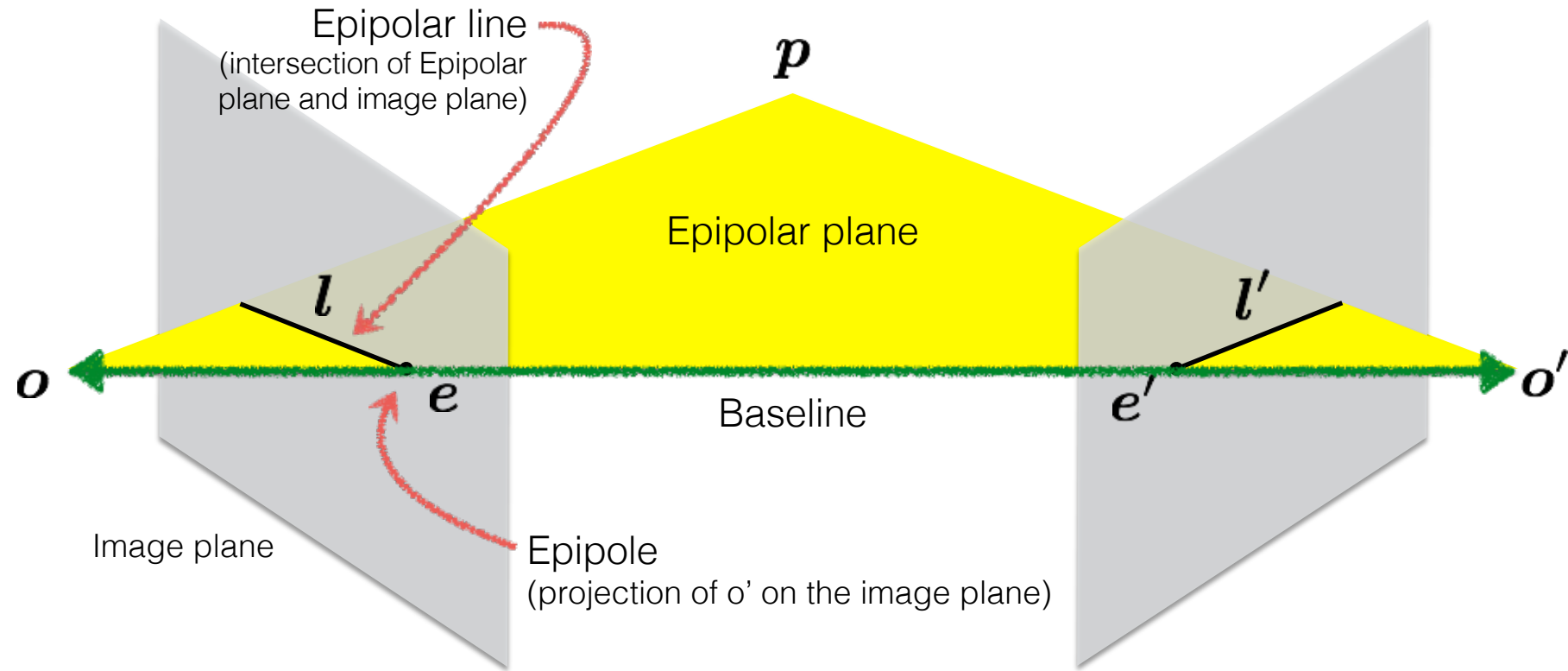

# Quiz

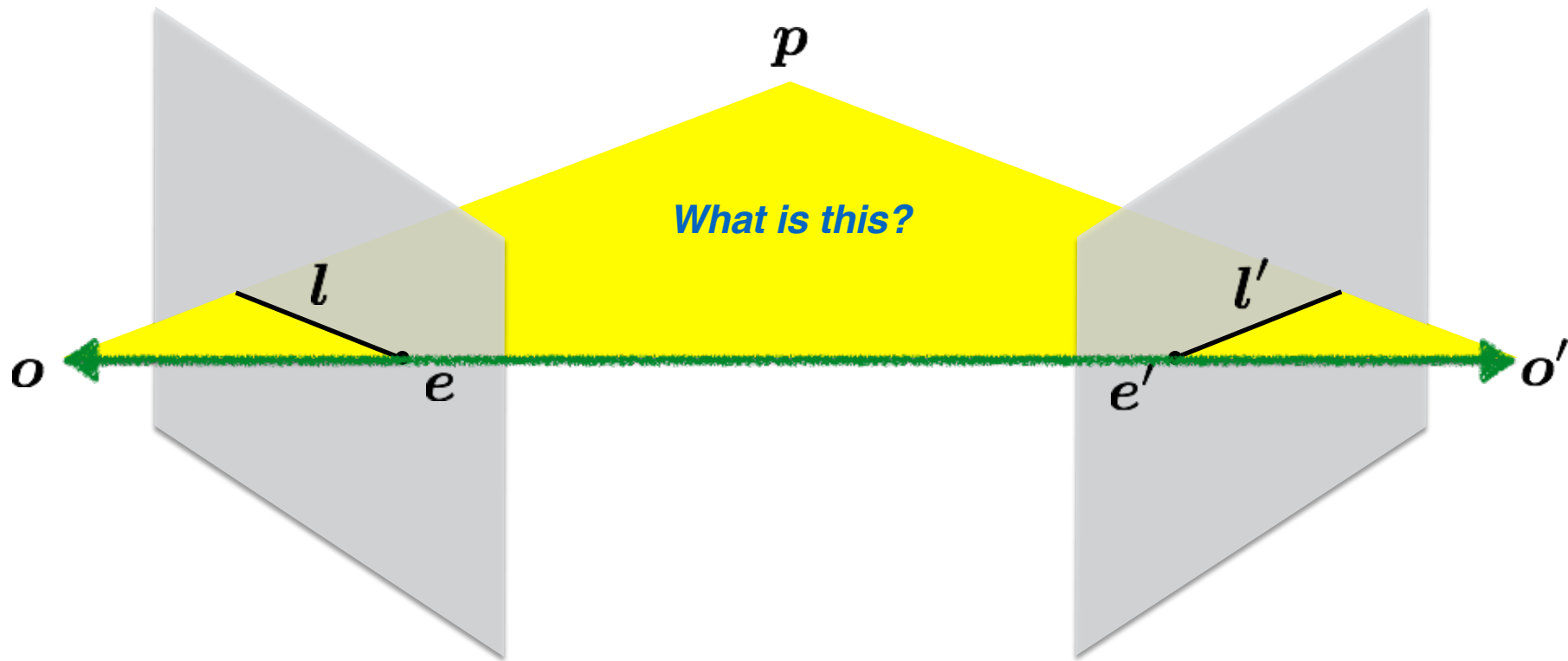



# Quiz

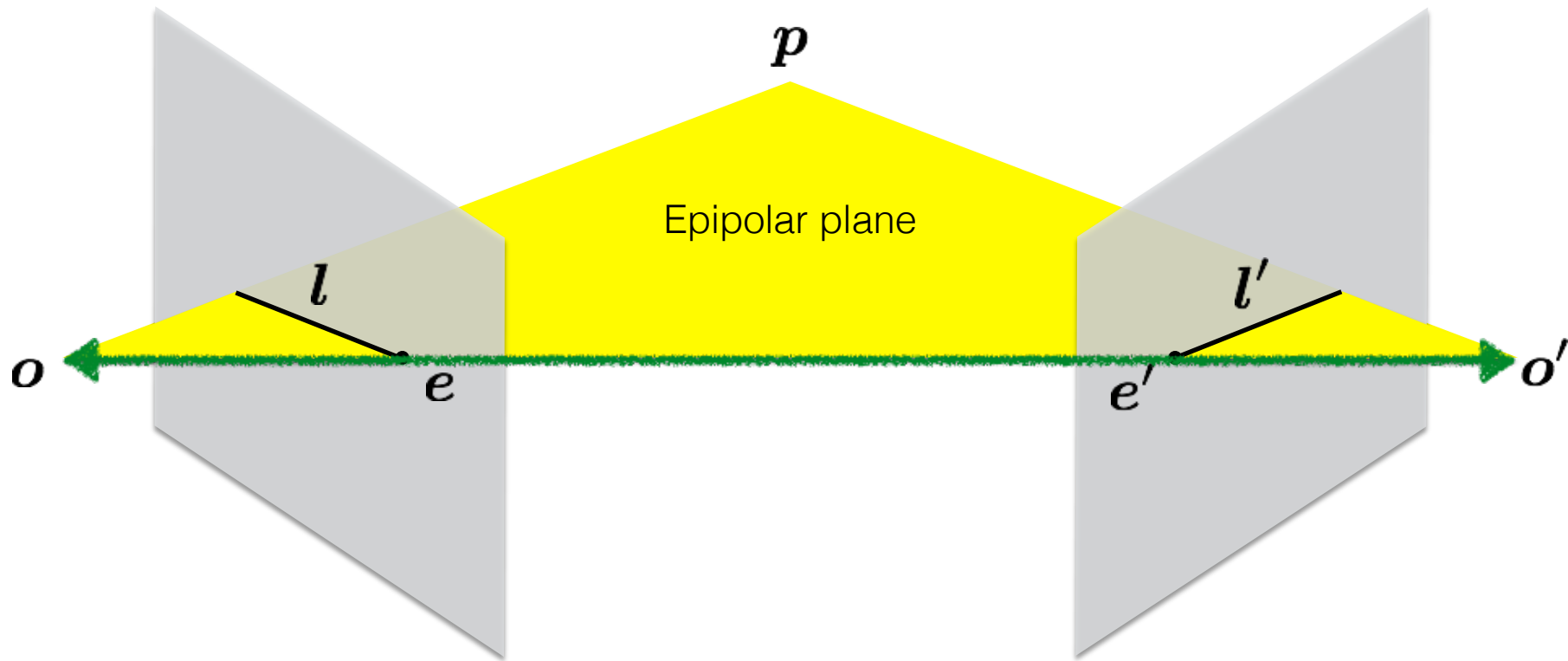

# Quiz

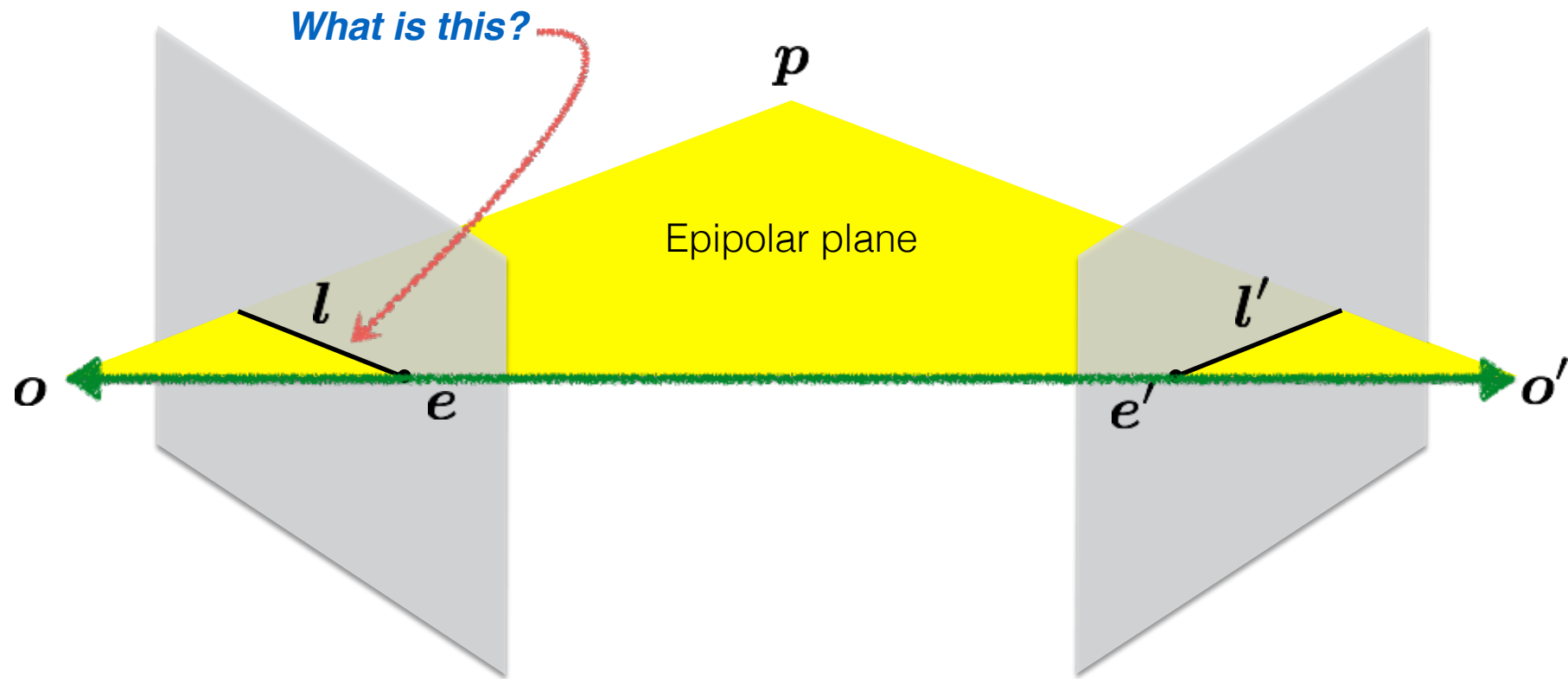

# Quiz

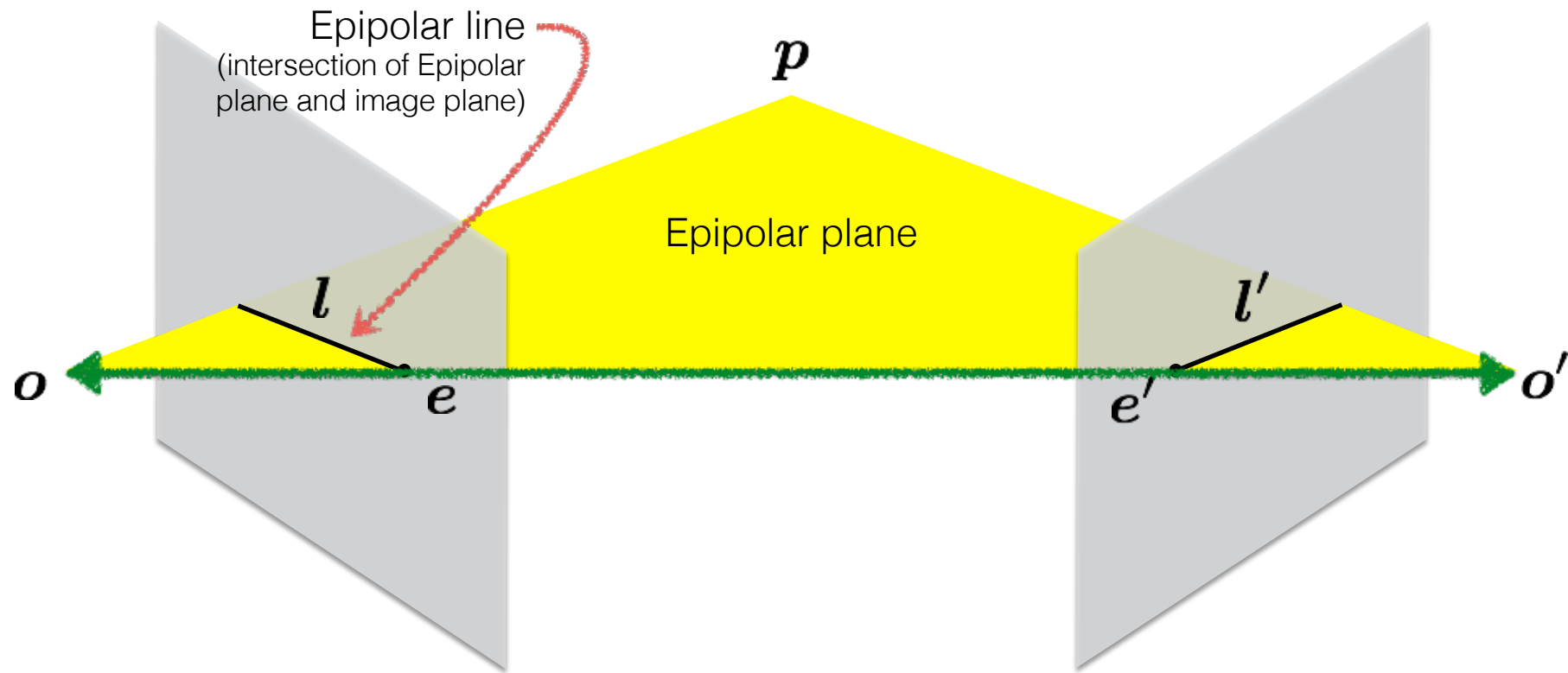

# Quiz

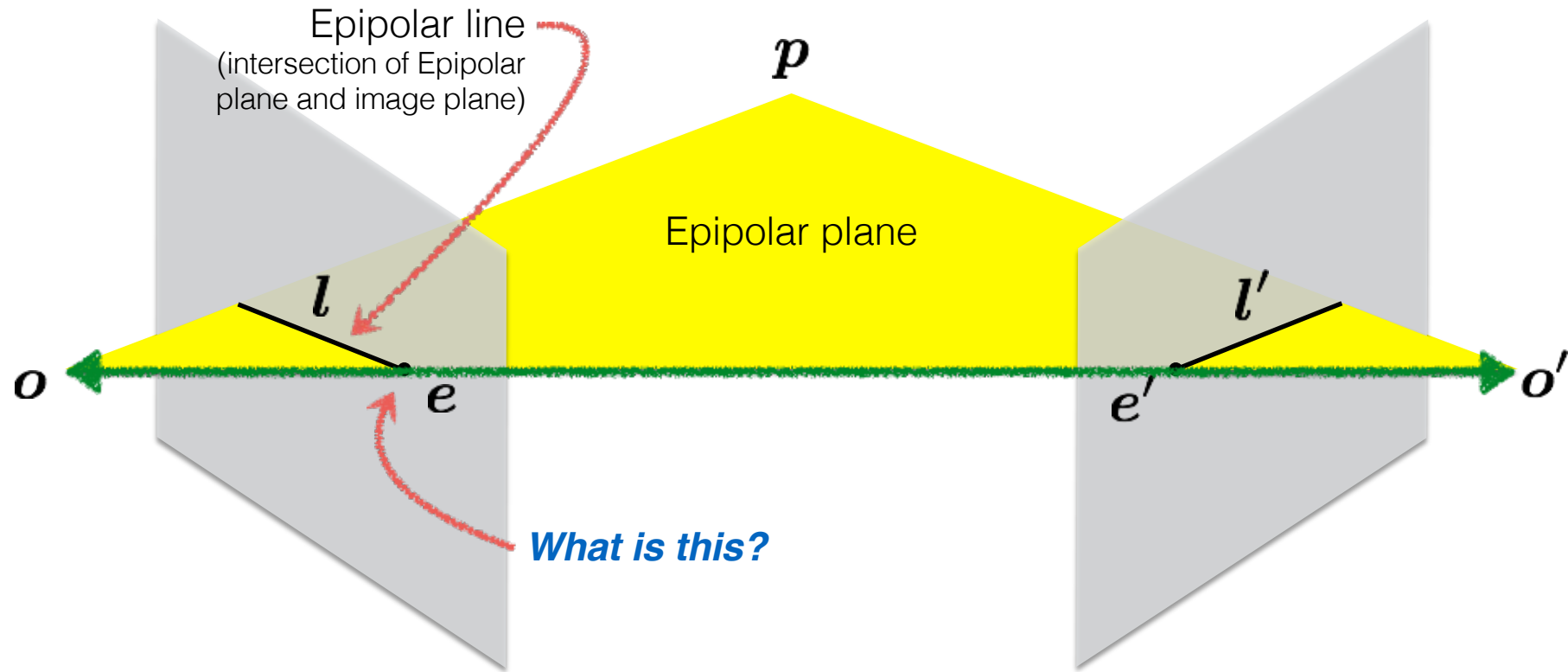

# Quiz

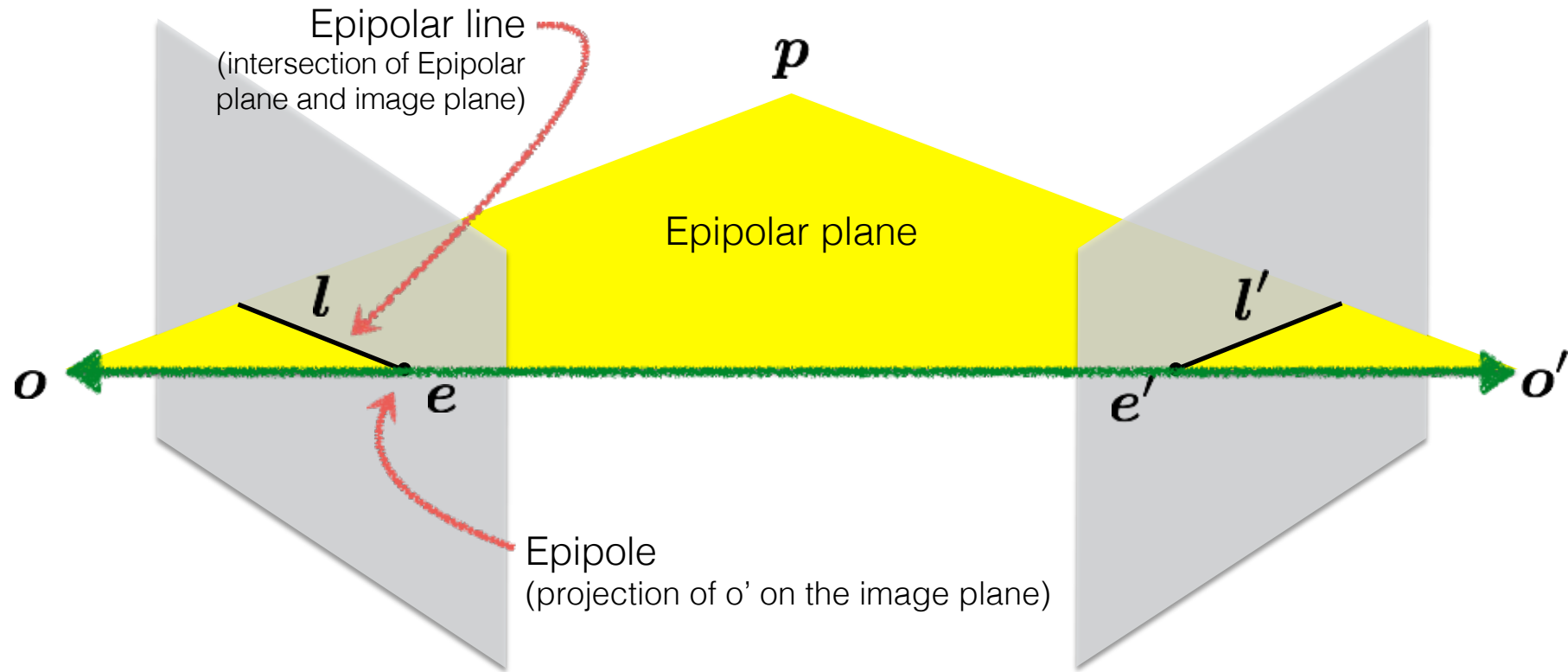

# Quiz

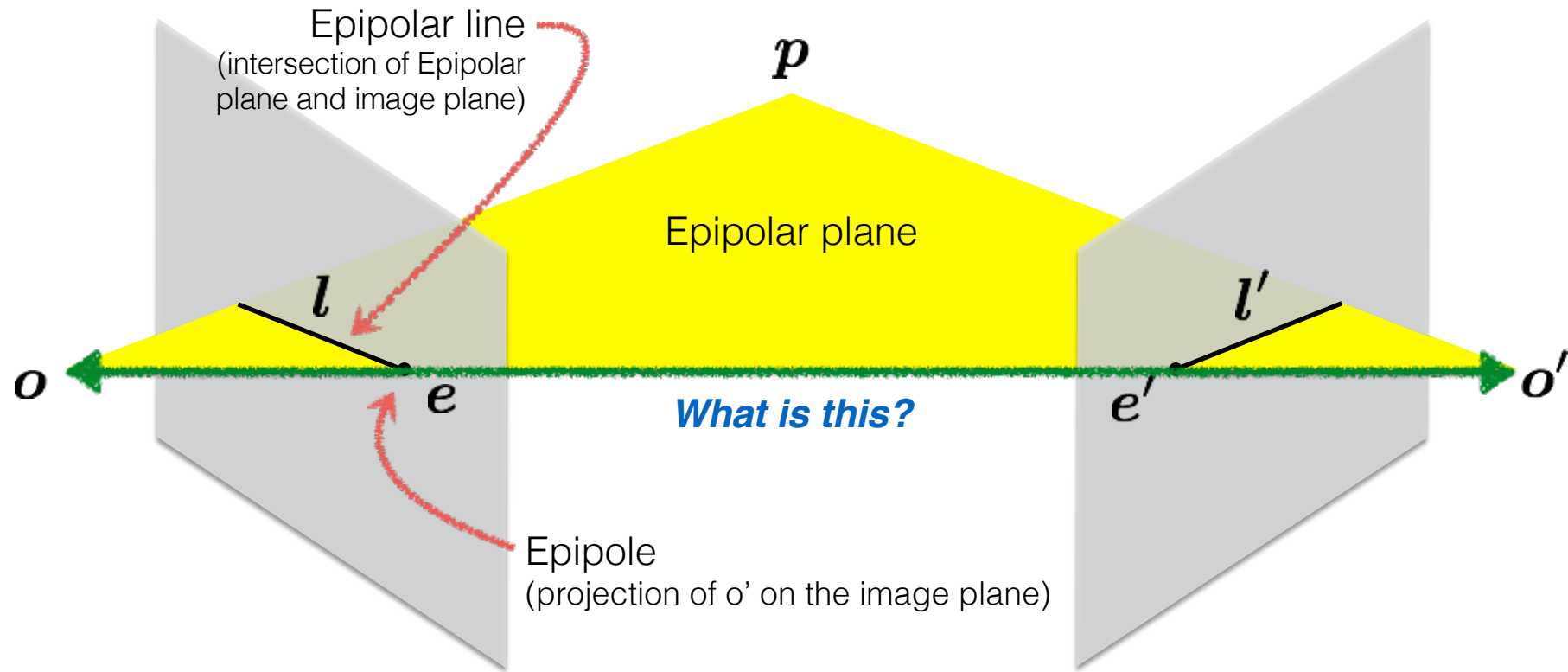

# Quiz

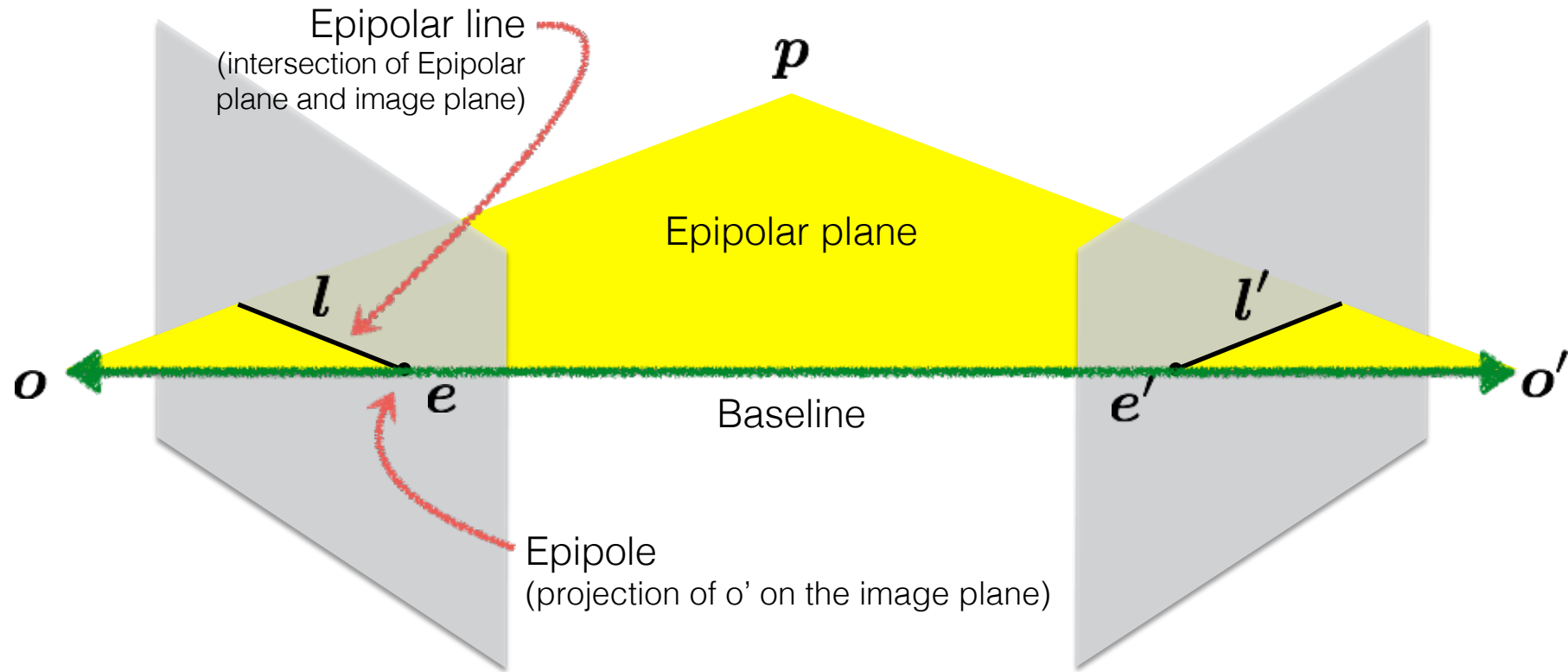

# Epipolar constraint

Backproject  $\mathbf{x}$  to a ray in 3D

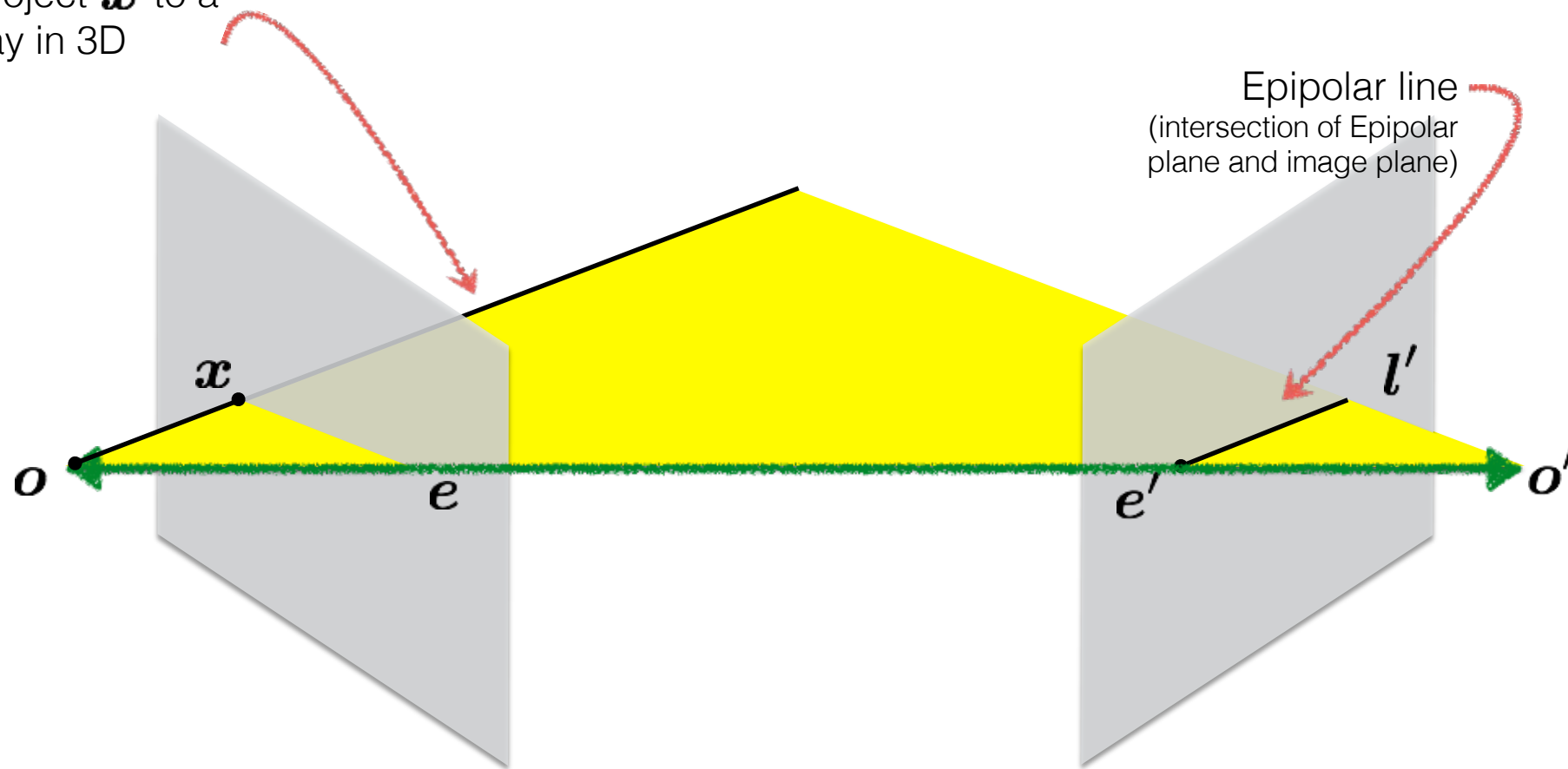

Another way to construct the epipolar plane, this time given  $\mathbf{x}$



# Epipolar constraint

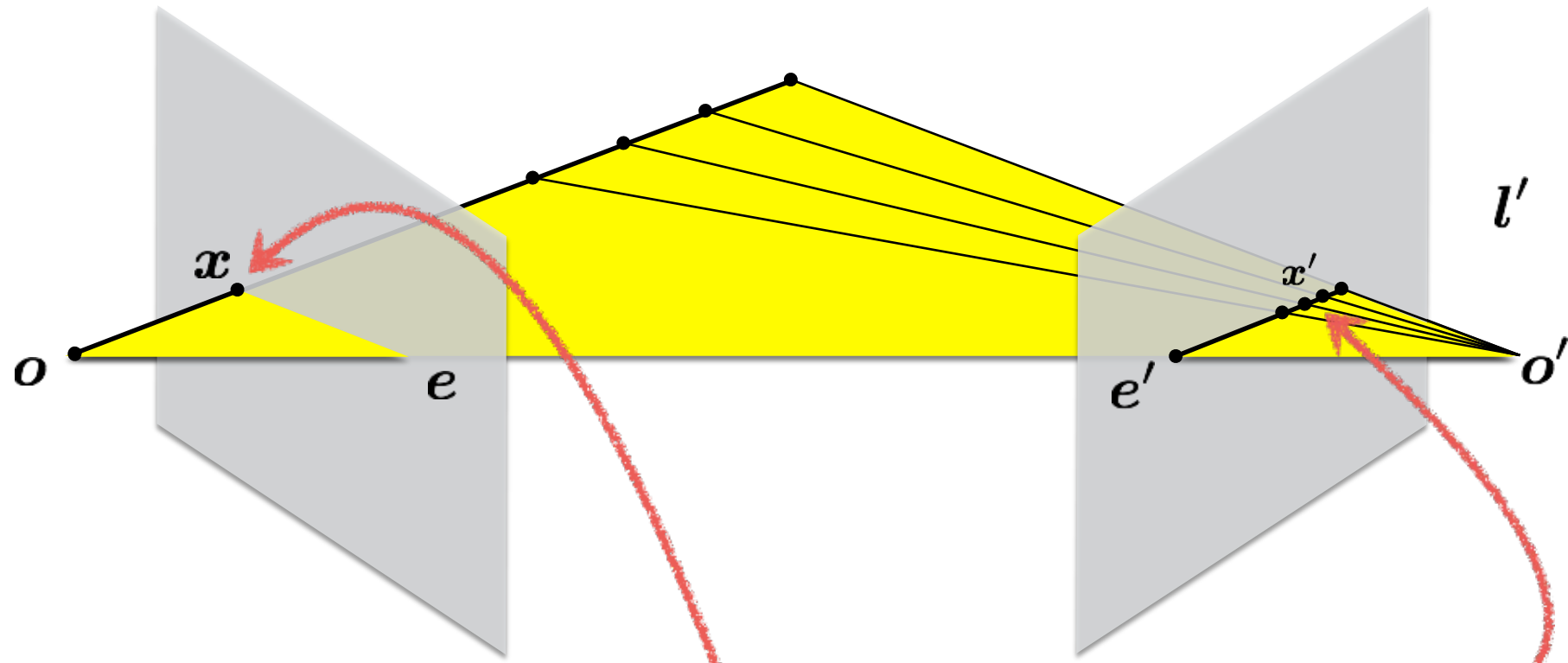

Potential matches for  $x$  lie on the epipolar line  $l'$

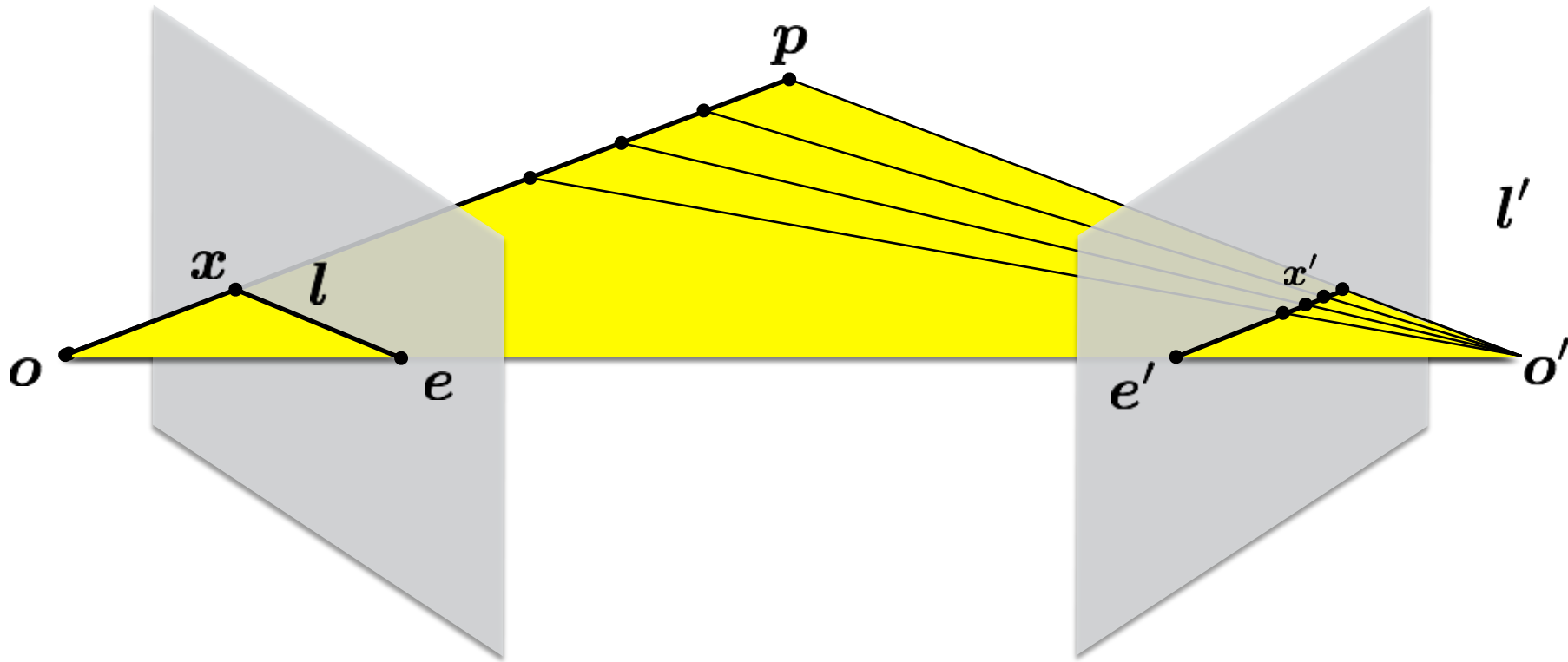

The point  $\mathbf{x}$  (left image) maps to a \_\_\_\_\_ in the right image

The baseline connects the \_\_\_\_\_ and \_\_\_\_\_

An epipolar line (left image) maps to a \_\_\_\_\_ in the right image

An epipole  $\mathbf{e}$  is a projection of the \_\_\_\_\_ on the image plane

All epipolar lines in an image intersect at the \_\_\_\_\_

# Converging cameras

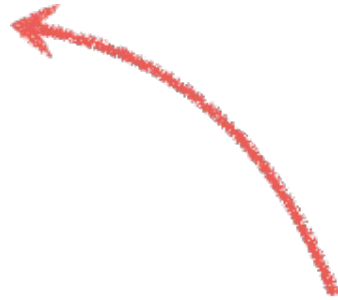
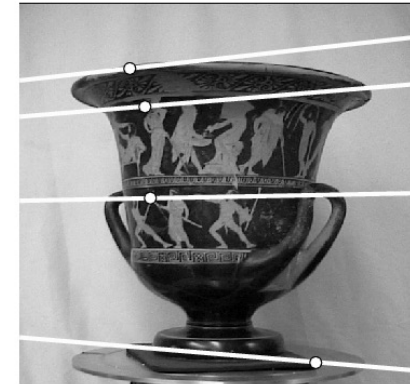
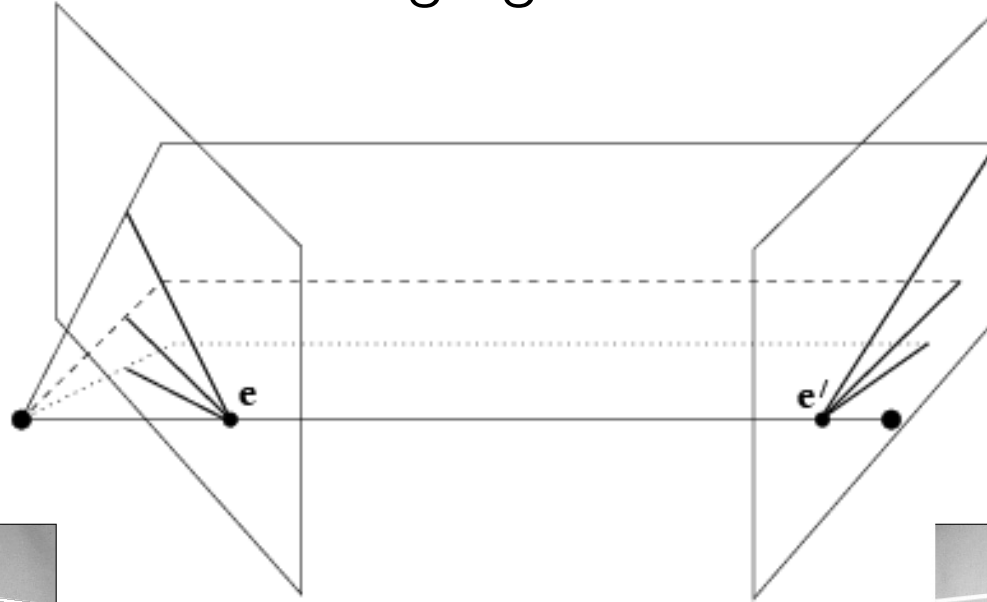

*Where is the epipole in this image?*

# Converging cameras

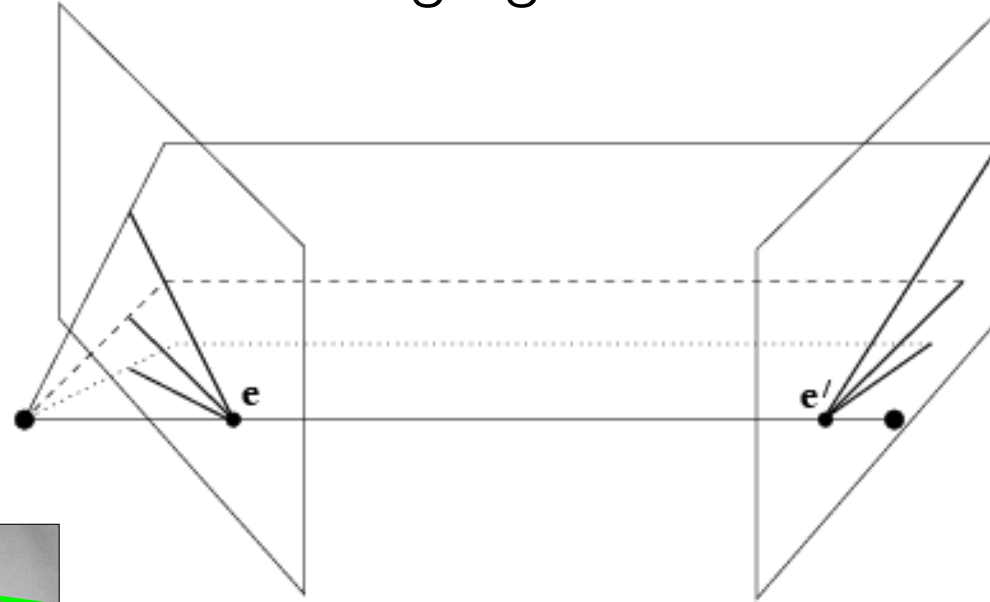

here!

*Where is the epipole in this image?*

It's not always in the image

# Parallel cameras

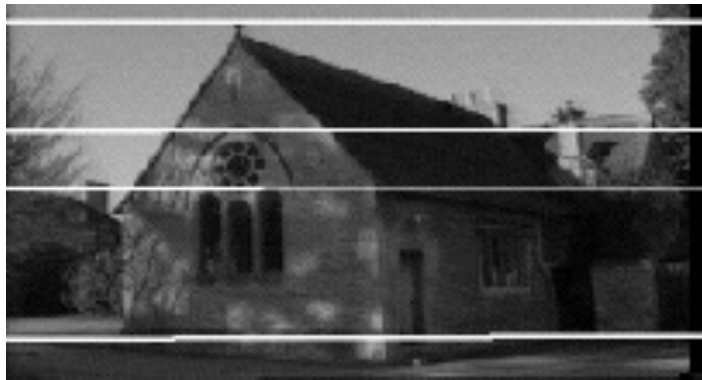
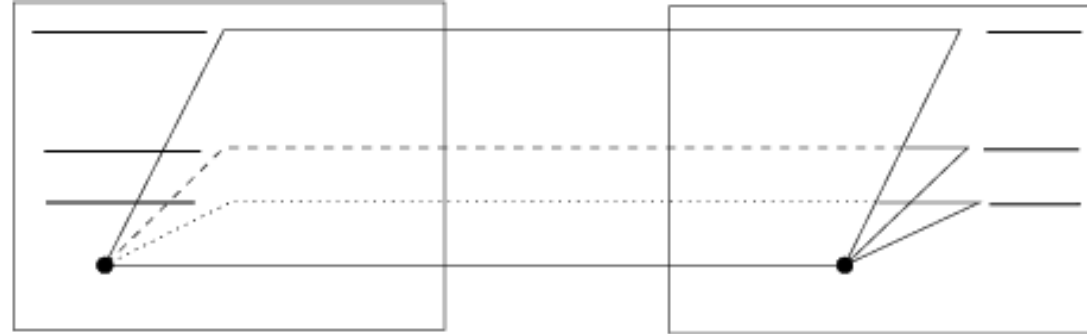

*Where is the epipole?*

# Parallel cameras

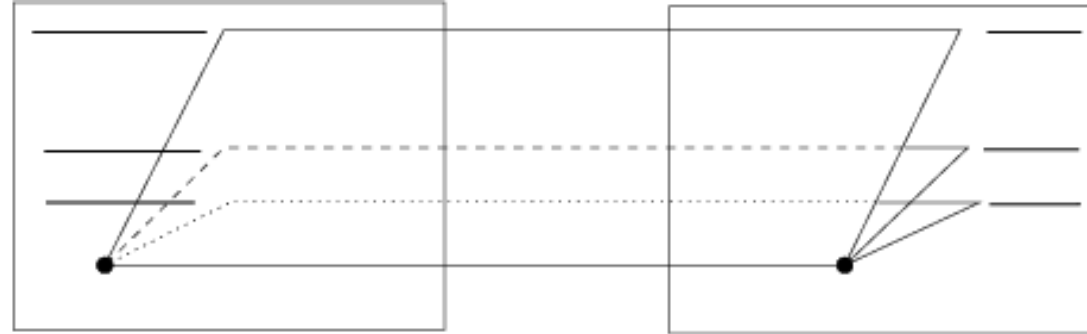

epipole at infinity

The epipolar constraint is an important concept for stereo vision

**Task:** Match point in left image to point in right image

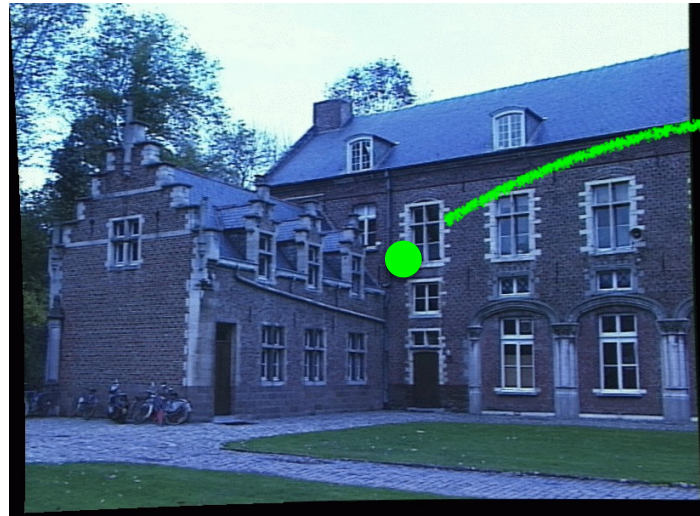

Left image

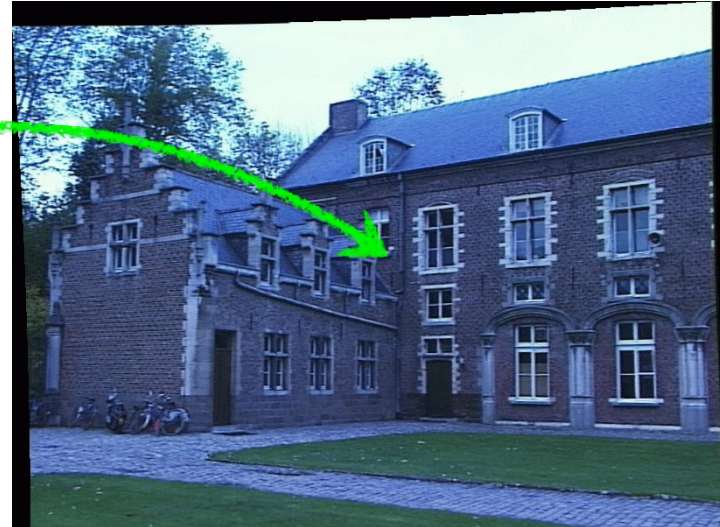

Right image

*How would you do it?*

# Epipolar constraint

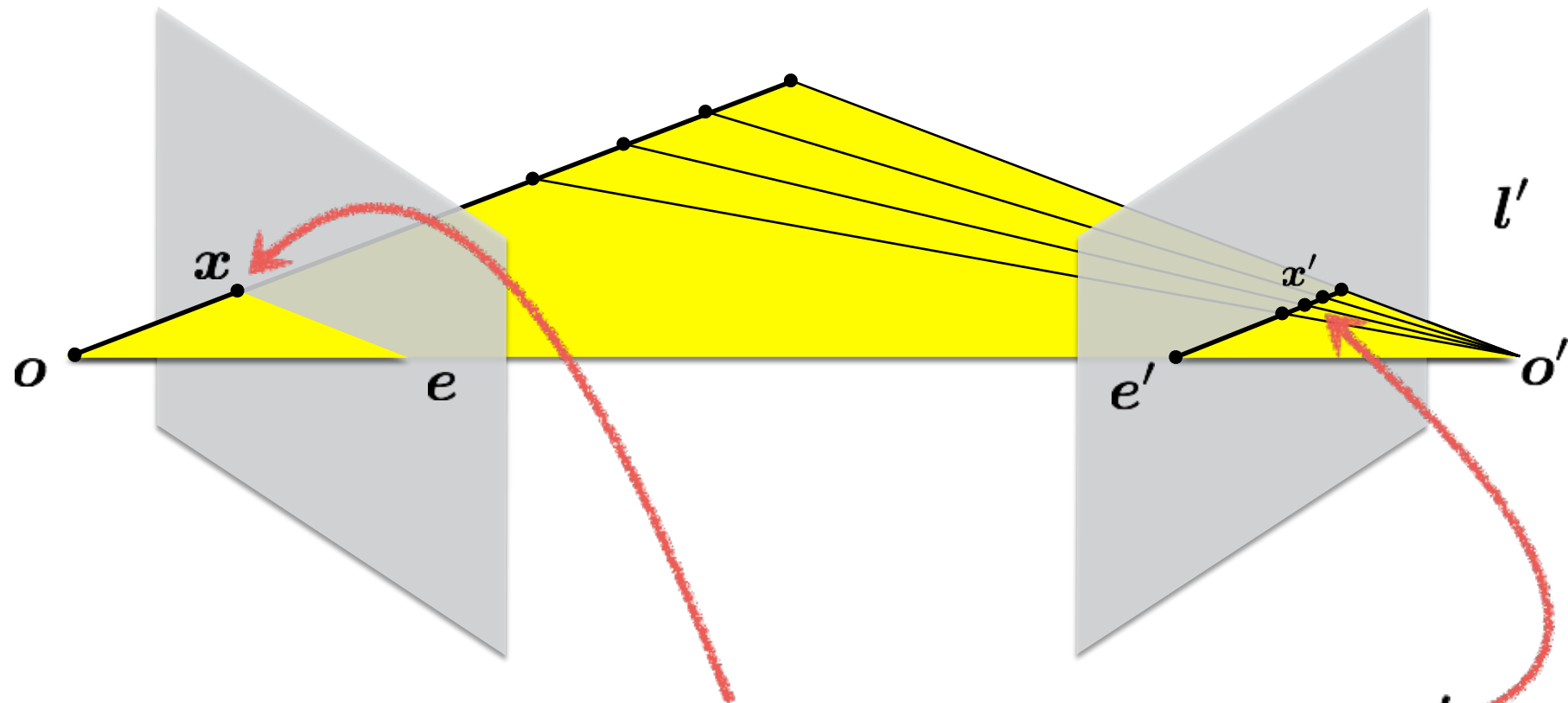

Potential matches for  $x$  lie on the epipolar line  $l'$



The epipolar constraint is an important concept for stereo vision

**Task:** Match point in left image to point in right image

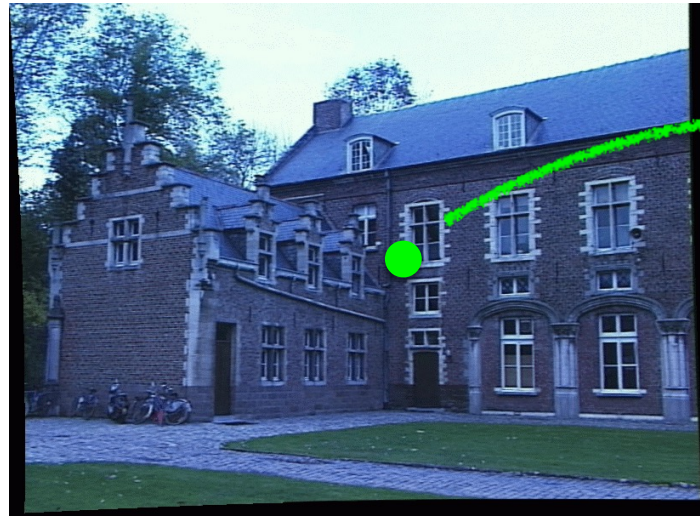

Left image

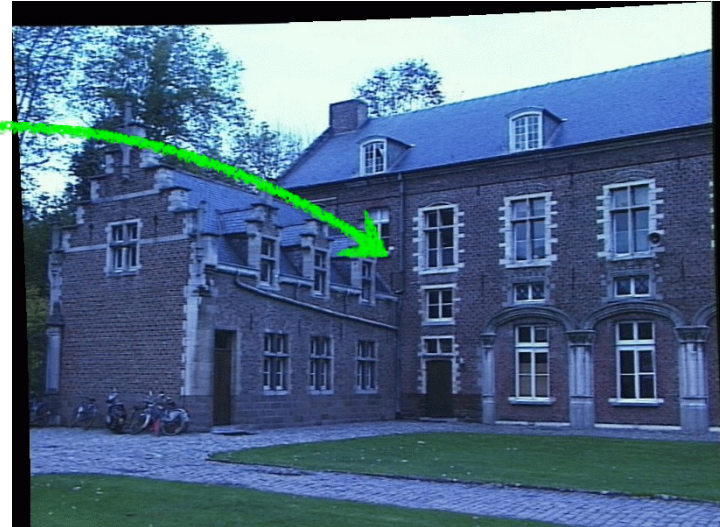

Right image

Want to avoid search over entire image

Epipolar constraint reduces search to a single line

The epipolar constraint is an important concept for stereo vision

**Task:** Match point in left image to point in right image

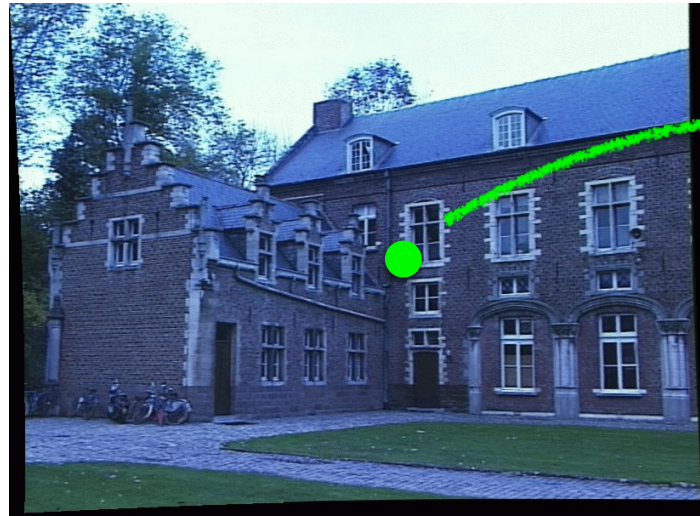

Left image

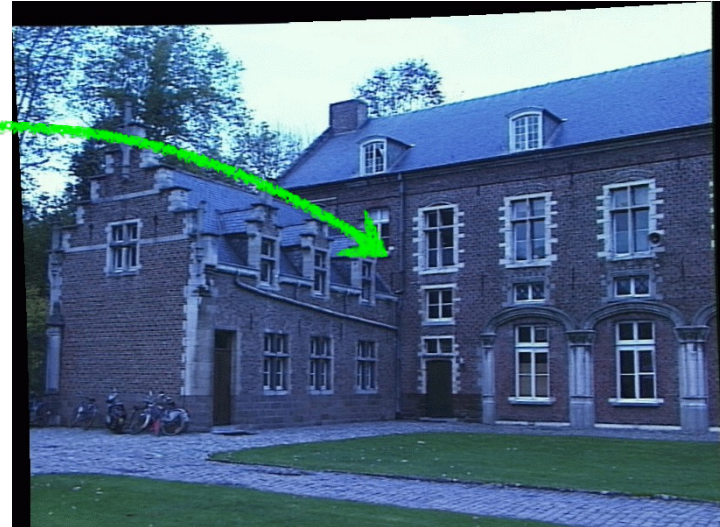

Right image

Want to avoid search over entire image

Epipolar constraint reduces search to a single line

*How do you compute the epipolar line?*

# The essential matrix

# Recall: Epipolar constraint

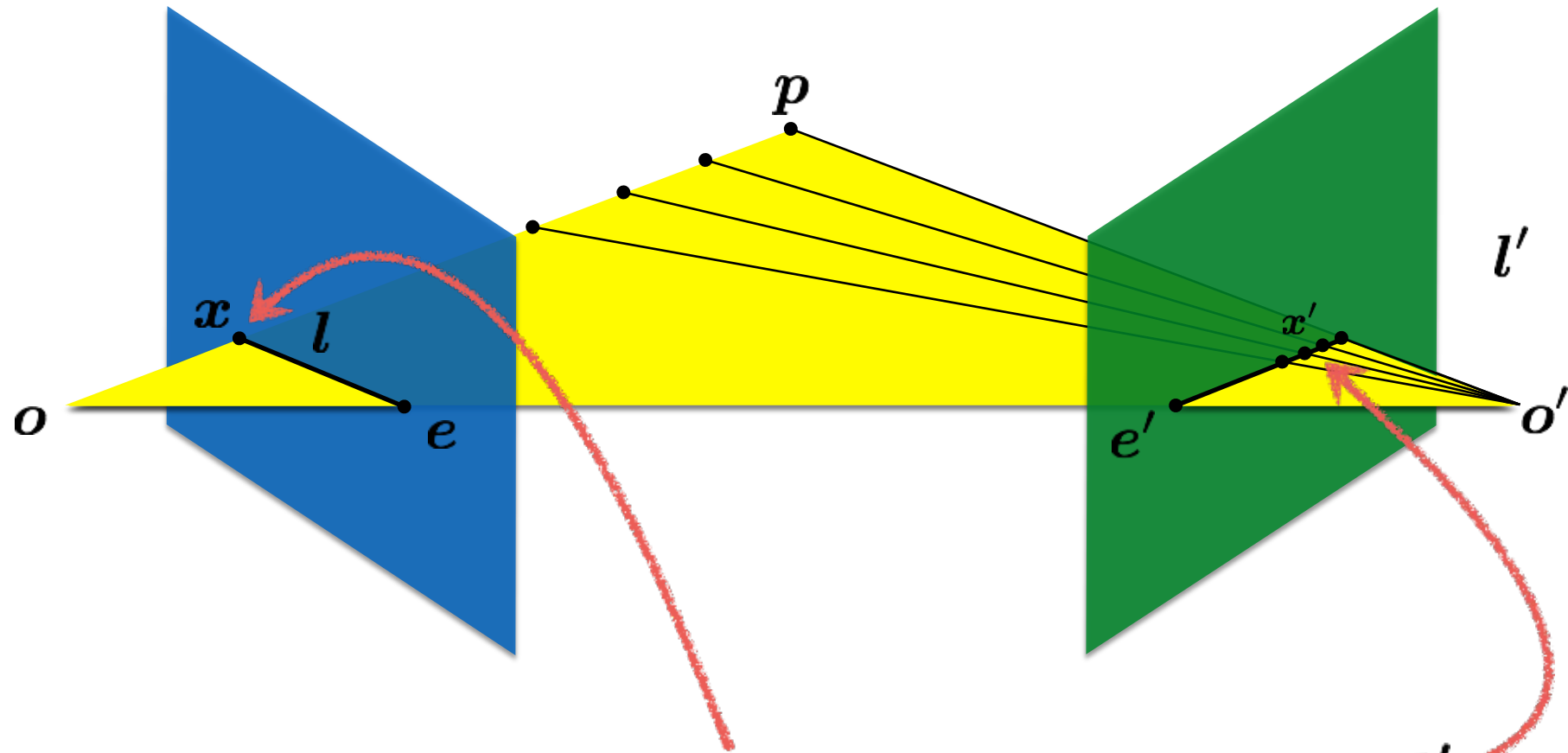

Potential matches for  $x$  lie on the epipolar line  $l'$

Given a point in one image, multiplying by the **essential matrix** will tell us the **epipolar line** in the second view.

$$Ex = l'$$

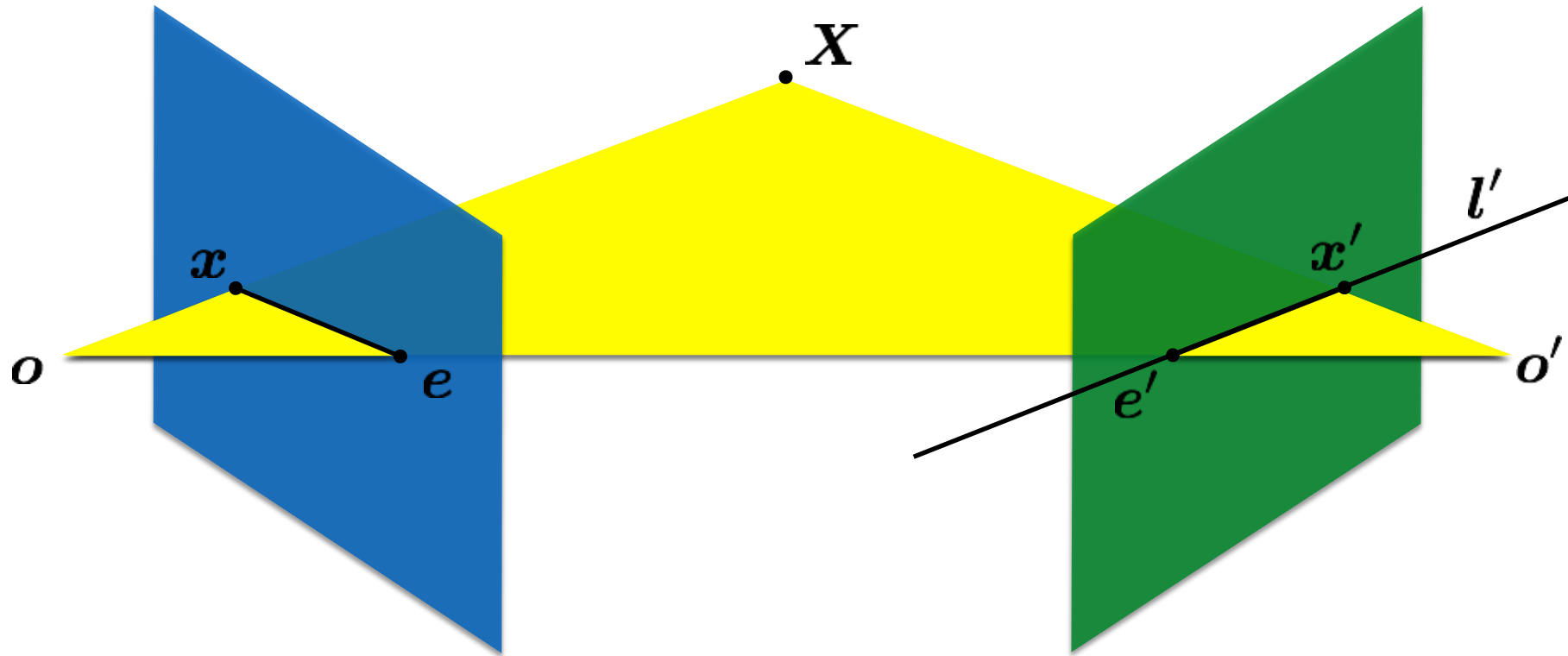

# Motivation

The Essential Matrix is a  $3 \times 3$  matrix that encodes **epipolar geometry**

Given a point in one image, multiplying by the **essential matrix** will tell us the **epipolar line** in the second image.

# Epipolar Line

$$ax + by + c = 0 \quad \text{in vector form} \quad \mathbf{l} = \begin{bmatrix} a \\ b \\ c \end{bmatrix}$$

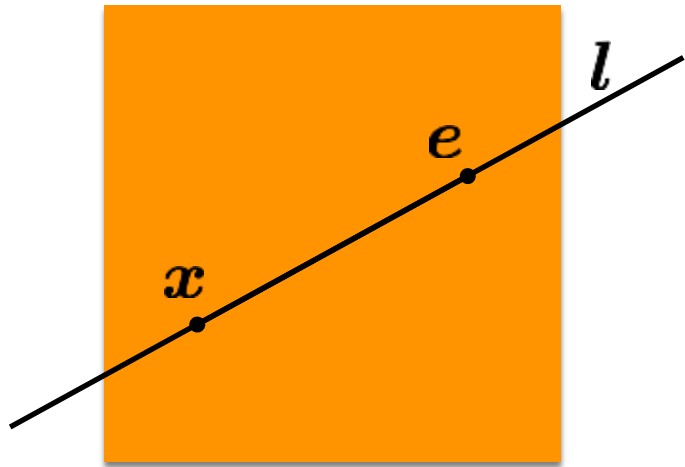

If the point  $\mathbf{x}$  is on the epipolar line  $\mathbf{l}$  then

$$\mathbf{x}^\top \mathbf{l} = ?$$

# Epipolar Line

$$ax + by + c = 0 \quad \text{in vector form} \quad \mathbf{l} = \begin{bmatrix} a \\ b \\ c \end{bmatrix}$$

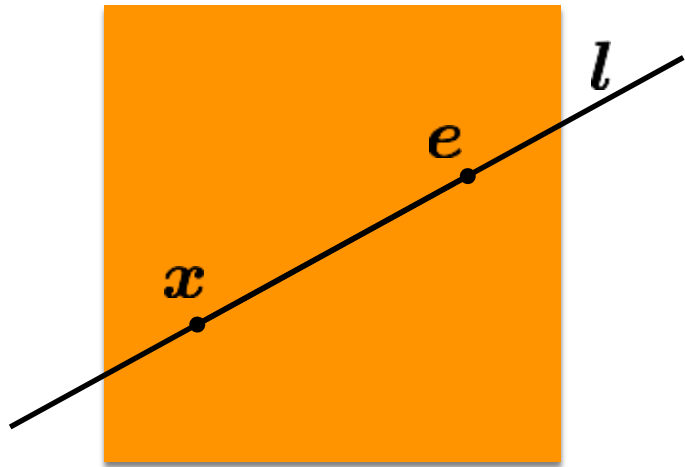

If the point  $\mathbf{x}$  is on the epipolar line  $\mathbf{l}$  then

$$\mathbf{x}^\top \mathbf{l} = 0$$



So if  $\mathbf{x}'^\top \mathbf{l}' = 0$  and  $\mathbf{E}\mathbf{x} = \mathbf{l}'$  then

$$\mathbf{x}'^\top \mathbf{E}\mathbf{x} = ?$$

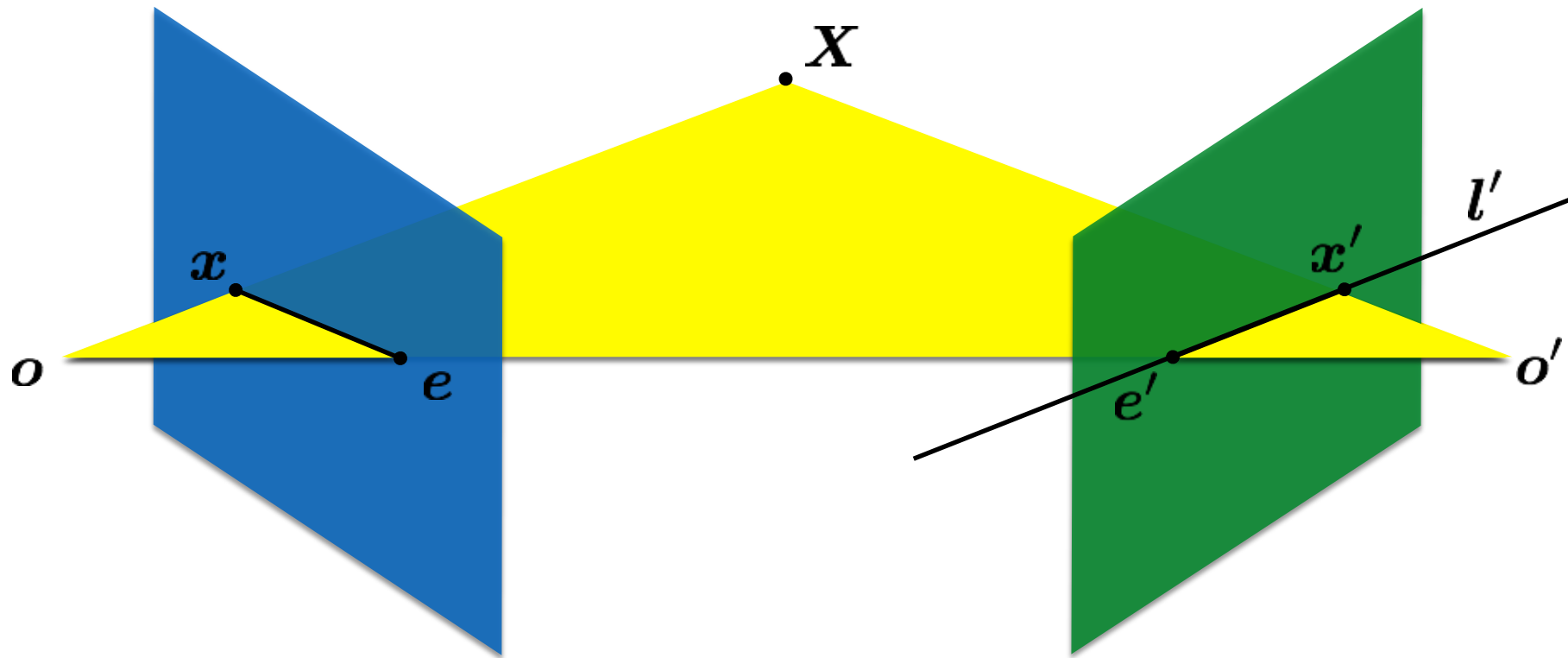

So if  $\mathbf{x}'^\top \mathbf{l}' = 0$  and  $\mathbf{E}\mathbf{x} = \mathbf{l}'$  then

$$\mathbf{x}'^\top \mathbf{E}\mathbf{x} = 0$$

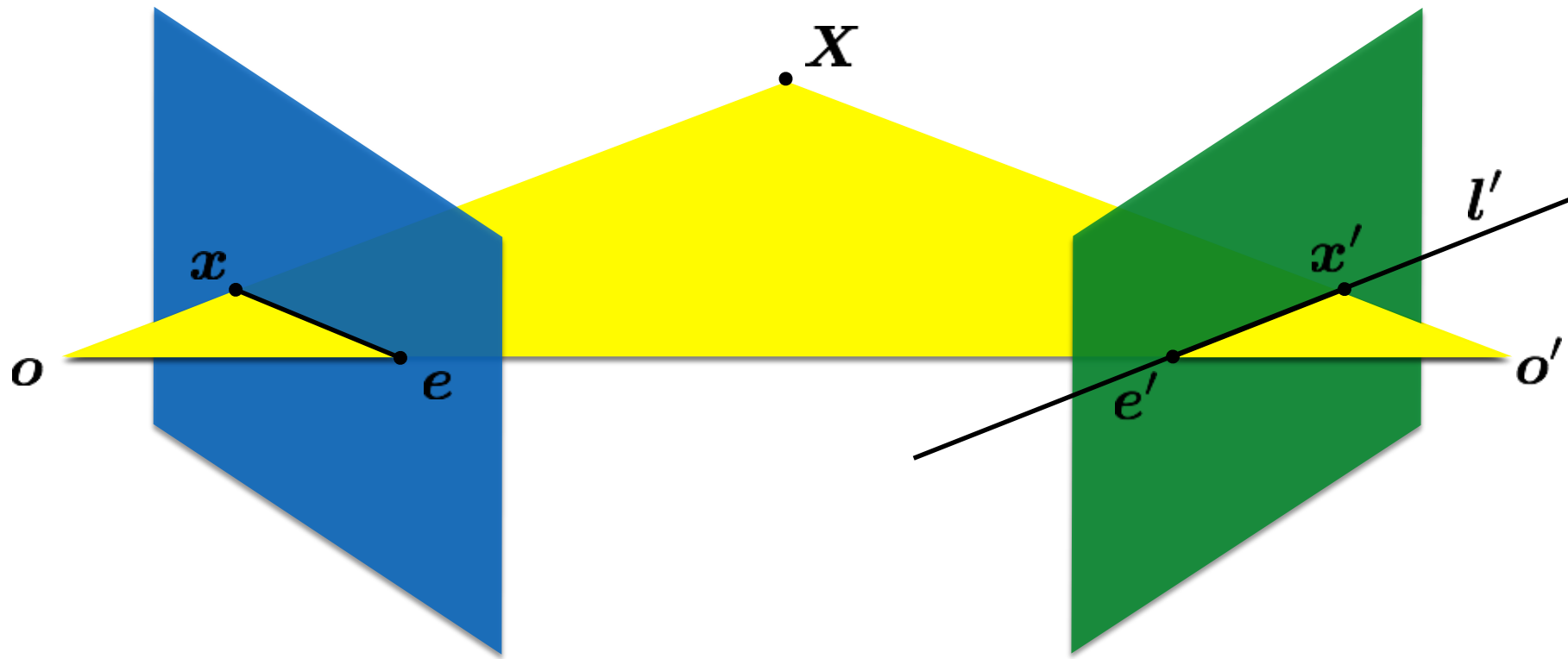

# Essential Matrix vs Homography

*What's the difference between the essential matrix and a homography?*

# Essential Matrix vs Homography

*What's the difference between the essential matrix and a homography?*

They are both 3 x 3 matrices but ...

$$l' = \mathbf{E}x$$

Essential matrix maps a  
**point** to a **line**

$$x' = \mathbf{H}x$$

Homography maps a  
**point** to a **point**

Where does the essential matrix come from?

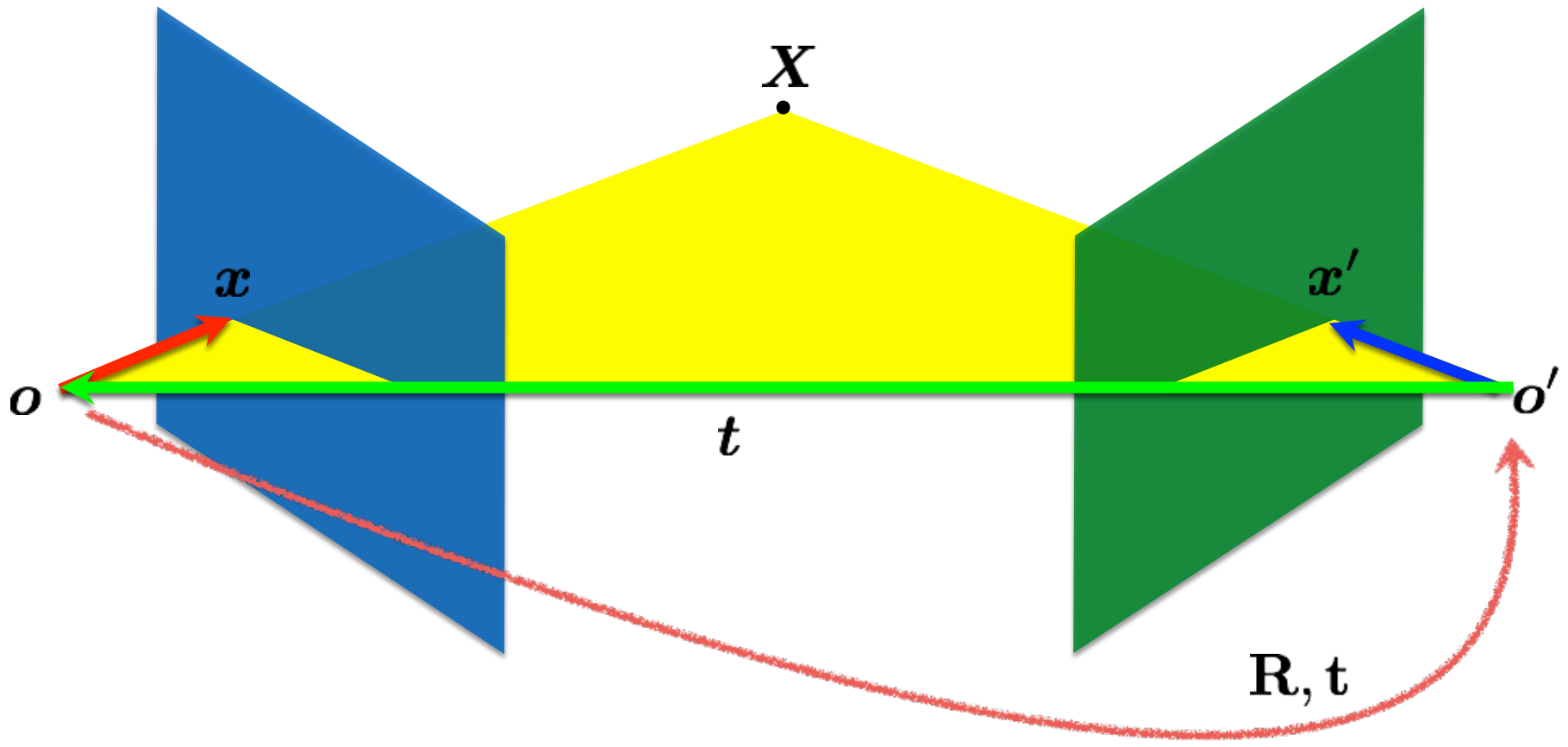

$$x' = \mathbf{R}(x - t)$$

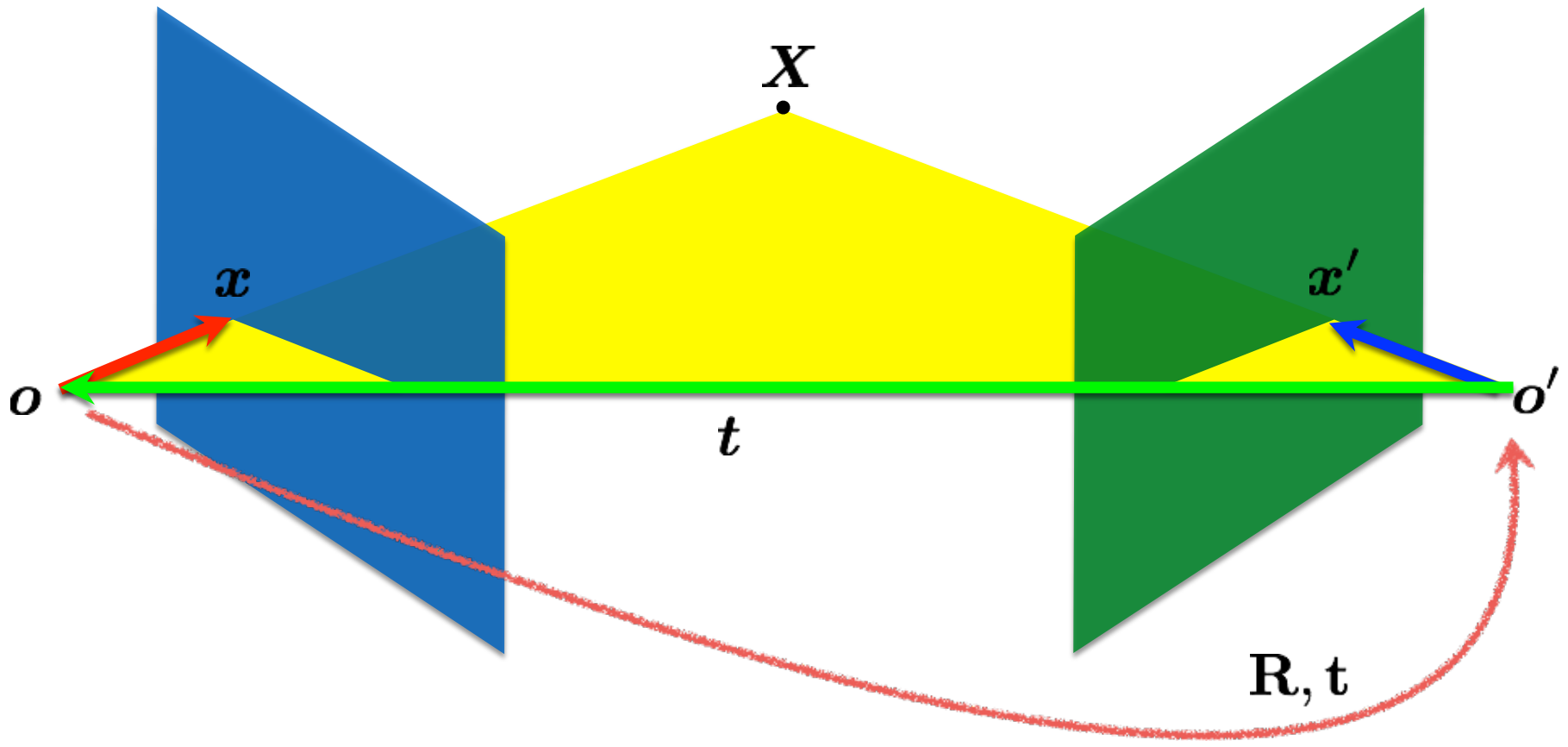

$$\mathbf{x}' = \mathbf{R}(\mathbf{x} - \mathbf{t})$$

*Does this look familiar?*

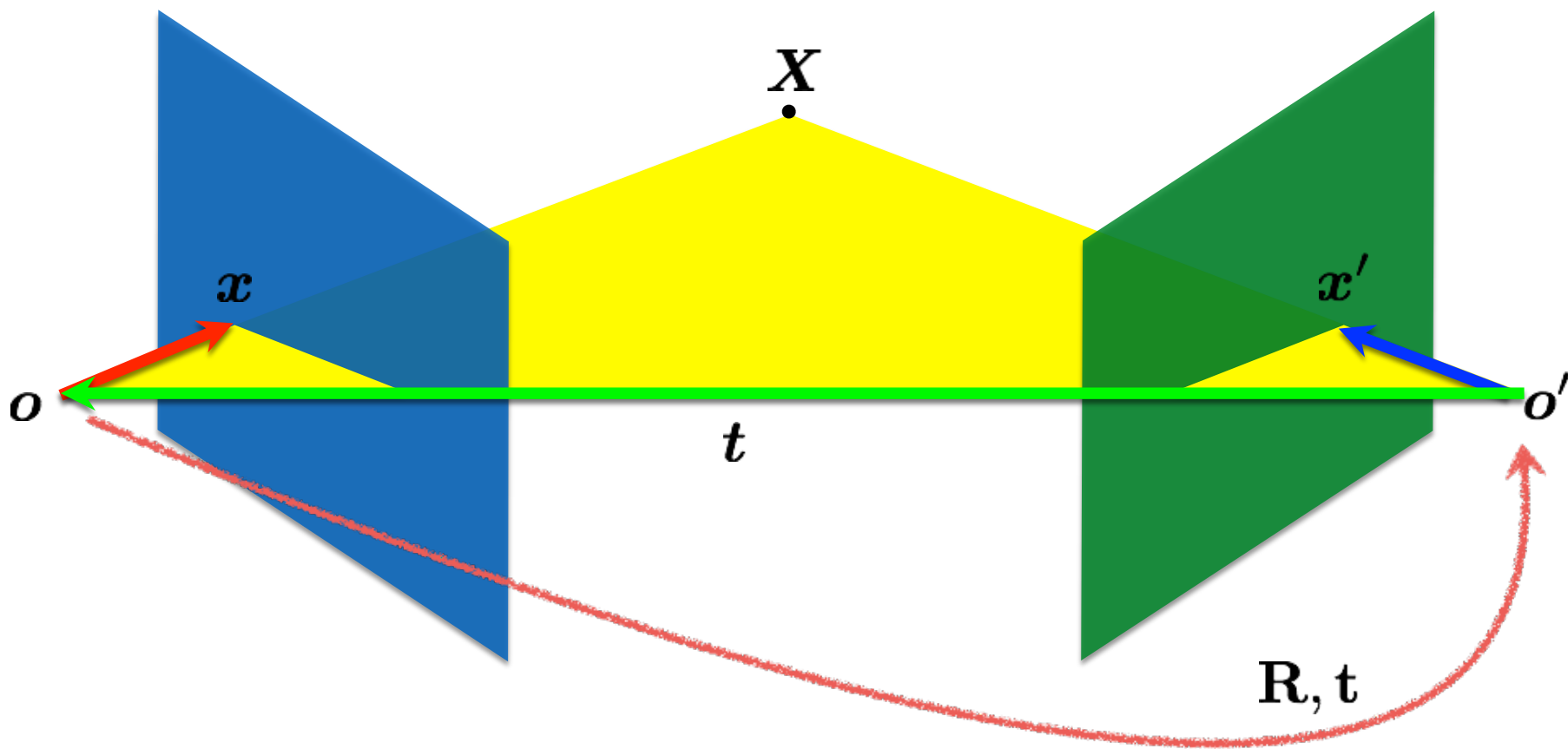

$$x' = \mathbf{R}(x - t)$$

**Camera-camera** transform just like **world-camera** transform



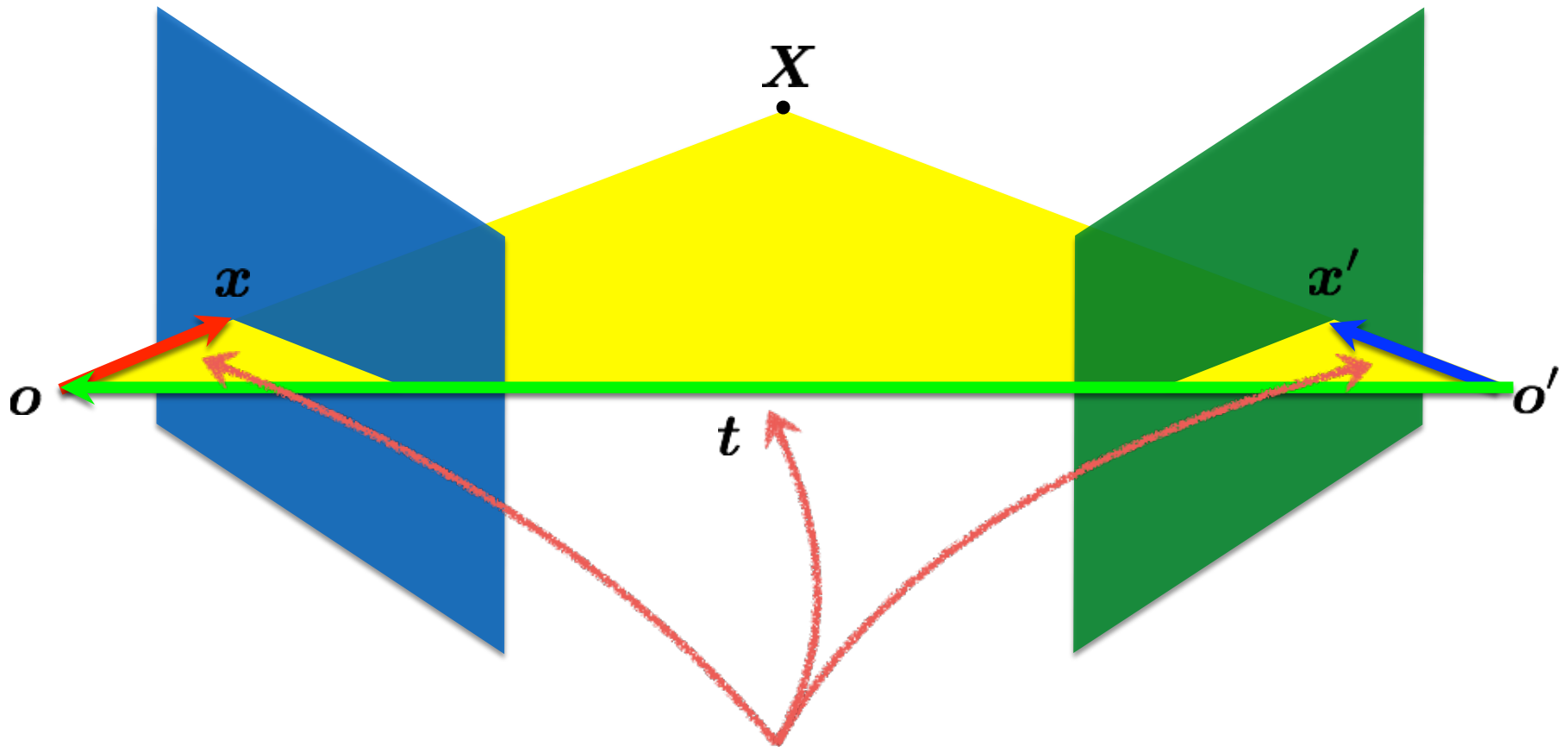

These three vectors are coplanar

$$\mathbf{x}, \mathbf{t}, \mathbf{x}'$$

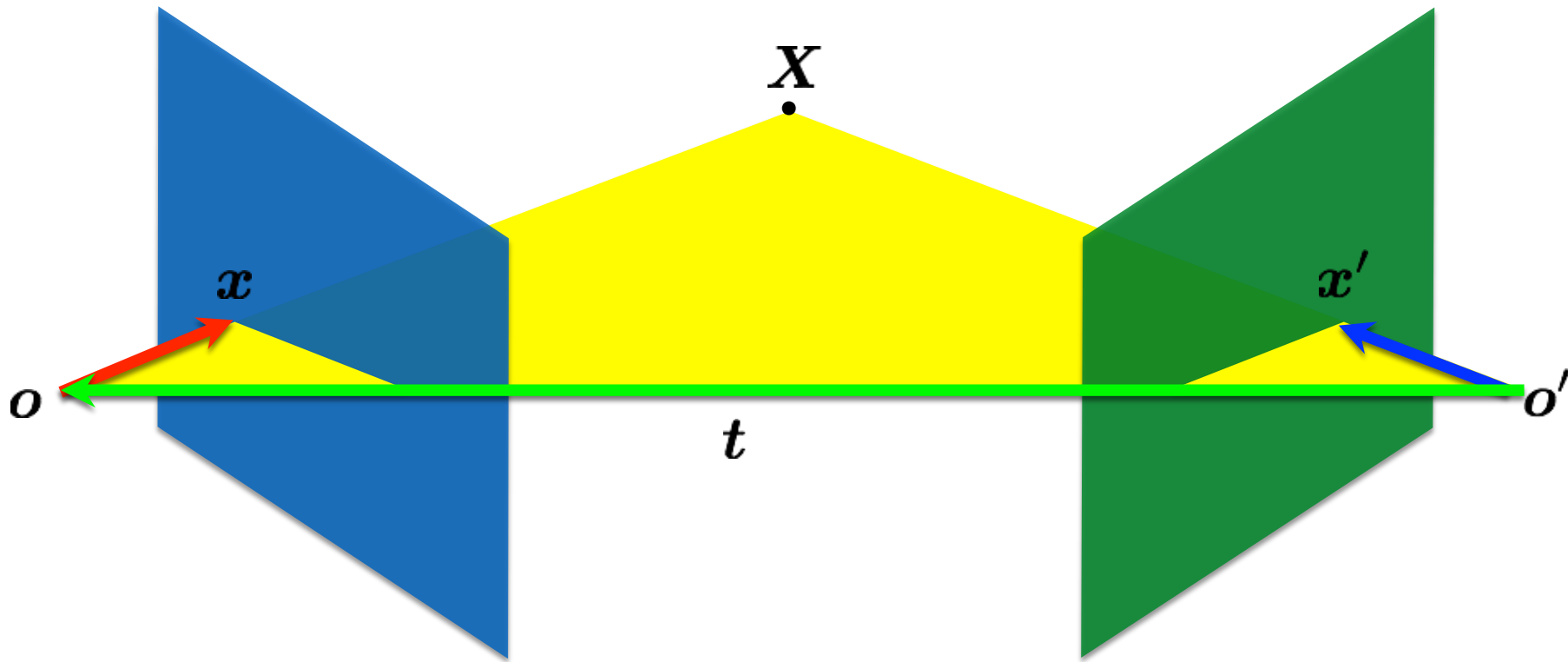

If these three vectors are coplanar  $\mathbf{x}, \mathbf{t}, \mathbf{x}'$  then

$$\mathbf{x}^\top (\mathbf{t} \times \mathbf{x}) = ?$$

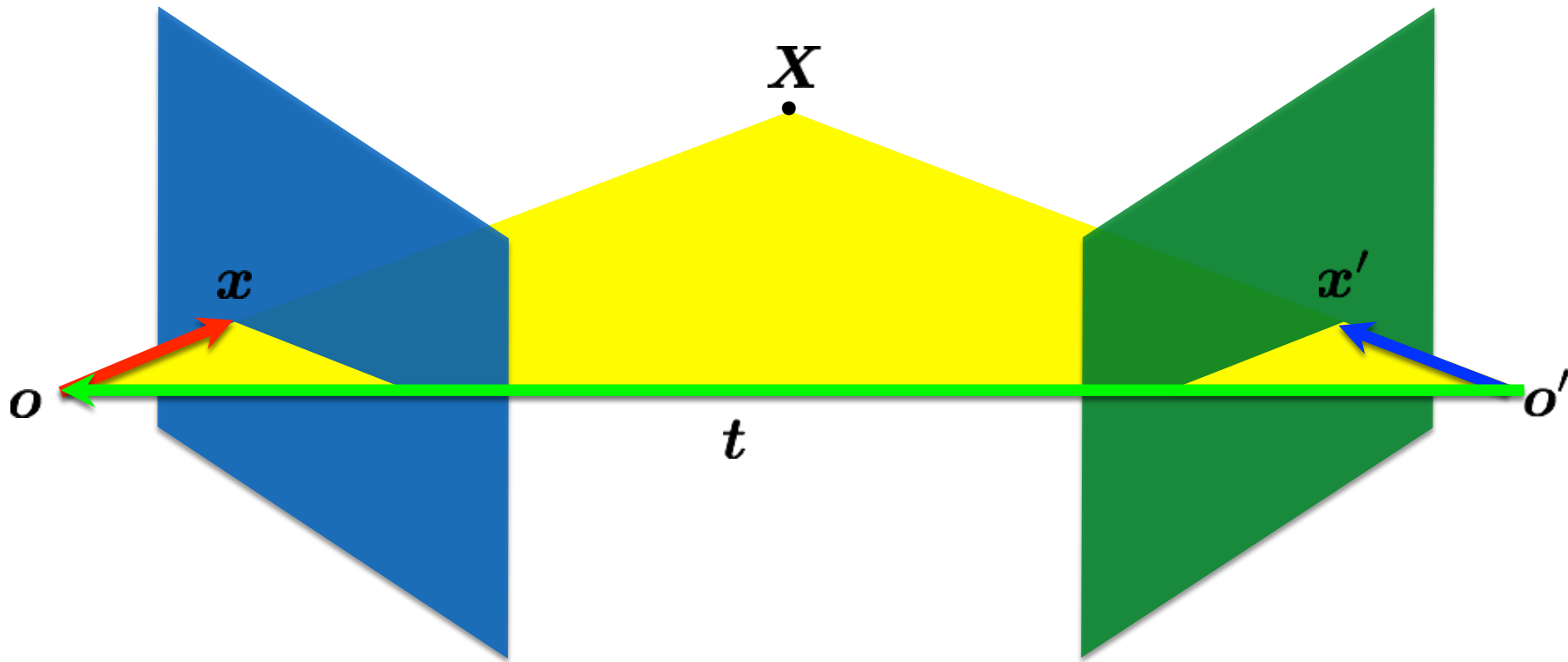

If these three vectors are coplanar  $\mathbf{x}, \mathbf{t}, \mathbf{x}'$  then

$$\mathbf{x}^\top (\mathbf{t} \times \mathbf{x}) = 0$$

dot product of orthogonal vectors

cross-product: vector orthogonal to plane

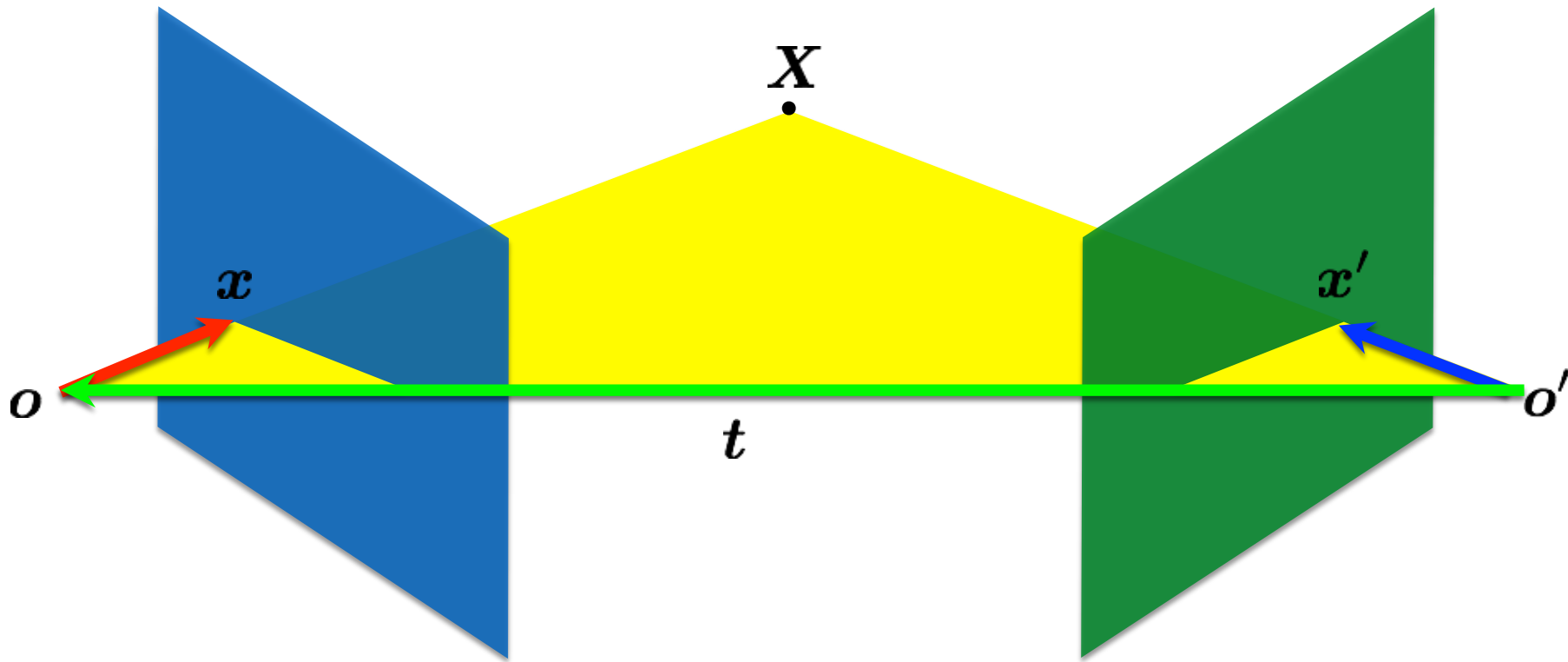

If these three vectors are coplanar  $\mathbf{x}, \mathbf{t}, \mathbf{x}'$  then

$$(\mathbf{x} - \mathbf{t})^\top (\mathbf{t} \times \mathbf{x}) = ?$$

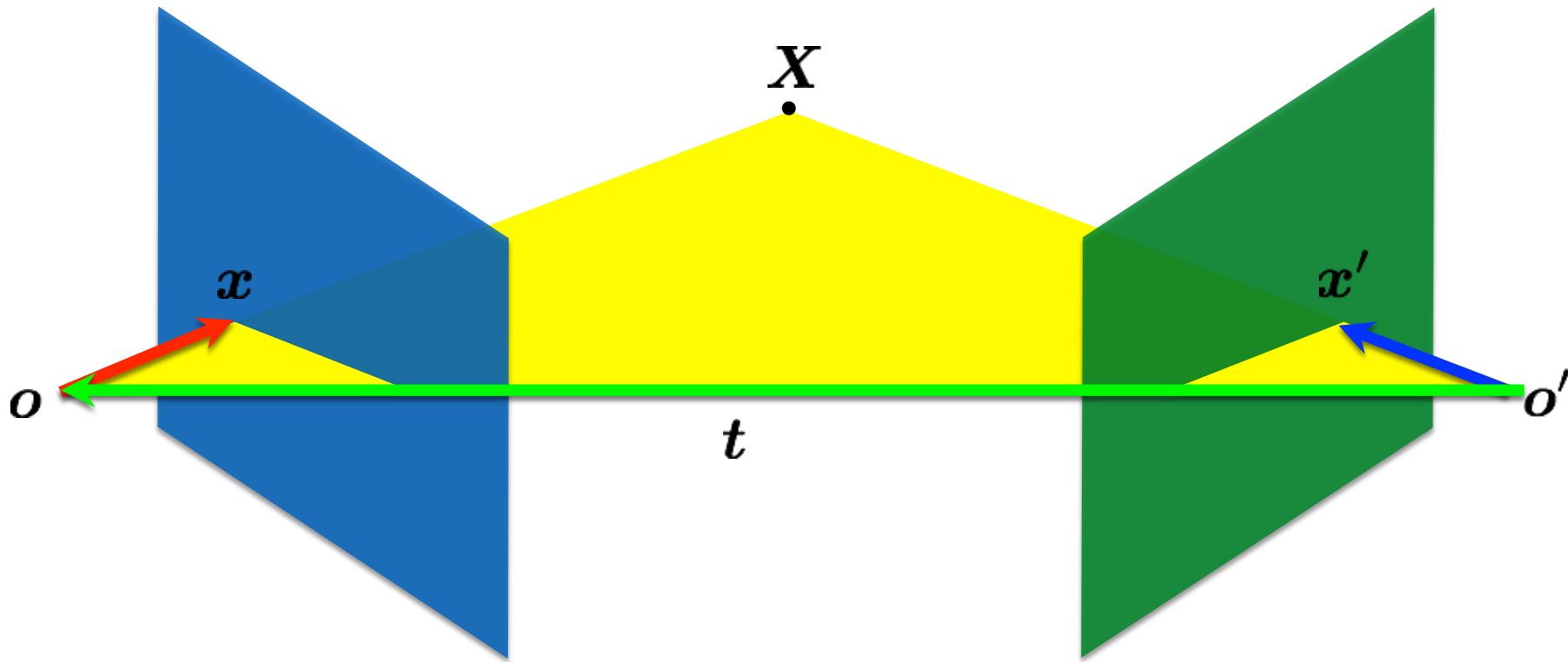

If these three vectors are coplanar  $\mathbf{x}, \mathbf{t}, \mathbf{x}'$  then

$$(\mathbf{x} - \mathbf{t})^\top (\mathbf{t} \times \mathbf{x}) = 0$$

# putting it together

rigid motion

$$\mathbf{x}' = \mathbf{R}(\mathbf{x} - \mathbf{t})$$

coplanarity

$$(\mathbf{x} - \mathbf{t})^\top (\mathbf{t} \times \mathbf{x}) = 0$$

$$(\mathbf{x}'^\top \mathbf{R})(\mathbf{t} \times \mathbf{x}) = 0$$

# Linear algebra reminder: cross product

Cross product

$$\mathbf{a} \times \mathbf{b} = \begin{bmatrix} a_2 b_3 - a_3 b_2 \\ a_3 b_1 - a_1 b_3 \\ a_1 b_2 - a_2 b_1 \end{bmatrix}$$

Can also be written as a matrix multiplication

$$\mathbf{a} \times \mathbf{b} = [\mathbf{a}]_{\times} \mathbf{b} = \begin{bmatrix} 0 & -a_3 & a_2 \\ a_3 & 0 & -a_1 \\ -a_2 & a_1 & 0 \end{bmatrix} \begin{bmatrix} b_1 \\ b_2 \\ b_3 \end{bmatrix}$$

**Skew symmetric**

# putting it together

rigid motion

$$\mathbf{x}' = \mathbf{R}(\mathbf{x} - \mathbf{t})$$

coplanarity

$$(\mathbf{x} - \mathbf{t})^\top (\mathbf{t} \times \mathbf{x}) = 0$$

use skew-symmetric  
matrix to represent cross  
product

$$(\mathbf{x}'^\top \mathbf{R})(\mathbf{t} \times \mathbf{x}) = 0$$

$$(\mathbf{x}'^\top \mathbf{R})([\mathbf{t}_\times] \mathbf{x}) = 0$$



# putting it together

rigid motion

$$\mathbf{x}' = \mathbf{R}(\mathbf{x} - \mathbf{t})$$

coplanarity

$$(\mathbf{x} - \mathbf{t})^\top (\mathbf{t} \times \mathbf{x}) = 0$$

$$(\mathbf{x}'^\top \mathbf{R})(\mathbf{t} \times \mathbf{x}) = 0$$

$$(\mathbf{x}'^\top \mathbf{R})([\mathbf{t}_\times] \mathbf{x}) = 0$$

$$\mathbf{x}'^\top (\mathbf{R}[\mathbf{t}_\times]) \mathbf{x} = 0$$

# putting it together

rigid motion

$$\mathbf{x}' = \mathbf{R}(\mathbf{x} - \mathbf{t})$$

coplanarity

$$(\mathbf{x} - \mathbf{t})^\top (\mathbf{t} \times \mathbf{x}) = 0$$

$$(\mathbf{x}'^\top \mathbf{R})(\mathbf{t} \times \mathbf{x}) = 0$$

$$(\mathbf{x}'^\top \mathbf{R})([\mathbf{t}_\times] \mathbf{x}) = 0$$

$$\mathbf{x}'^\top (\mathbf{R}[\mathbf{t}_\times]) \mathbf{x} = 0$$

$$\mathbf{x}'^\top \mathbf{E} \mathbf{x} = 0$$

# putting it together

rigid motion

$$\mathbf{x}' = \mathbf{R}(\mathbf{x} - \mathbf{t})$$

coplanarity

$$(\mathbf{x} - \mathbf{t})^\top (\mathbf{t} \times \mathbf{x}) = 0$$

$$(\mathbf{x}'^\top \mathbf{R})(\mathbf{t} \times \mathbf{x}) = 0$$

$$(\mathbf{x}'^\top \mathbf{R})([\mathbf{t}_\times] \mathbf{x}) = 0$$

$$\mathbf{x}'^\top (\mathbf{R}[\mathbf{t}_\times]) \mathbf{x} = 0$$

$$\mathbf{x}'^\top \mathbf{E} \mathbf{x} = 0$$

**Essential Matrix**

[Longuet-Higgins 1981]

# properties of the E matrix

Longuet-Higgins equation

$$\mathbf{x}'^T \mathbf{E} \mathbf{x} = 0$$

(2D points expressed in camera coordinate system)

# properties of the $\mathbf{E}$ matrix

Longuet-Higgins equation

$$\mathbf{x}'^{\top} \mathbf{E} \mathbf{x} = 0$$

Epipolar lines

$$\mathbf{x}^{\top} \mathbf{l} = 0$$

$$\mathbf{l}' = \mathbf{E} \mathbf{x}$$

$$\mathbf{x}'^{\top} \mathbf{l}' = 0$$

$$\mathbf{l} = \mathbf{E}^{\top} \mathbf{x}'$$

(2D points expressed in camera coordinate system)

# properties of the E matrix

Longuet-Higgins equation

$$\mathbf{x}'^{\top} \mathbf{E} \mathbf{x} = 0$$

Epipolar lines

$$\mathbf{x}^{\top} \mathbf{l} = 0$$

$$\mathbf{x}'^{\top} \mathbf{l}' = 0$$

$$\mathbf{l}' = \mathbf{E} \mathbf{x}$$

$$\mathbf{l} = \mathbf{E}^{\top} \mathbf{x}'$$

Epipoles

$$\mathbf{e}'^{\top} \mathbf{E} = \mathbf{0}$$

$$\mathbf{E} \mathbf{e} = \mathbf{0}$$

(2D points expressed in camera coordinate system)

Given a point in one image, multiplying by the **essential matrix** will tell us the **epipolar line** in the second view.

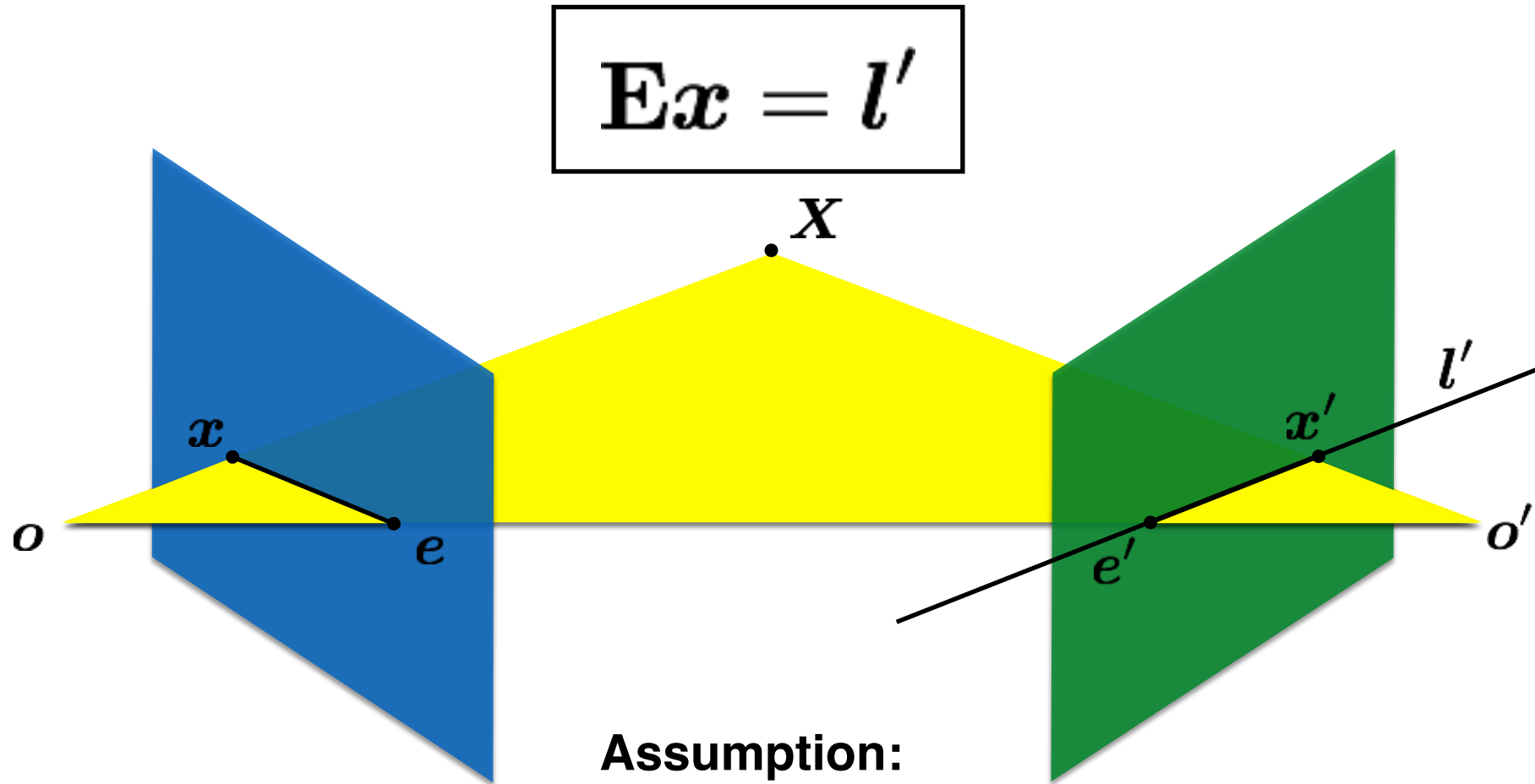

$$Ex = l'$$

**Assumption:**

2D points expressed in camera coordinate system (i.e., intrinsic matrices are identities)

How do you generalize  
to non-identity intrinsic  
matrices?



# The fundamental matrix

The  
**fundamental matrix**  
is a  
**generalization**  
of the  
**essential matrix,**  
where the assumption of  
**Identity matrices**  
is removed

$$\hat{\mathbf{x}}'^{\top} \mathbf{E} \hat{\mathbf{x}} = 0$$

The essential matrix operates on image points expressed in **2D coordinates** expressed in the camera coordinate system

$$\hat{\mathbf{x}}' = \mathbf{K}'^{-1} \mathbf{x}'$$

$$\hat{\mathbf{x}} = \mathbf{K}^{-1} \mathbf{x}$$

camera point                      image point

$$\hat{\mathbf{x}}'^{\top} \mathbf{E} \hat{\mathbf{x}} = 0$$

The essential matrix operates on image points expressed in **2D coordinates** expressed in the camera coordinate system

$$\hat{\mathbf{x}}' = \mathbf{K}'^{-1} \mathbf{x}'$$

$$\hat{\mathbf{x}} = \mathbf{K}^{-1} \mathbf{x}$$

camera point                      image point

Writing out the epipolar constraint in terms of image coordinates

$$\mathbf{K}'^{-\top} \mathbf{E} \mathbf{K}^{-1} \mathbf{x} = 0$$
$$\mathbf{x}'^{\top} (\mathbf{K}'^{-\top} \mathbf{E} \mathbf{K}^{-1}) \mathbf{x} = 0$$
$$\mathbf{x}'^{\top} \mathbf{F} \mathbf{x} = 0$$

Same equation works in image coordinates!

$$\mathbf{x}'^T \mathbf{F} \mathbf{x} = 0$$

it maps pixels to epipolar lines

# properties of the $\mathbf{E}$ matrix

Longuet-Higgins equation

$$\mathbf{x}'^T \mathbf{E} \mathbf{x} = 0$$

Epipolar lines

$$\mathbf{x}^T \mathbf{l} = 0$$

$$\mathbf{x}'^T \mathbf{l}' = 0$$

$$\mathbf{l}' = \mathbf{E} \mathbf{x}$$

$$\mathbf{l} = \mathbf{E}^T \mathbf{x}'$$

Epipoles

$$\mathbf{e}'^T \mathbf{E} = \mathbf{0}$$

$$\mathbf{E} \mathbf{e} = \mathbf{0}$$

(points in **image** coordinates)

Breaking down the fundamental matrix

$$\mathbf{F} = \mathbf{K}'^{-\top} \mathbf{E} \mathbf{K}^{-1}$$

$$\mathbf{F} = \mathbf{K}'^{-\top} [\mathbf{t}_x] \mathbf{R} \mathbf{K}^{-1}$$

Depends on both intrinsic and extrinsic parameters

Breaking down the fundamental matrix

$$\mathbf{F} = \mathbf{K}'^{-\top} \mathbf{E} \mathbf{K}^{-1}$$

$$\mathbf{F} = \mathbf{K}'^{-\top} [\mathbf{t}_x] \mathbf{R} \mathbf{K}^{-1}$$

Depends on both intrinsic and extrinsic parameters

*How would you solve for F?*

$$\mathbf{x}'^{\top} \mathbf{F} \mathbf{x}_m = 0$$



# The 8-point algorithm

Assume you have  $M$  matched *image* points

$$\{\mathbf{x}_m, \mathbf{x}'_m\} \quad m = 1, \dots, M$$

Each correspondence should satisfy

$$\mathbf{x}'_m{}^\top \mathbf{F} \mathbf{x}_m = 0$$

*How would you solve for the 3 x 3  $\mathbf{F}$  matrix?*

Assume you have  $M$  matched *image* points

$$\{\mathbf{x}_m, \mathbf{x}'_m\} \quad m = 1, \dots, M$$

Each correspondence should satisfy

$$\mathbf{x}'_m{}^\top \mathbf{F} \mathbf{x}_m = 0$$

*How would you solve for the 3 x 3  $\mathbf{F}$  matrix?*

SVD!

Assume you have  $M$  matched *image* points

$$\{\mathbf{x}_m, \mathbf{x}'_m\} \quad m = 1, \dots, M$$

Each correspondence should satisfy

$$\mathbf{x}'_m{}^\top \mathbf{F} \mathbf{x}_m = 0$$

*How would you solve for the 3 x 3  $\mathbf{F}$  matrix?*

Set up a homogeneous linear system with 9 unknowns

$$\mathbf{x}'_m{}^\top \mathbf{F} \mathbf{x}_m = 0$$

$$\begin{bmatrix} x'_m & y'_m & 1 \end{bmatrix} \begin{bmatrix} f_1 & f_2 & f_3 \\ f_4 & f_5 & f_6 \\ f_7 & f_8 & f_9 \end{bmatrix} \begin{bmatrix} x_m \\ y_m \\ 1 \end{bmatrix} = 0$$

*How many equations do you get from one correspondence?*

$$\begin{bmatrix} x'_m & y'_m & 1 \end{bmatrix} \begin{bmatrix} f_1 & f_2 & f_3 \\ f_4 & f_5 & f_6 \\ f_7 & f_8 & f_9 \end{bmatrix} \begin{bmatrix} x_m \\ y_m \\ 1 \end{bmatrix} = 0$$

ONE correspondence gives you ONE equation

$$\begin{aligned} x_m x'_m f_1 + x_m y'_m f_2 + x_m f_3 + \\ y_m x'_m f_4 + y_m y'_m f_5 + y_m f_6 + \\ x'_m f_7 + y'_m f_8 + f_9 = 0 \end{aligned}$$

$$\begin{bmatrix} x'_m & y'_m & 1 \end{bmatrix} \begin{bmatrix} f_1 & f_2 & f_3 \\ f_4 & f_5 & f_6 \\ f_7 & f_8 & f_9 \end{bmatrix} \begin{bmatrix} x_m \\ y_m \\ 1 \end{bmatrix} = 0$$

Set up a homogeneous linear system with 9 unknowns

$$\begin{bmatrix} x_1 x'_1 & x_1 y'_1 & x_1 & y_1 x'_1 & y_1 y'_1 & y_1 & x'_1 & y'_1 & 1 \\ \vdots & \vdots & \vdots & \vdots & \vdots & \vdots & \vdots & \vdots & \vdots \\ x_M x'_M & x_M y'_M & x_M & y_M x'_M & y_M y'_M & y_M & x'_M & y'_M & 1 \end{bmatrix} \begin{bmatrix} f_1 \\ f_2 \\ f_3 \\ f_4 \\ f_5 \\ f_6 \\ f_7 \\ f_8 \\ f_9 \end{bmatrix} = \mathbf{0}$$

*How many equations do you need?*

Each point pair (according to epipolar constraint)  
contributes only one scalar equation

$$\mathbf{x}'_m{}^\top \mathbf{F} \mathbf{x}_m = 0$$

**Note:** This is different from the Homography estimation  
where each point pair contributes 2 equations.

We need at least 8 points

**Hence, the 8 point algorithm!**



*How do you solve a homogeneous linear system?*

$$\mathbf{A}\mathbf{X} = \mathbf{0}$$

*How do you solve a homogeneous linear system?*

$$\mathbf{A}\mathbf{X} = \mathbf{0}$$

**Total Least Squares**

minimize  $\|\mathbf{A}\mathbf{x}\|^2$

subject to  $\|\mathbf{x}\|^2 = 1$

*How do you solve a homogeneous linear system?*

$$\mathbf{A}\mathbf{X} = \mathbf{0}$$

**Total Least Squares**

minimize  $\|\mathbf{A}\mathbf{x}\|^2$

subject to  $\|\mathbf{x}\|^2 = 1$

**SVD!**

# Eight-Point Algorithm

0. (Normalize points)
1. Construct the  $M \times 9$  matrix  $\mathbf{A}$
2. Find the SVD of  $\mathbf{A}$
3. Entries of  $\mathbf{F}$  are the elements of column of  $\mathbf{V}$  corresponding to the least singular value
4. (Enforce rank 2 constraint on  $\mathbf{F}$ )
5. (Un-normalize  $\mathbf{F}$ )

# Eight-Point Algorithm

0. (Normalize points)

1. Construct the  $M \times 9$  matrix  $\mathbf{A}$

2. Find the SVD of  $\mathbf{A}$

3. Entries of  $\mathbf{F}$  are the elements of column of  $\mathbf{V}$  corresponding to the least singular value

4. (Enforce rank 2 constraint on  $\mathbf{F}$ )

5. (Un-normalize  $\mathbf{F}$ )

See Hartley-Zisserman for why we do this



# Eight-Point Algorithm

0. (Normalize points)

1. Construct the  $M \times 9$  matrix  $\mathbf{A}$

2. Find the SVD of  $\mathbf{A}$

3. Entries of  $\mathbf{F}$  are the elements of column of  $\mathbf{V}$  corresponding to the least singular value

4. (Enforce rank 2 constraint on  $\mathbf{F}$ )

5. (Un-normalize  $\mathbf{F}$ )

How do we do this?



# Eight-Point Algorithm

0. (Normalize points)

1. Construct the  $M \times 9$  matrix  $\mathbf{A}$

2. Find the SVD of  $\mathbf{A}$

3. Entries of  $\mathbf{F}$  are the elements of column of  $\mathbf{V}$  corresponding to the least singular value

4. (Enforce rank 2 constraint on  $\mathbf{F}$ )

5. (Un-normalize  $\mathbf{F}$ )

How do we do this?

**SVD!**

# Enforcing rank constraints

**Problem:** Given a matrix  $F$ , find the matrix  $F'$  of rank  $k$  that is closest to  $F$ ,

$$\min_{\substack{F' \\ \text{rank}(F')=k}} \|F - F'\|^2$$

**Solution:** Compute the singular value decomposition of  $F$ ,

$$F = U\Sigma V^T$$

Form a matrix  $\Sigma'$  by replacing all but the  $k$  largest singular values in  $\Sigma$  with 0.

Then the problem solution is the matrix  $F'$  formed as,

$$F' = U\Sigma'V^T$$



# Eight-Point Algorithm

0. (Normalize points)
1. Construct the  $M \times 9$  matrix  $\mathbf{A}$
2. Find the SVD of  $\mathbf{A}$
3. Entries of  $\mathbf{F}$  are the elements of column of  $\mathbf{V}$  corresponding to the least singular value
4. (Enforce rank 2 constraint on  $\mathbf{F}$ )
5. (Un-normalize  $\mathbf{F}$ )

# Example

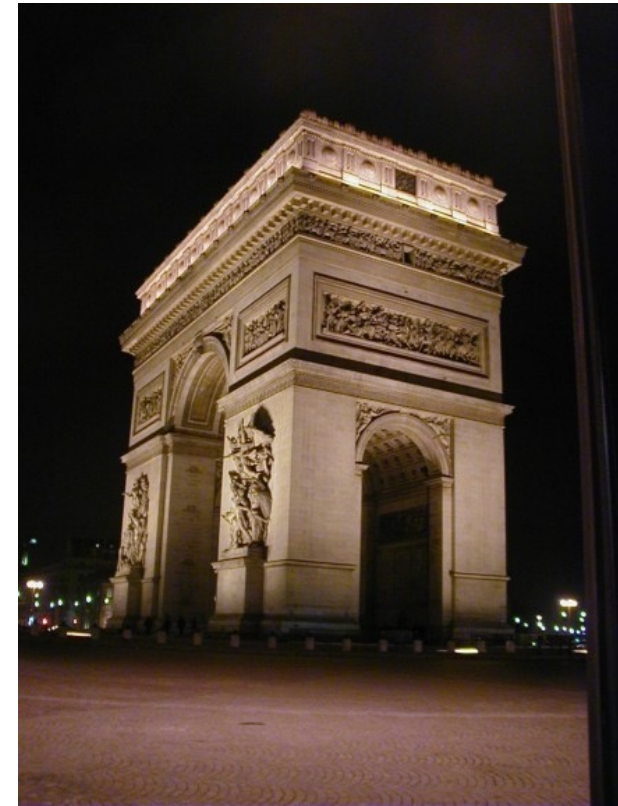

# epipolar lines



$$\mathbf{F} = \begin{bmatrix} -0.00310695 & -0.0025646 & 2.96584 \\ -0.028094 & -0.00771621 & 56.3813 \\ 13.1905 & -29.2007 & -9999.79 \end{bmatrix}$$

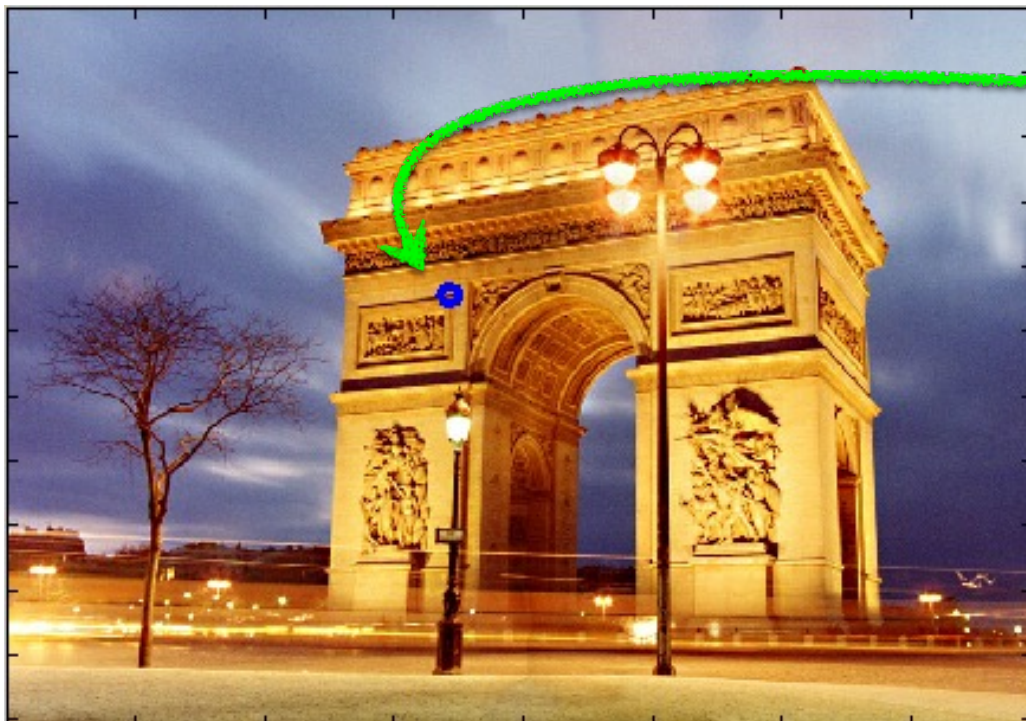

$$\mathbf{x} = \begin{bmatrix} 343.53 \\ 221.70 \\ 1.0 \end{bmatrix}$$

$$\begin{aligned} \mathbf{l}' &= \mathbf{F}\mathbf{x} \\ &= \begin{bmatrix} 0.0295 \\ 0.9996 \\ -265.1531 \end{bmatrix} \end{aligned}$$

$$l' = \mathbf{F}x$$

$$= \begin{bmatrix} 0.0295 \\ 0.9996 \\ -265.1531 \end{bmatrix}$$

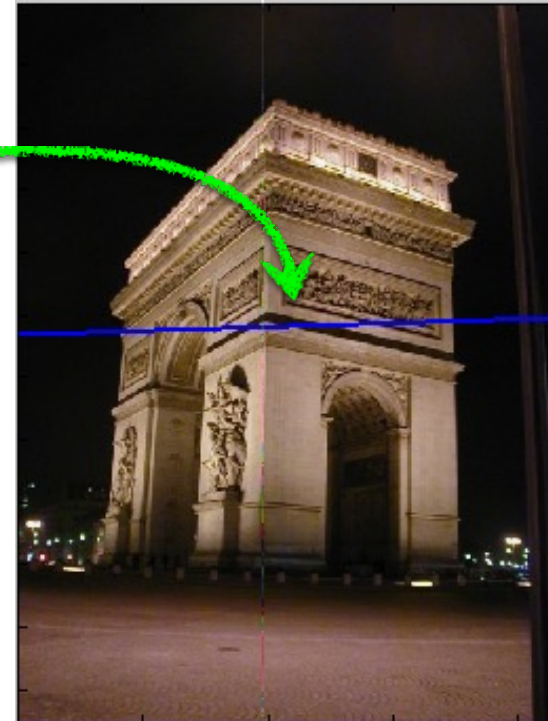
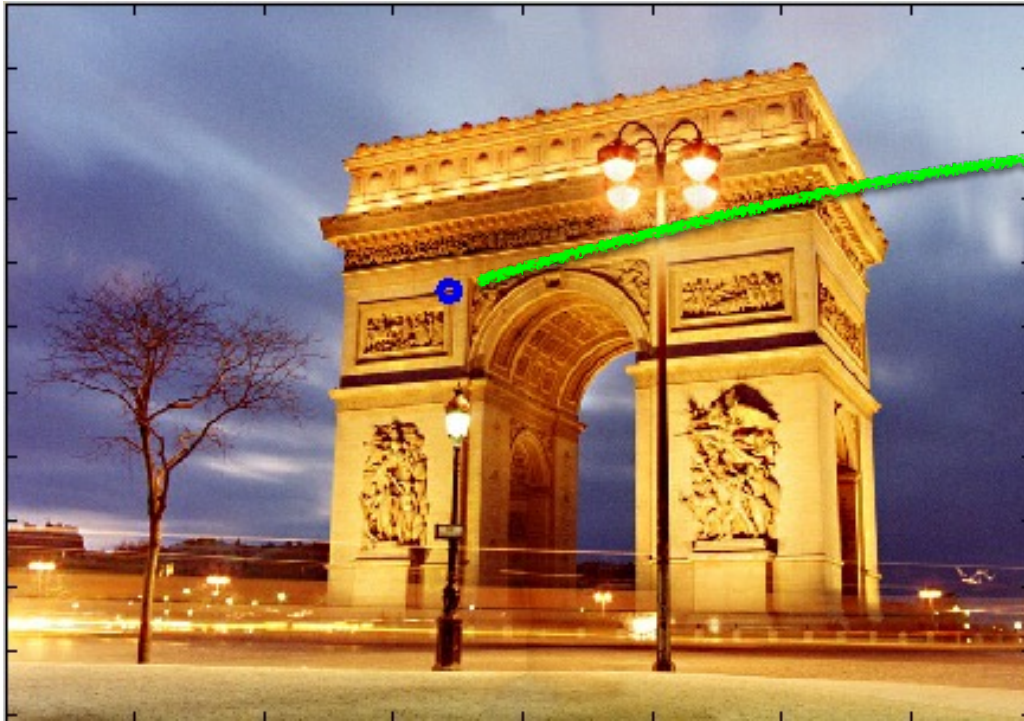

# Where is the epipole?



*How would you compute it?*



$$\mathbf{F}e = \mathbf{0}$$

The epipole is in the right null space of  $\mathbf{F}$

*How would you solve for the epipole?*



$$\mathbf{F}e = \mathbf{0}$$

The epipole is in the right null space of  $\mathbf{F}$

*How would you solve for the epipole?*

**SVD!**

SVDs are pretty  
useful, huh?