

Wrap-up



Class evaluation*s* – please take them!

- CMU's Faculty Course Evaluations (FCE): <https://cmu.smartevals.com/>
- 16-385 end-of-semester survey (see Piazza for link)
- Please take both, super helpful for developing future offerings of the class.
- Thanks in advance!

Course overview

1. Image processing. ← Lectures 1 – 6
See also 18-793: Image and Video Processing
2. Geometry-based vision. ← Lectures 7 – 12
See also 16-822: Geometry-based Methods in Vision
3. Semantic vision. ← Lectures 13 – 17
See also 16-824: Vision Learning and Recognition
See also 10-703: Deep Reinforcement Learning
4. Dealing with motion. ← Lectures 18 – 20
See also 16-831: Statistical Techniques in Robotics
See also 16-833: Robot Localization and Mapping
5. Physics-based vision. ← Lectures 21 – 25
See also 16-823: Physics-based Methods in Vision
See also 15-462: Computer Graphics
See also 15-463: Computational Photography

Image processing



Image filtering

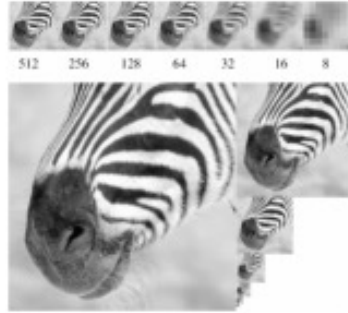

image pyramids



Fourier filtering

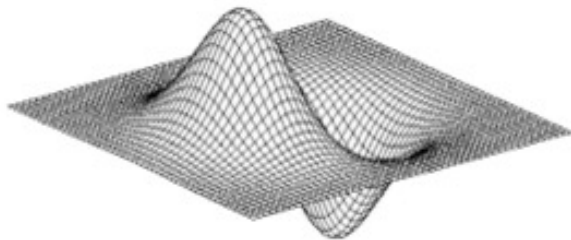
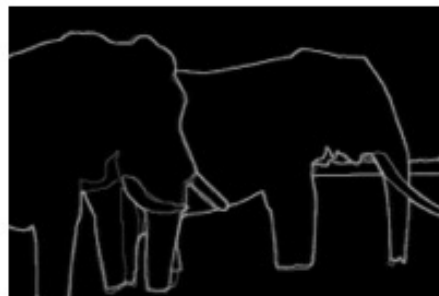
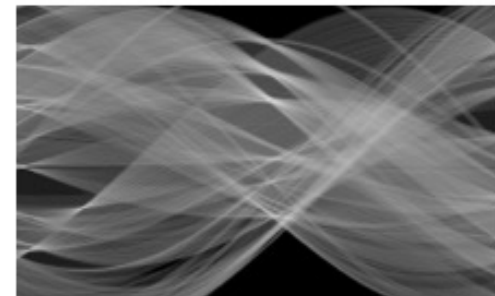

Image gradients



Boundaries



Hough Transform

Image features



Corner detection Multi-scale detection



Haar-like

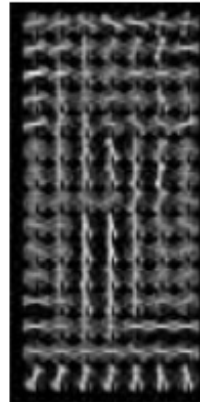

HOG

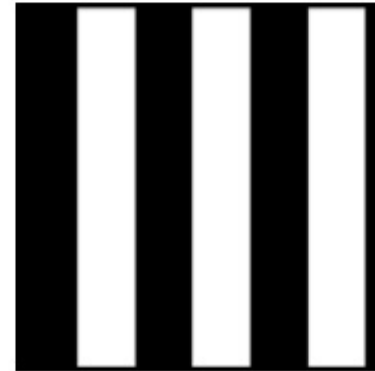

SURF

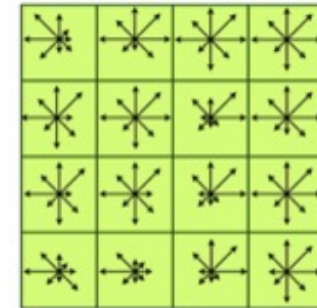

SIFT

2D alignment

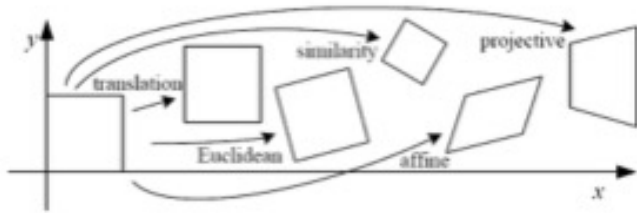

Figure 1: Basic set of 2D planar transformations

2D Transforms



DLT



RANSAC

H
Homography

Camera and multi-view geometry

$$x = PX$$

camera matrix

P

pose estimation

X

triangulation

F

fundamental matrix

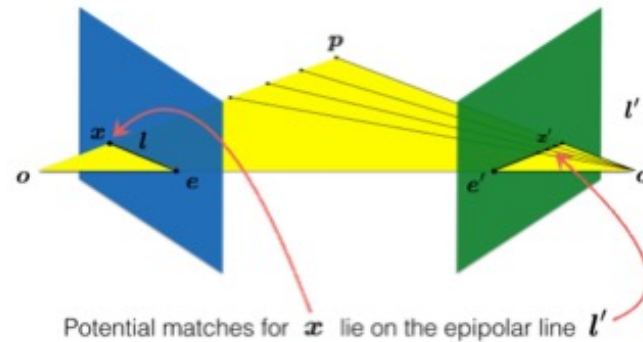

epipolar geometry



Reconstruction

Stereo



Stereo Rectification

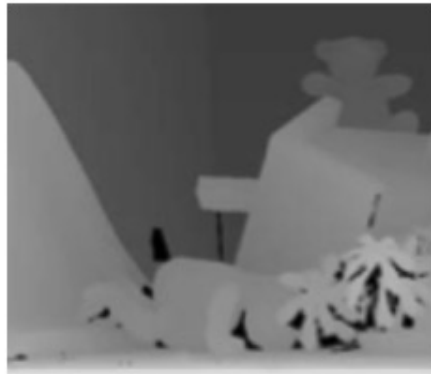

Block matching



Energy minimization

Object recognition



Bag-of-words

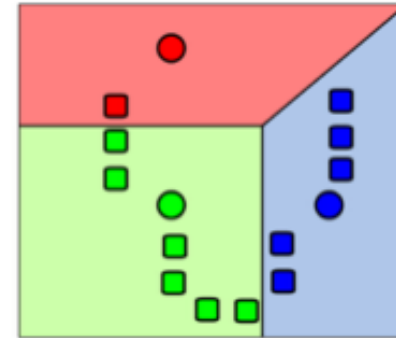

K-means

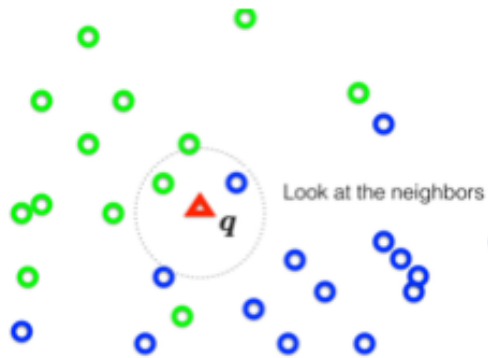

Nearest Neighbor

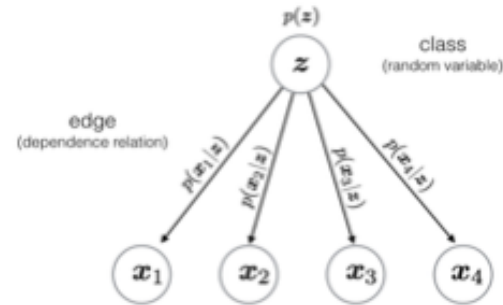

Naive Bayes

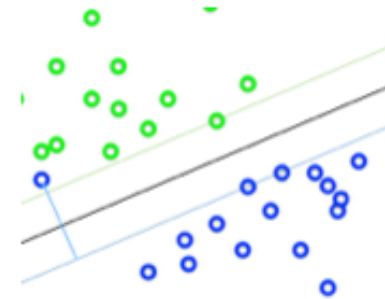

SVM

Neural networks

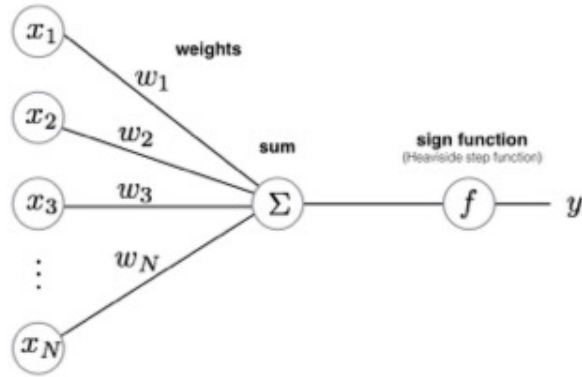

Perceptron

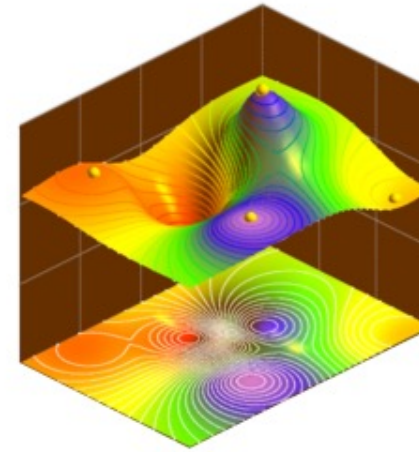

Gradient Decent

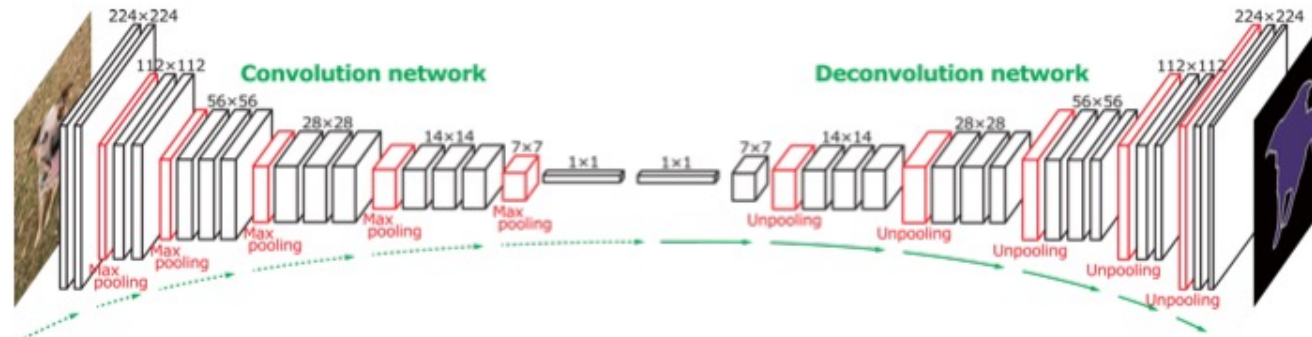

Convolutional Neural Networks

Optical flow and alignment

$$\begin{bmatrix} I_x(\mathbf{p}_1) & I_y(\mathbf{p}_1) \\ I_x(\mathbf{p}_2) & I_y(\mathbf{p}_2) \\ \vdots & \vdots \\ I_x(\mathbf{p}_{25}) & I_y(\mathbf{p}_{25}) \end{bmatrix} \begin{bmatrix} u \\ v \end{bmatrix} = - \begin{bmatrix} I_t(\mathbf{p}_1) \\ I_t(\mathbf{p}_2) \\ \vdots \\ I_t(\mathbf{p}_{25}) \end{bmatrix}$$

Constant Flow

$$\min_{\mathbf{u}, \mathbf{v}} \sum_{ij} \left\{ E_d(i, j) + \lambda E_s(i, j) \right\}$$

Horn-Schunck



Lucas-Kanade
(Forward additive)

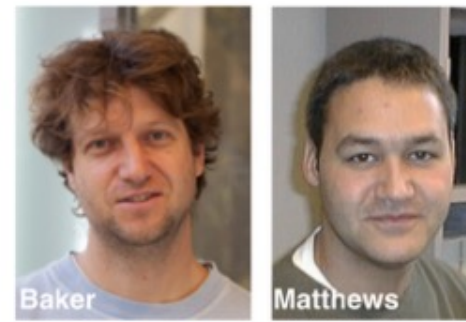

Baker-Matthews
(Inverse Compositional)

Tracking in videos



KLT

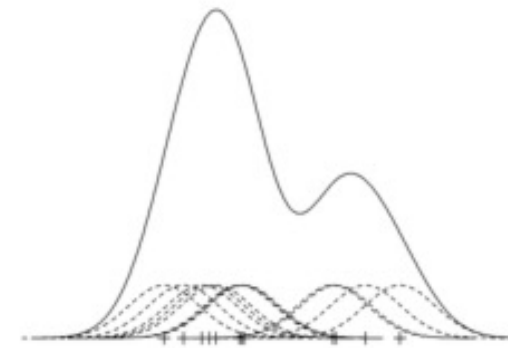

Mean shift

Image formation and physics

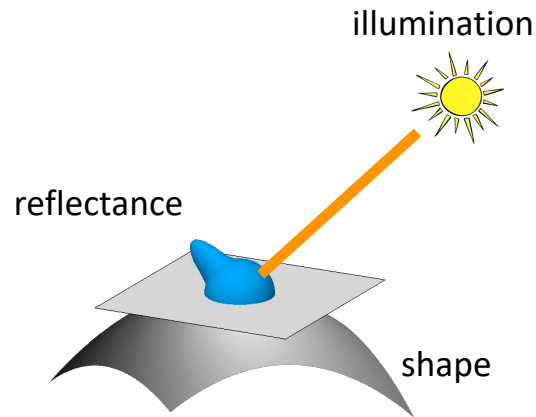

Radiometry and image formation

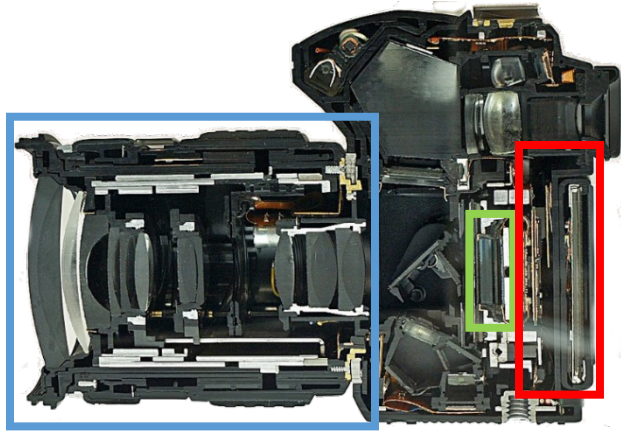
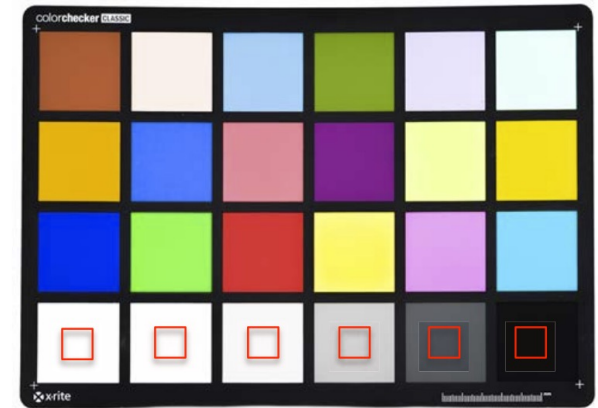

Image processing pipeline

Photometric stereo



Radiometric and color calibration

Things you should know how to do

1. Detect lines (circles, shapes) in an image.
2. Perform automatic image warping and basic AR.
3. Reconstruct 3D scene structure from two images.
4. Do photometric stereo and render simple images.
5. Recognize objects using a bag-of-words model.
6. Recognize objects using deep CNNs.
7. Track objects in video.

Questions?

Do you plan on taking any other vision courses?

Which part of the class did you like the most?

Which part of the class did you like the least?

Any topics you wanted to learn more about?

Any topics you wanted to learn less about?

Which was your favorite programming assignment?

Which was your least favorite programming assignment?

Did you find the take-home quizzes useful?

How does course workload compare to other classes?

What was your experience with office hours?