

Radiometry and reflectance

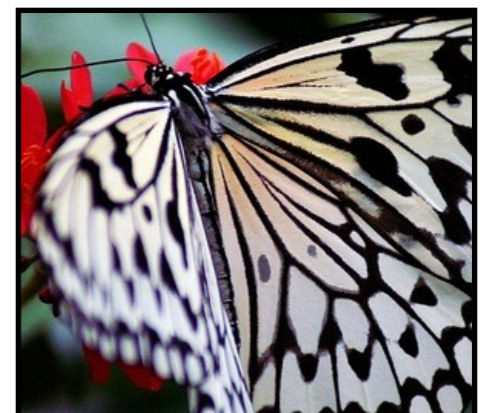

Overview of today's lecture

- Appearance phenomena.
- Measuring light and radiometry.
- Reflectance and BRDF.

Slide credits

Most of these slides were adapted from:

- Srinivasa Narasimhan (16-385, Spring 2014).
- Todd Zickler (Harvard University).
- Steven Gortler (Harvard University).

Appearance

Appearance

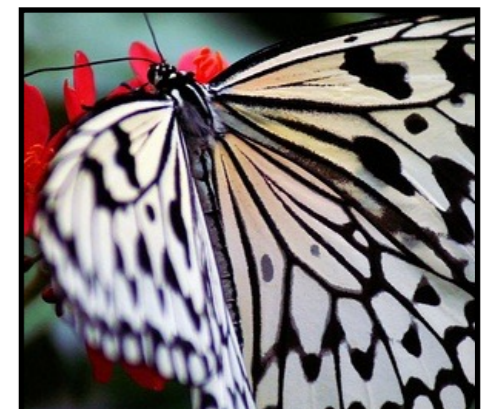

“Physics-based” computer vision (a.k.a “inverse optics”)

Our challenge: Invent computational representations of shape, lighting, and reflectance that are *efficient*: simple enough to make inference tractable, yet general enough to capture the world’s most important phenomena

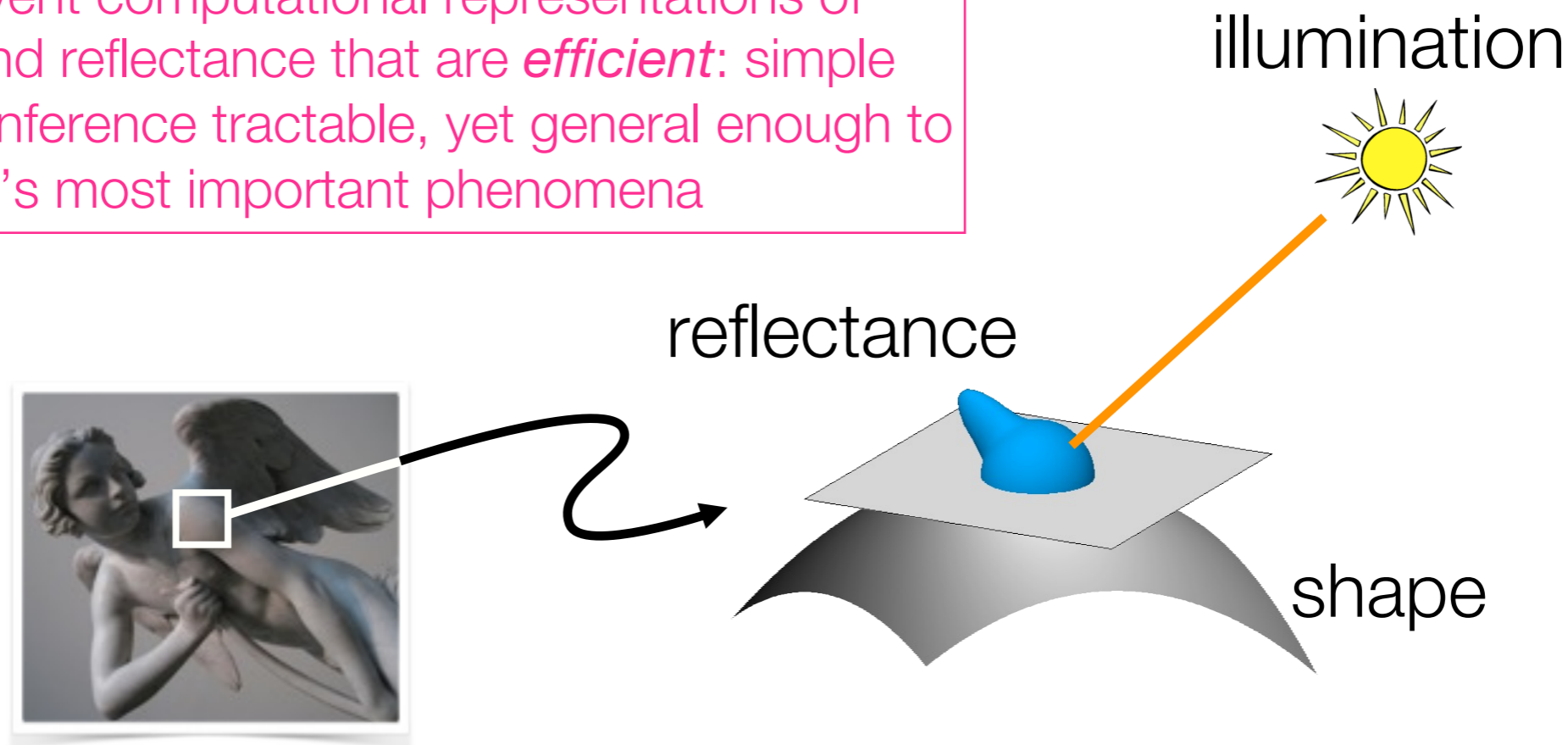

I \longrightarrow shape, illumination, reflectance

Example application: Photometric Stereo

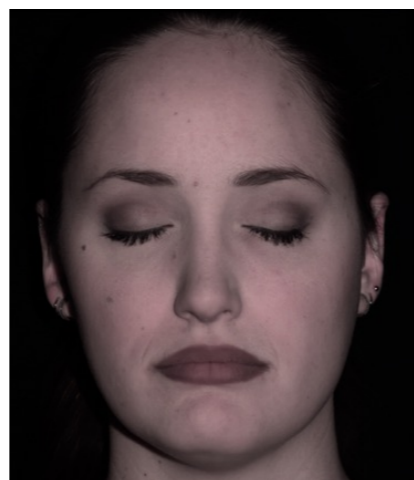
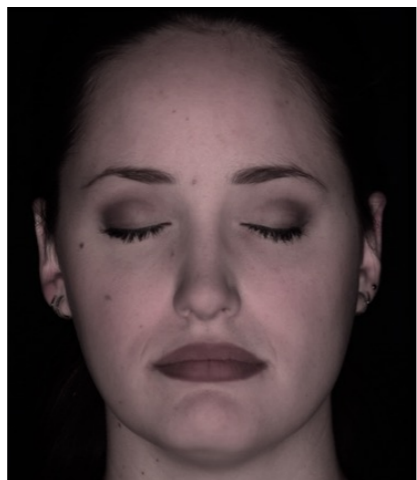
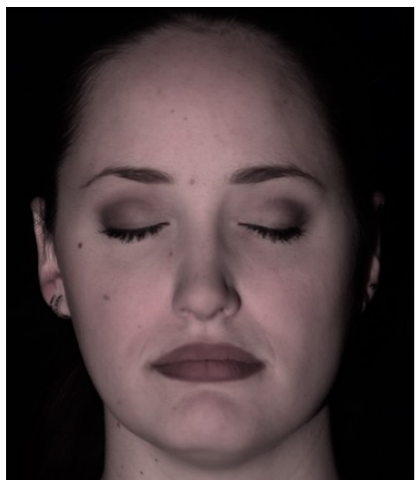
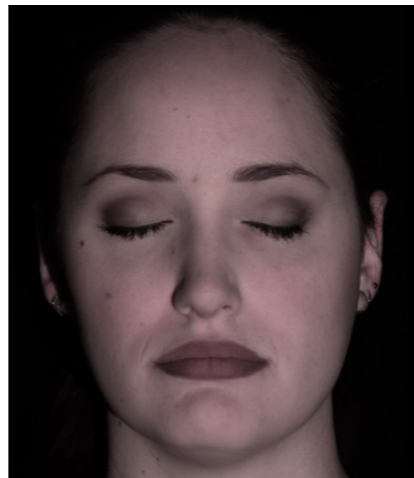
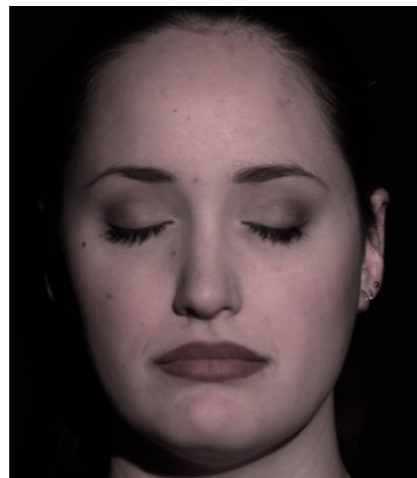
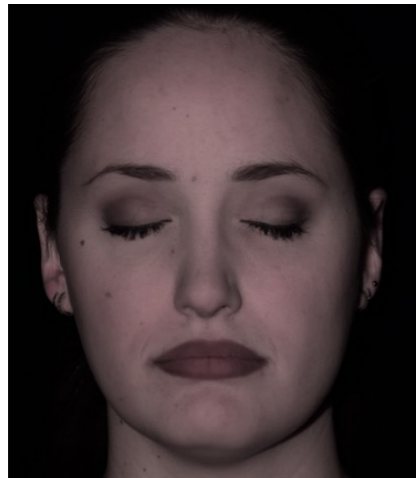
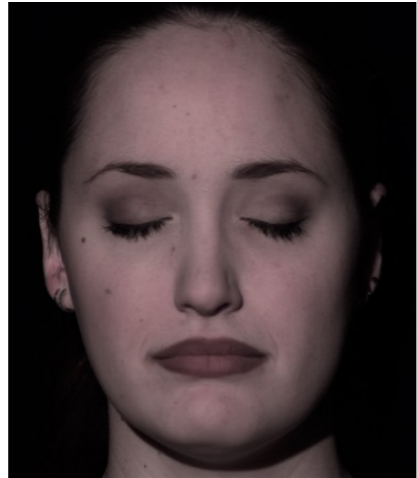

Why study the physics (optics) of the
world?

Lets see some pictures!

Light and Shadows





Reflections







Refractions

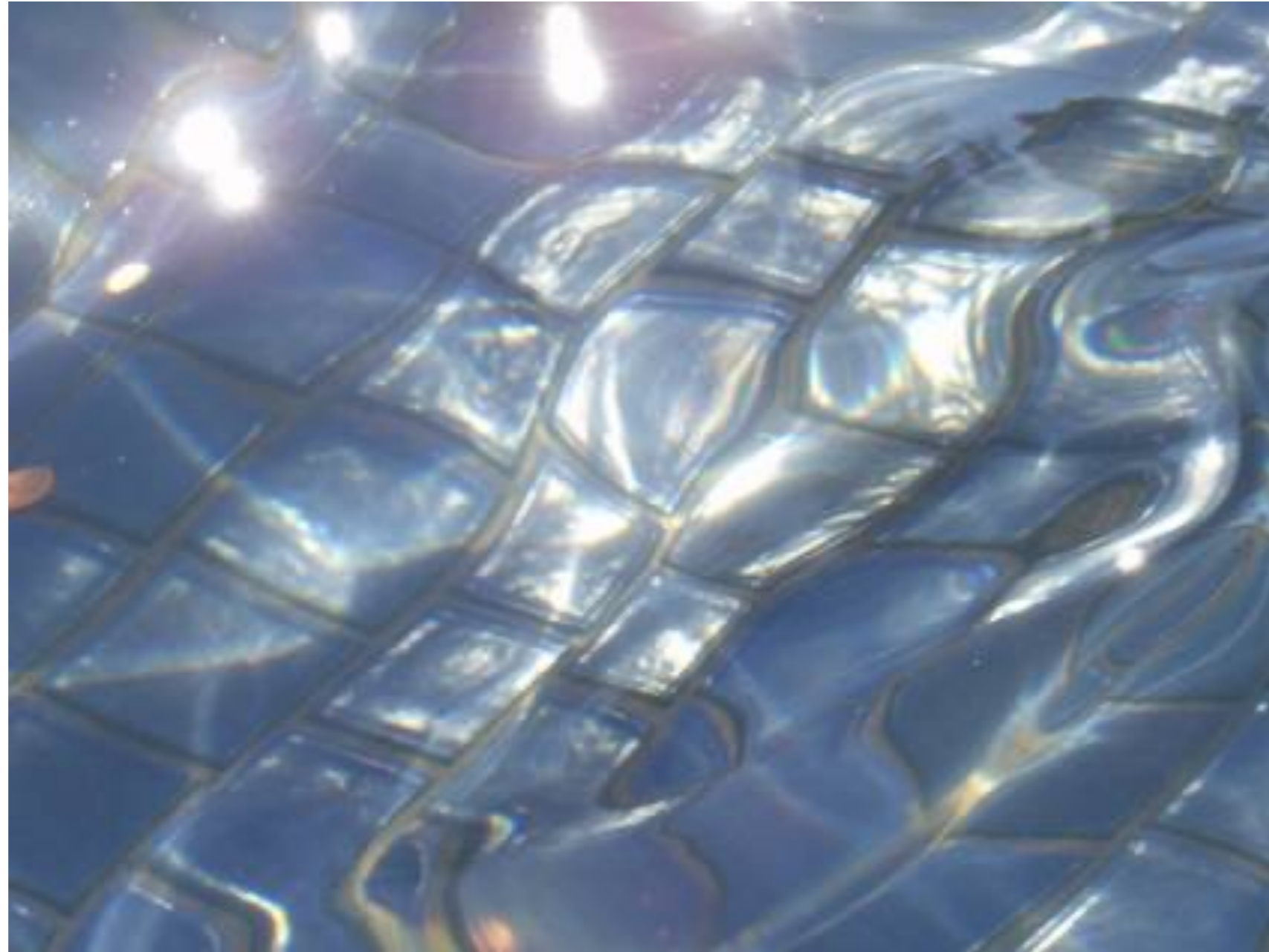



HENRIK WANN JENSEN 1995

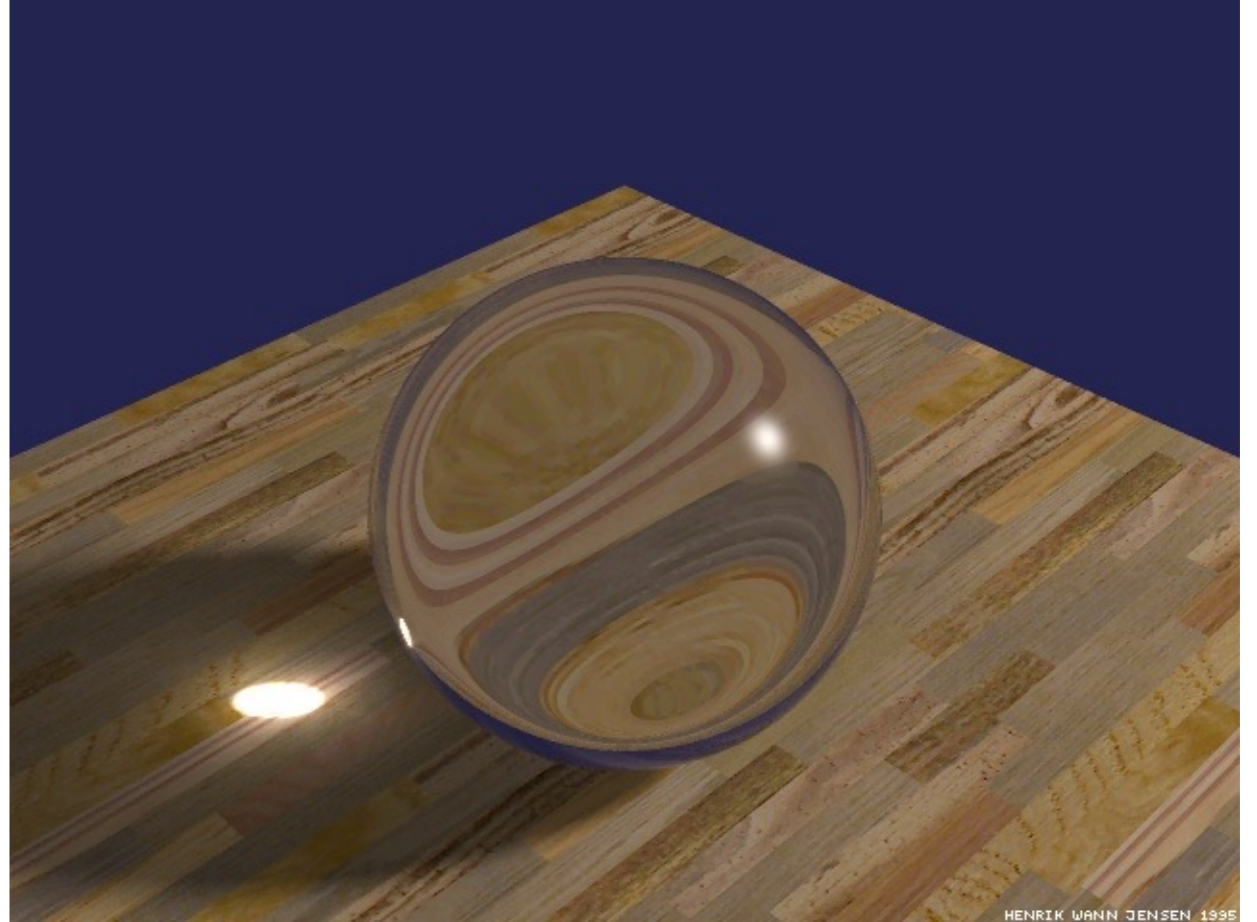

HENRIK WANN JENSEN 1995



Interreflections



Scattering

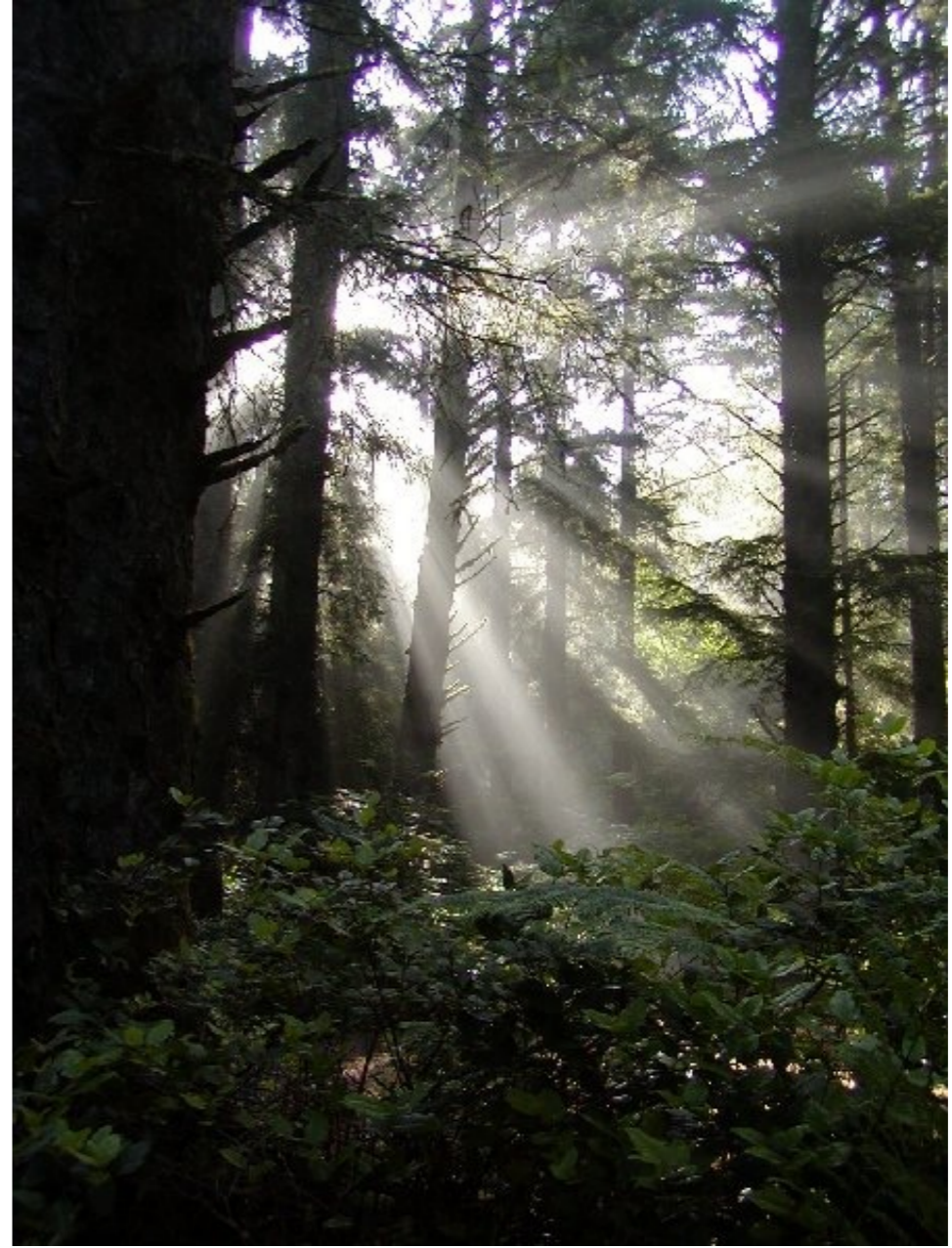





More Complex Appearances



opaque



translucent









Measuring light and radiometry

Solid angle

- The *solid angle* subtended by a small surface patch with respect to point O is the area of its central projection onto the unit sphere about O

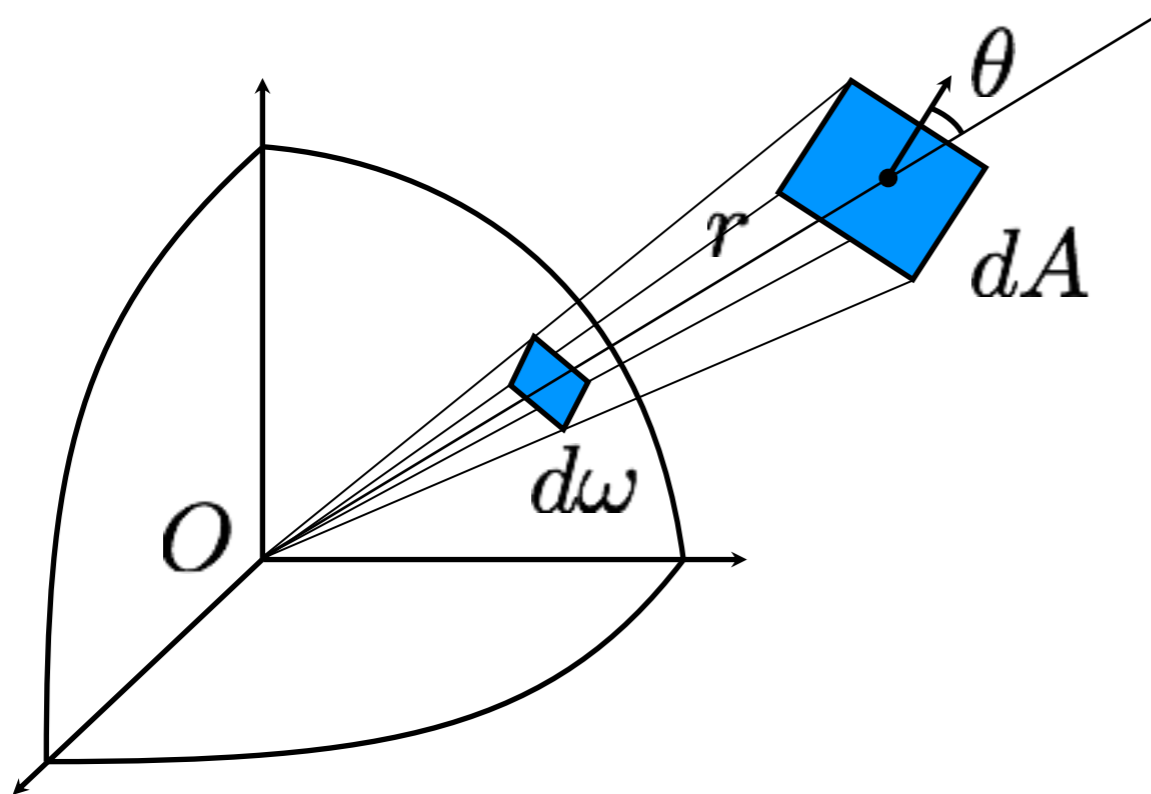

Depends on:

- orientation of patch
- distance of patch

Solid angle

- The *solid angle* subtended by a small surface patch with respect to point O is the area of its central projection onto the unit sphere about O

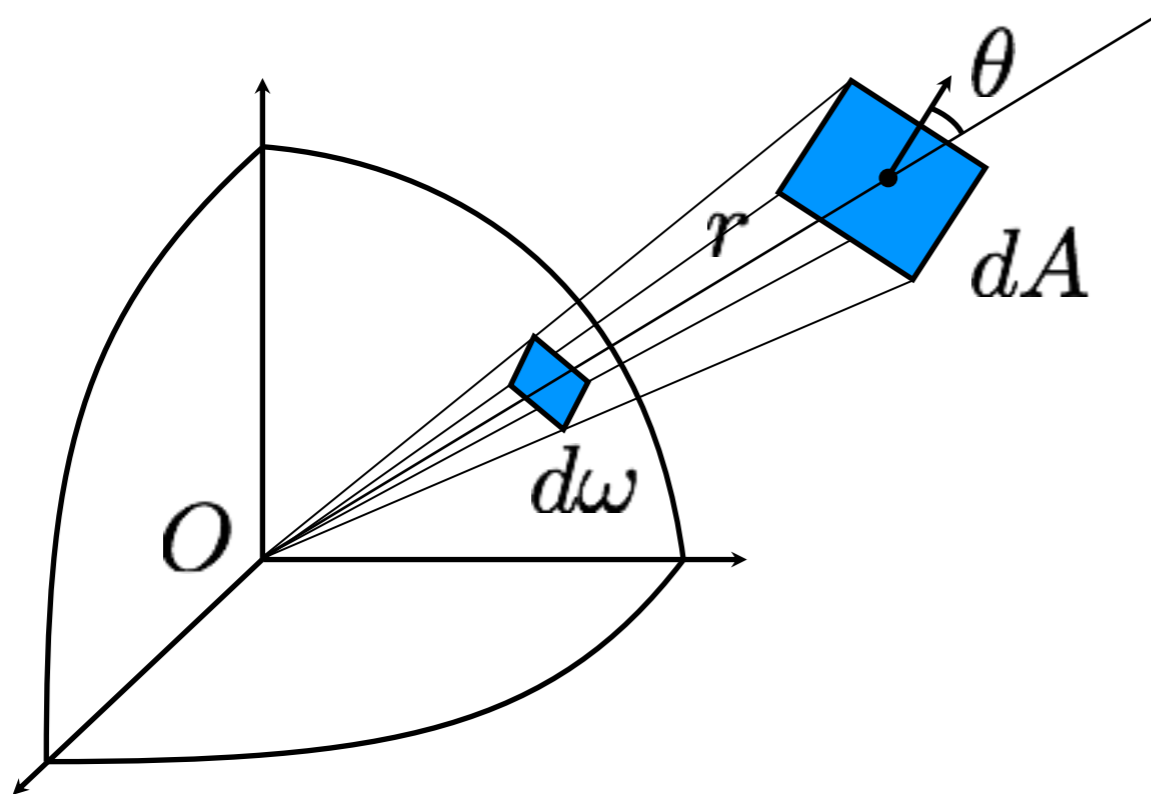

Depends on:

- orientation of patch
- distance of patch

One can show:

$$d\omega = \frac{dA \cos \theta}{r^2}$$

Units: steradians [sr]

Solid angle

- The *solid angle* subtended by a small surface patch with respect to point O is the area of its central projection onto the unit sphere about O

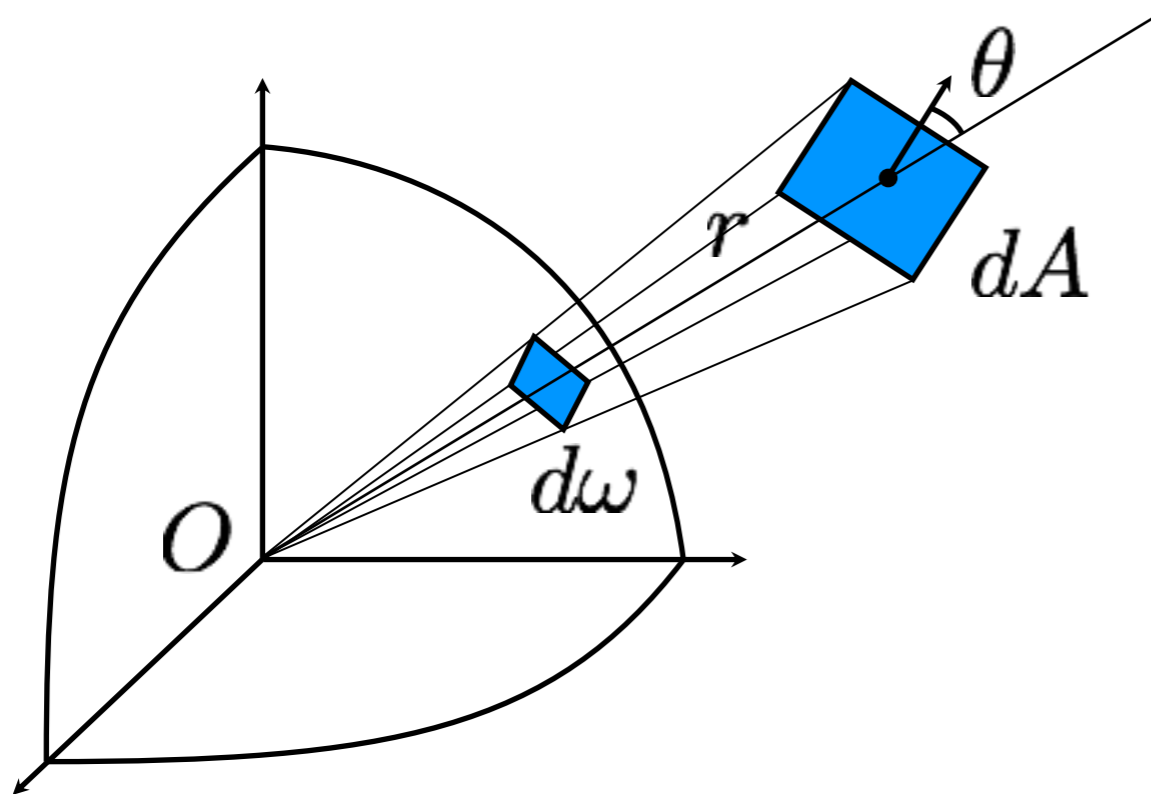

Depends on:

- orientation of patch
- distance of patch

One can show:

“surface foreshortening”

$$d\omega = \frac{dA \cos \theta}{r^2}$$

Units: steradians [sr]

Solid angle

- To calculate solid angle subtended by a surface S relative to O you must add up (integrate) contributions from all tiny patches (nasty integral)

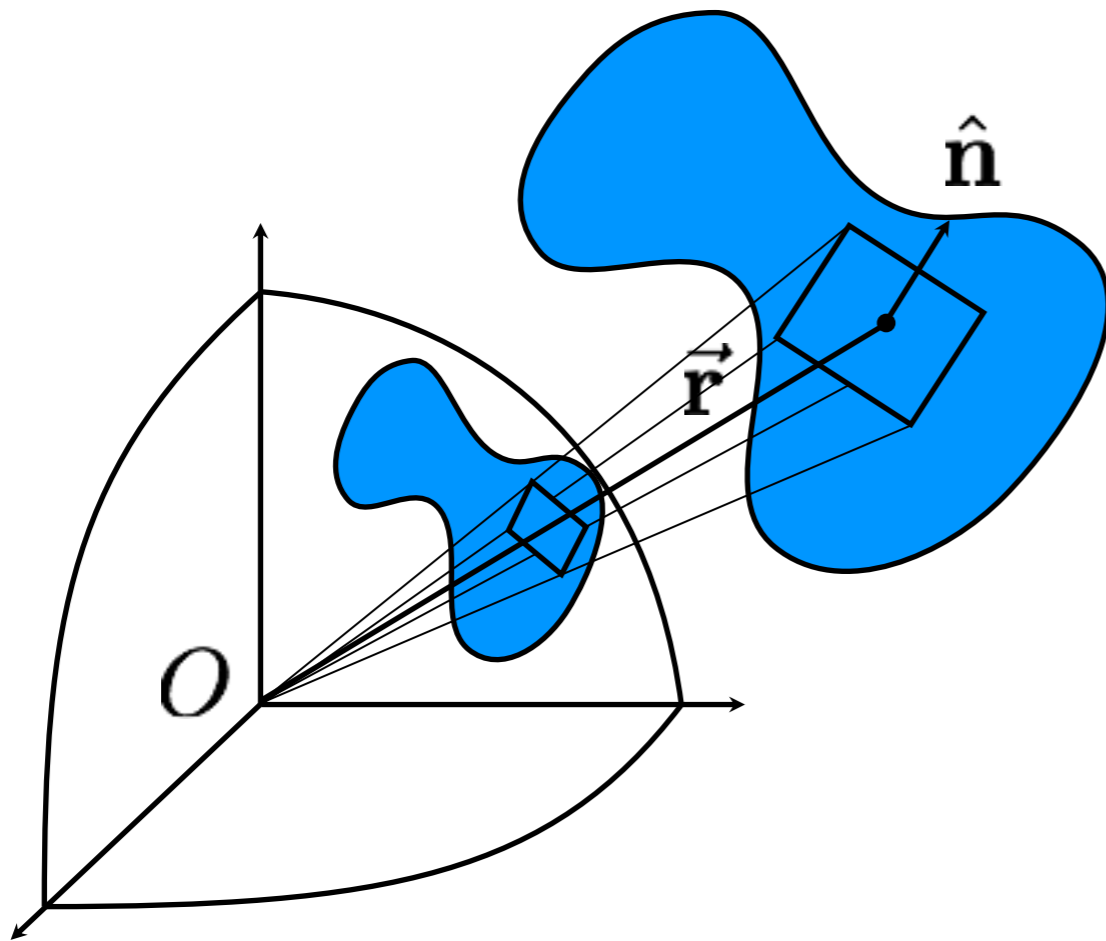

$$\Omega = \iint_S \frac{\vec{r} \cdot \hat{n} dS}{|\vec{r}|^3}$$

One can show:

“surface foreshortening”

$$d\omega = \frac{dA \cos \theta}{r^2}$$

Units: steradians [sr]

Question

- Suppose surface S is a hemisphere centered at O . What is the solid angle it subtends?

Question

- Suppose surface S is a hemisphere centered at O . What is the solid angle it subtends?
- Answer: 2π (area of sphere is $4\pi r^2$; area of unit sphere is 4π ; half of that is 2π)

Quantifying light: flux, irradiance, and radiance

- Imagine a sensor that counts photons passing through planar patch X in directions within angular wedge W
- It measures *radiant flux* [watts = joules/sec]: rate of photons hitting sensor area
- Measurement depends on sensor area $|X|$

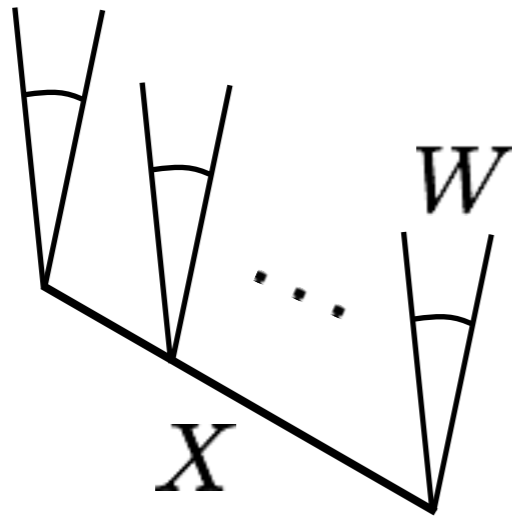

* shown in 2D for clarity; imagine three dimensions

radiant flux $\Phi(W, X)$

Quantifying light: flux, irradiance, and radiance

- *Irradiance*:
A measure of incoming light that is independent of sensor area $|X|$
- Units: watts per square meter $[\text{W}/\text{m}^2]$

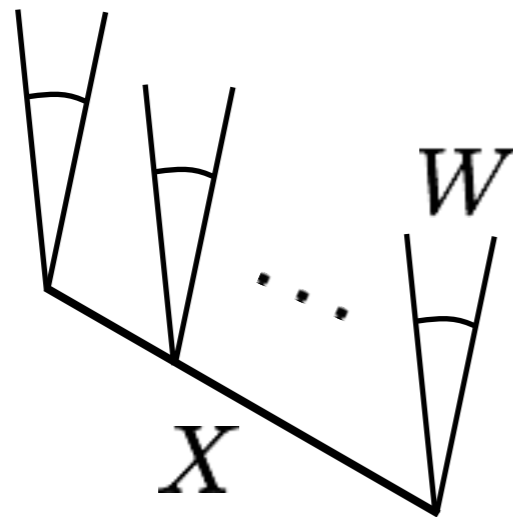

$$\frac{\Phi(W, X)}{|X|}$$

Quantifying light: flux, irradiance, and radiance

- *Irradiance*:
A measure of incoming light that is independent of sensor area $|X|$
- Units: watts per square meter $[\text{W}/\text{m}^2]$

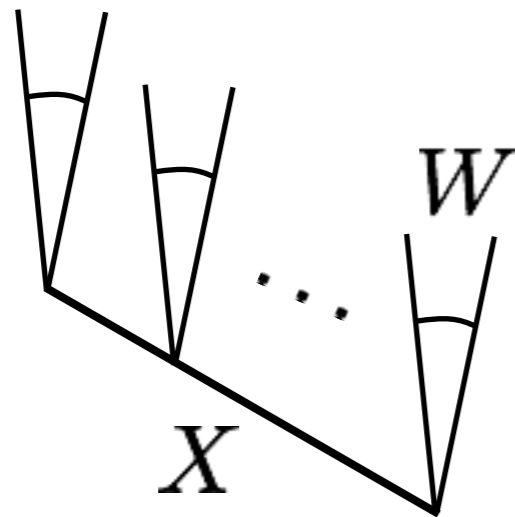

$$\lim_{X \rightarrow x}$$

$$\frac{\Phi(W, X)}{|X|}$$

Quantifying light: flux, irradiance, and radiance

- *Irradiance*:
A measure of incoming light that is independent of sensor area $|X|$
- Units: watts per square meter $[\text{W}/\text{m}^2]$
- Depends on sensor direction normal.

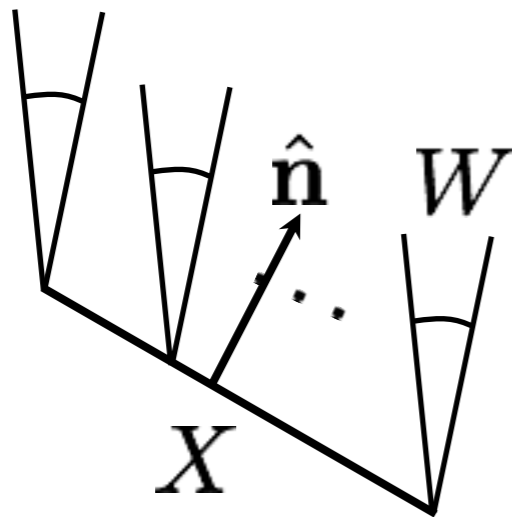

$$\frac{\Phi(W, X)}{|X|}$$

$$\lim_{X \rightarrow x}$$

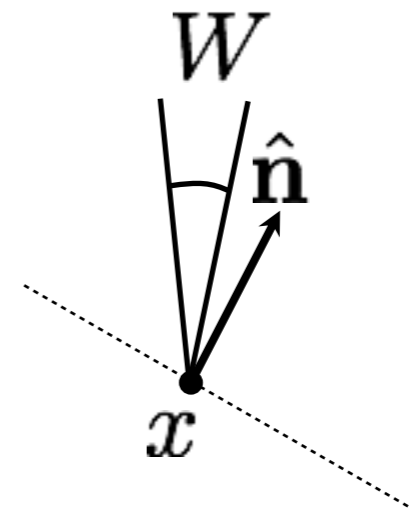

$$E_{\hat{n}}(W, x)$$

- We keep track of the normal because a planar sensor with distinct orientation would converge to a different limit
- In the literature, notations n and W are often omitted, and values are implied by context

Quantifying light: flux, irradiance, and radiance

- *Radiance*:

A measure of incoming light that is independent of sensor area $|X|$, orientation \hat{n} , and wedge size (solid angle) $|W|$

- Units: watts per steradian per square meter $[W/(m^2 \cdot sr)]$

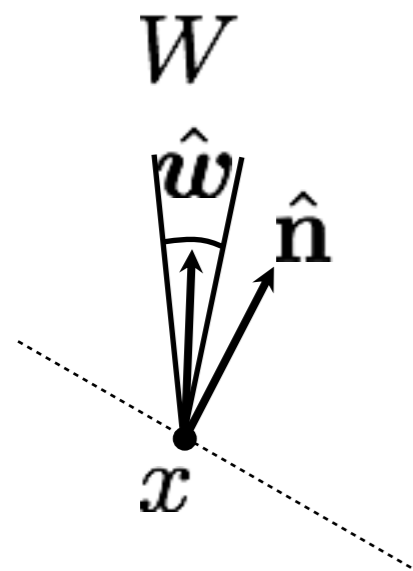

$$\frac{E_{\hat{n}}(W, x)}{|W|}$$

$\lim_{W \rightarrow \hat{\omega}}$

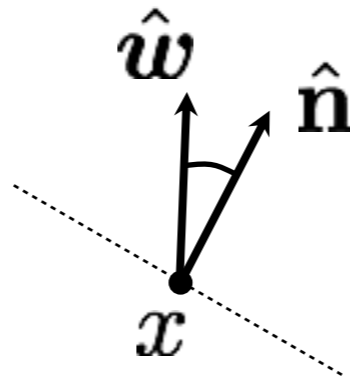

$$L_{\hat{n}}(\hat{\omega}, x)$$

- Has correct units, but still depends on sensor orientation
- To correct this, convert to measurement that would have been made if sensor was perpendicular to direction ω

Quantifying light: flux, irradiance, and radiance

- *Radiance*:
A measure of incoming light that is independent of sensor area $|X|$, orientation \hat{n} , and wedge size (solid angle) $|W|$
- Units: watts per steradian per square meter $[W/(m^2 \cdot sr)]$

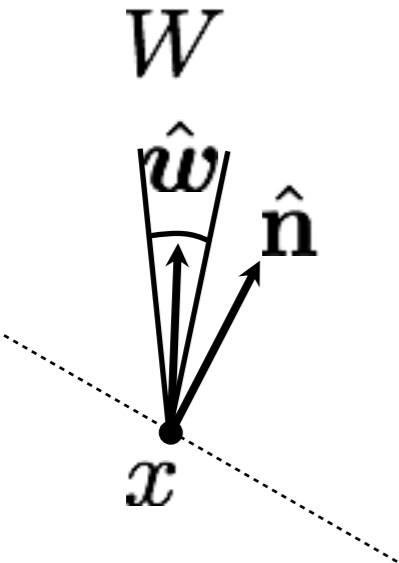

$$\lim_{W \rightarrow \hat{w}}$$

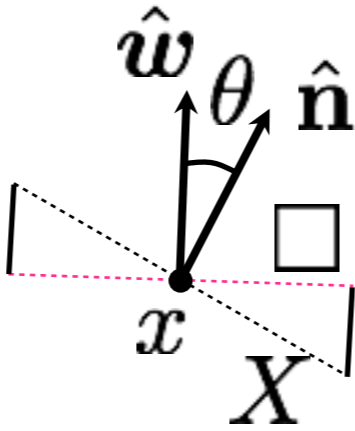

$$\cos \theta = \frac{\square/2}{|X|/2}$$

$$\rightarrow \square = |X| \cos \theta$$

“foreshortened area”

$$\frac{E_{\hat{n}}(W, x)}{|W|}$$

$$L_{\hat{n}}(\hat{w}, x)$$

- Has correct units, but still depends on sensor orientation
- To correct this, convert to measurement that would have been made if sensor was perpendicular to direction w

Quantifying light: flux, irradiance, and radiance

- *Radiance:*

A measure of incoming light that is independent of sensor area $|X|$, orientation \hat{n} , and wedge size (solid angle) $|W|$

- Units: watts per steradian per square meter $[W/(m^2 \cdot sr)]$

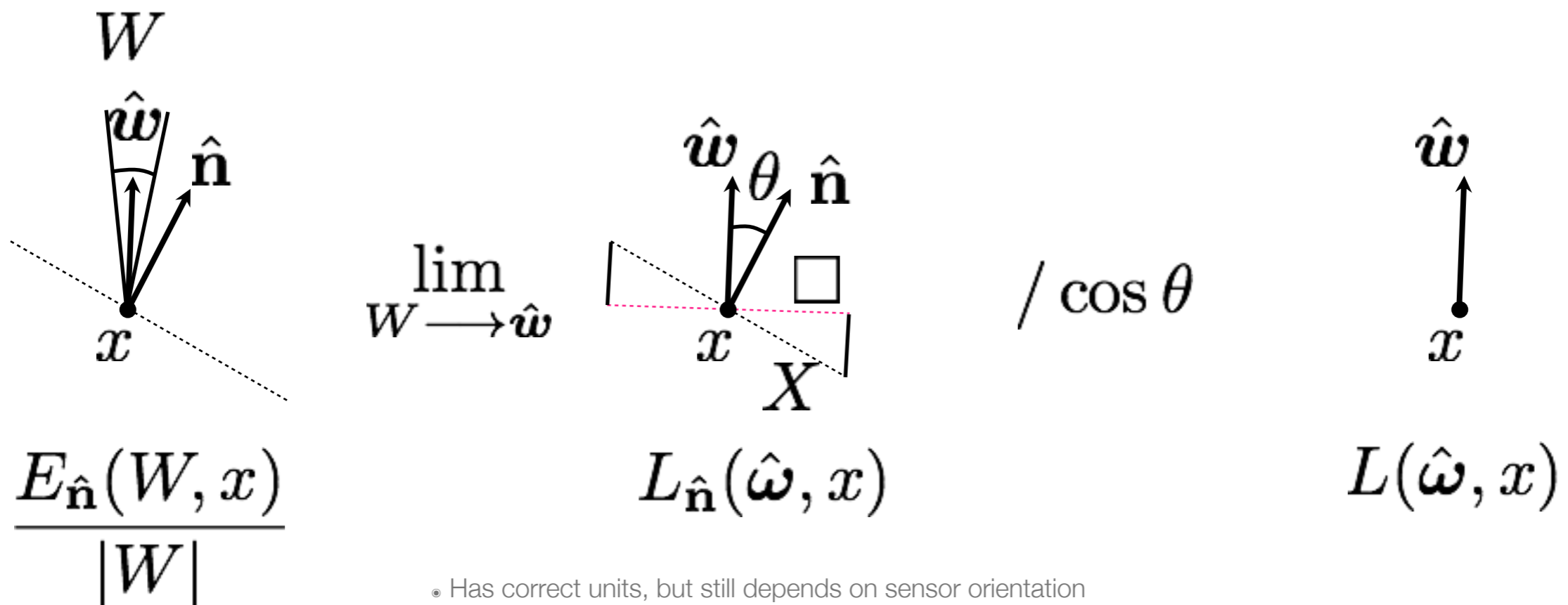

- Has correct units, but still depends on sensor orientation
- To correct this, convert to measurement that would have been made if sensor was perpendicular to direction ω

Quantifying light: flux, irradiance, and radiance

- *Radiance*:

A measure of incoming light that is independent of sensor area $|X|$, orientation \hat{n} , and wedge size (solid angle) $|W|$

- Units: watts per steradian per square meter $[W/(m^2 \cdot sr)]$

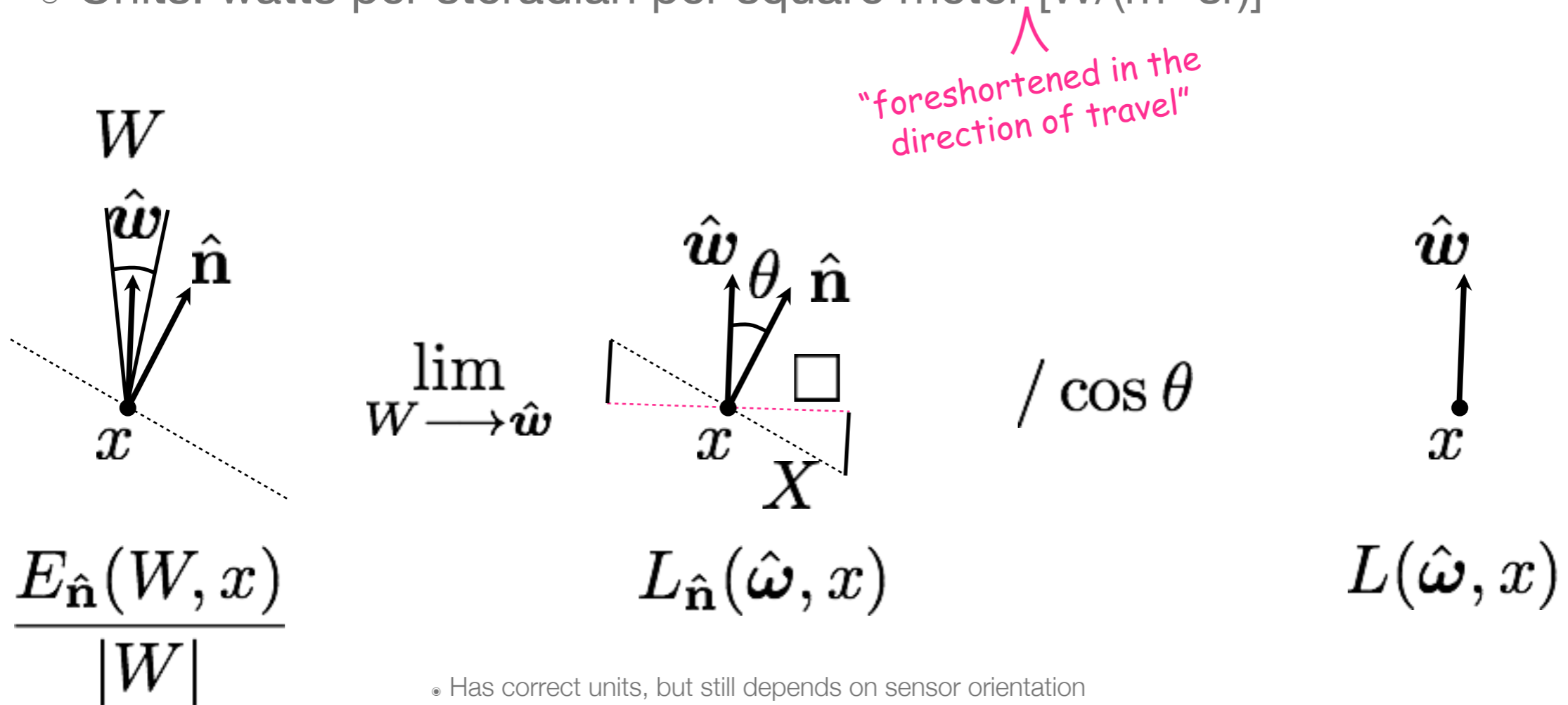

- Has correct units, but still depends on sensor orientation
- To correct this, convert to measurement that would have been made if sensor was perpendicular to direction w

Quantifying light: flux, irradiance, and radiance

- ◉ Attractive properties of radiance:
 - Allows computing the radiant flux measured by *any* finite sensor

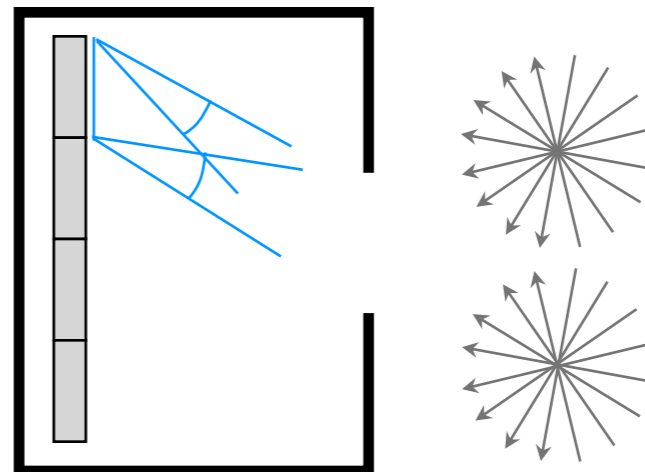

Quantifying light: flux, irradiance, and radiance

- Attractive properties of radiance:
 - Allows computing the radiant flux measured by *any* finite sensor

$$\Phi(W, X) = \int_X \int_W L(\hat{\omega}, x) \cos \theta d\omega dA$$

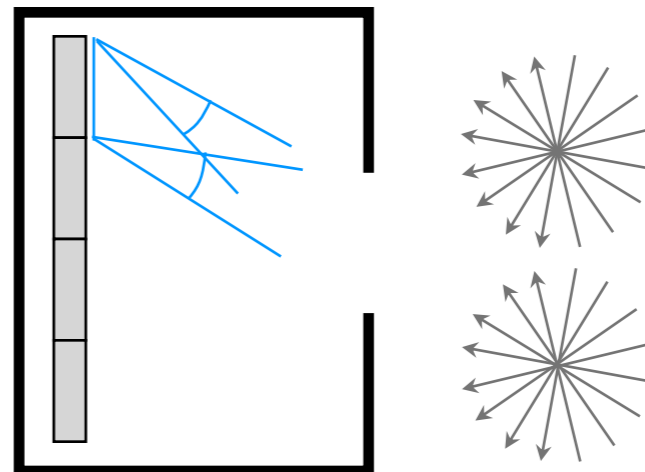

Quantifying light: flux, irradiance, and radiance

- Attractive properties of radiance:

- Allows computing the radiant flux measured by *any* finite sensor

$$\Phi(W, X) = \int_X \int_W L(\hat{\omega}, x) \cos \theta d\omega dA$$

- Constant along a ray in free space

$$L(\hat{\omega}, x) = L(\hat{\omega}, x + \hat{\omega})$$

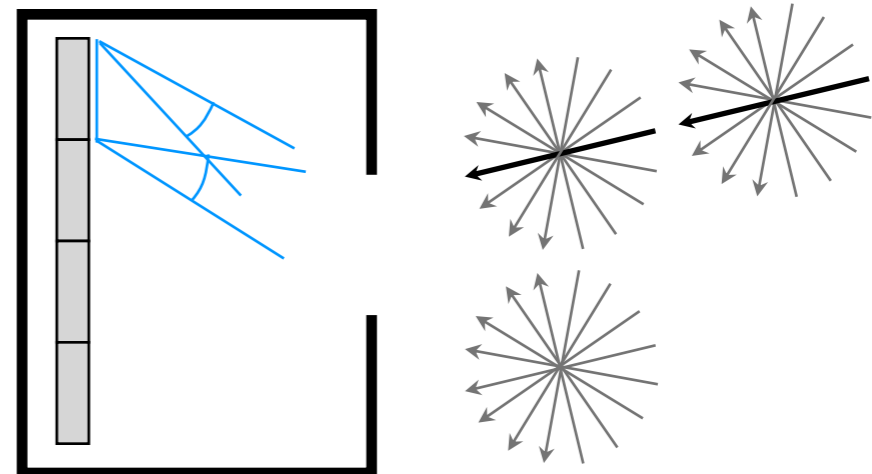

Quantifying light: flux, irradiance, and radiance

- Attractive properties of radiance:

- Allows computing the radiant flux measured by *any* finite sensor

$$\Phi(W, X) = \int_X \int_W L(\hat{\omega}, x) \cos \theta d\omega dA$$

- Constant along a ray in free space

$$L(\hat{\omega}, x) = L(\hat{\omega}, x + \hat{\omega})$$

- A camera measures radiance (after a one-time radiometric calibration). So RAW pixel values are proportional to radiance.
 - “Processed” images (like PNG and JPEG) are not linear radiance measurements!!

Question

- Most light sources, like a heated metal sheet, follow Lambert's Law

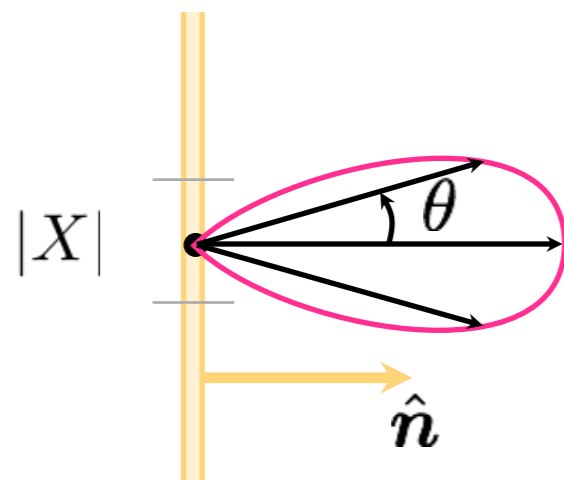

$$J(\hat{\omega}) = J_o \langle \hat{\omega}, \hat{n} \rangle = J_o \cos \theta$$

↑
radiant intensity [W/sr]

“Lambertian
area source”

- What is the radiance $L(\hat{\omega}, \mathbf{x})$ of an infinitesimal patch [W/sr·m²]?

Question

- Most light sources, like a heated metal sheet, follow Lambert's Law

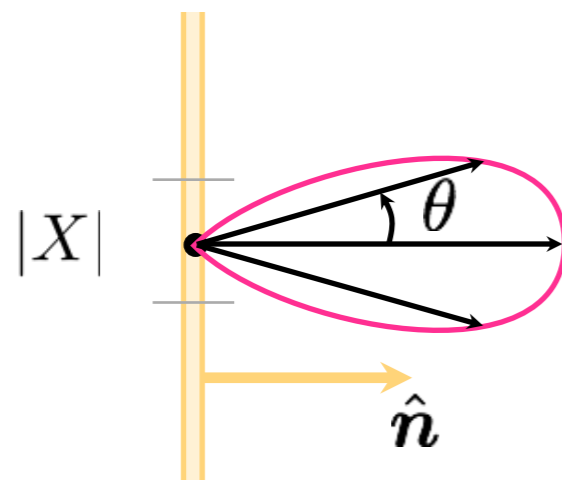

$$J(\hat{\omega}) = J_o \langle \hat{\omega}, \hat{n} \rangle = J_o \cos \theta$$

↑
radiant intensity [W/sr]

“Lambertian
area source”

- What is the radiance $L(\hat{\omega}, \mathbf{x})$ of an infinitesimal patch [W/sr·m²]?

Answer: $L(\hat{\omega}, \mathbf{x}) = J_o/|X|$ (independent of direction)

Question

- Most light sources, like a heated metal sheet, follow Lambert's Law

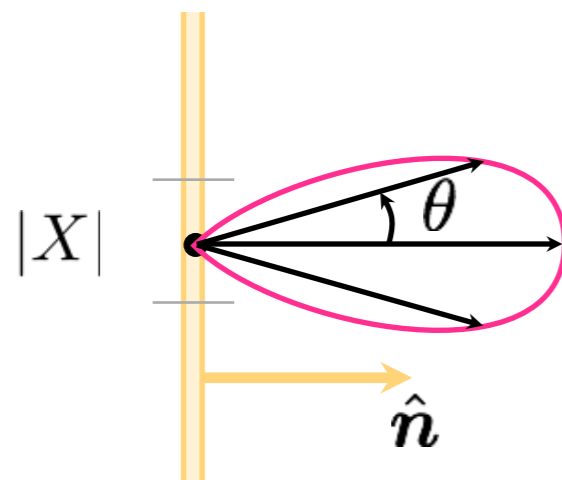

$$J(\hat{\omega}) = J_o \langle \hat{\omega}, \hat{n} \rangle = J_o \cos \theta$$

↑
radiant intensity [W/sr]

“Lambertian
area source”

- What is the radiance $L(\hat{\omega}, \mathbf{x})$ of an infinitesimal patch [W/sr·m²]?

Answer: $L(\hat{\omega}, \mathbf{x}) = J_o/|X|$ (independent of direction)

“Looks equally bright when viewed from any direction”

Radiometric concepts – boring...but, important!

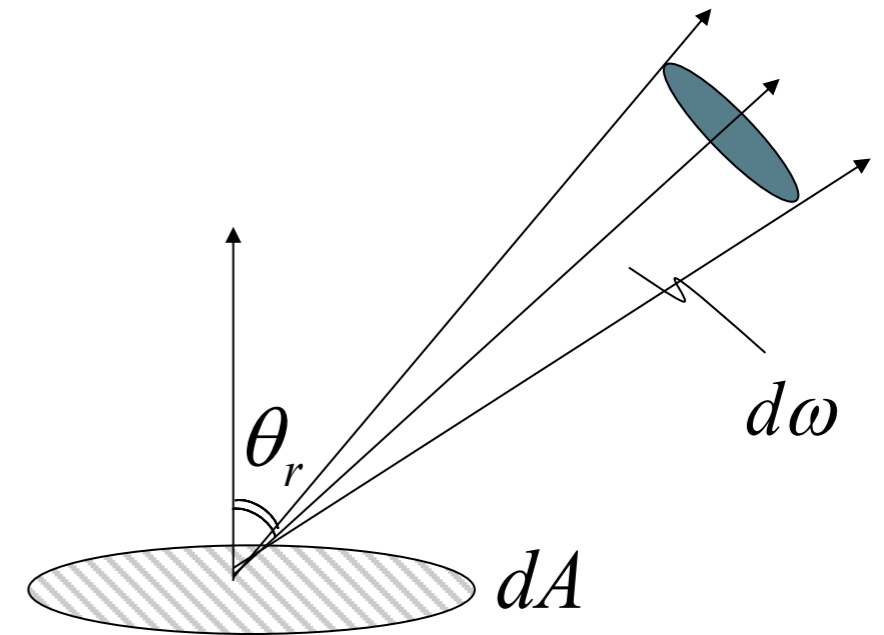
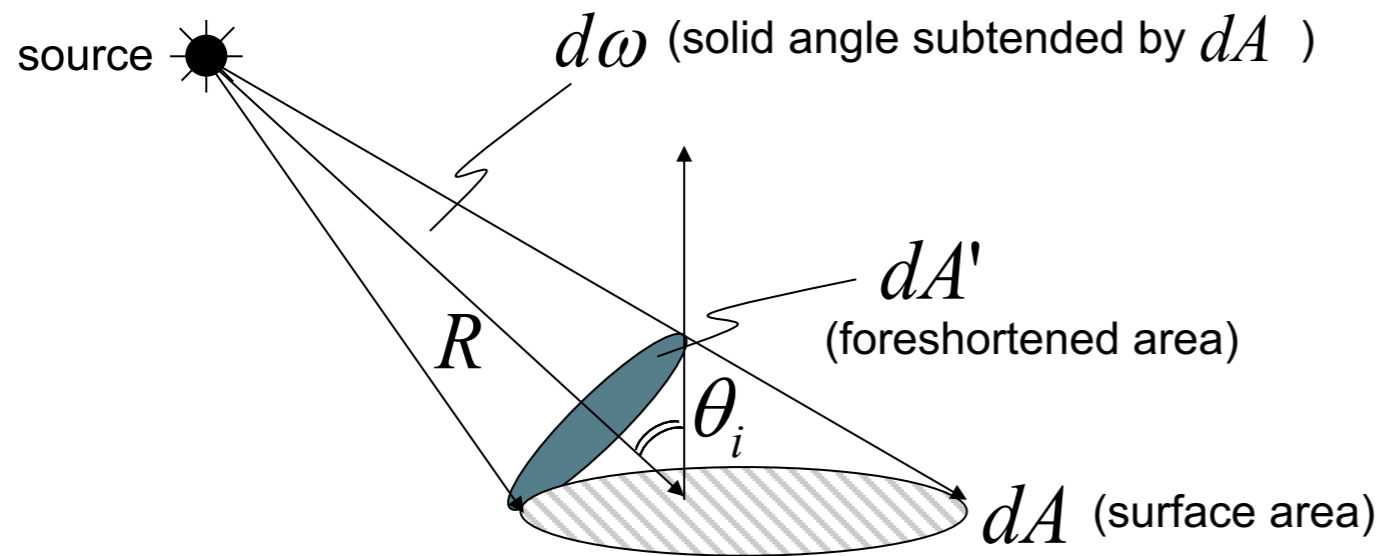

(1) Solid Angle : $d\omega = \frac{dA'}{R^2} = \frac{dA \cos \theta_i}{R^2}$ (steradian)

What is the solid angle subtended by a hemisphere?

(2) Radiant Intensity of Source : $J = \frac{d\Phi}{d\omega}$ (watts / steradian)

Light Flux (power) emitted per unit solid angle

(3) Surface Irradiance : $E = \frac{d\Phi}{dA}$ (watts / m²)

Light Flux (power) incident per unit surface area.

Does not depend on where the light is coming from!

(4) Surface Radiance (tricky) :

$$L = \frac{d^2\Phi}{(dA \cos \theta_r) d\omega} \text{ (watts / m}^2 \text{ steradian)}$$

- Flux emitted per unit foreshortened area per unit solid angle.
- L depends on direction θ_r
- Surface can radiate into whole hemisphere.
- L depends on reflectance properties of surface.

Appearance

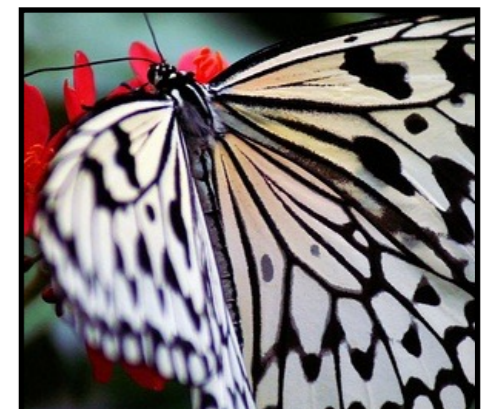

“Physics-based” computer vision (a.k.a “inverse optics”)

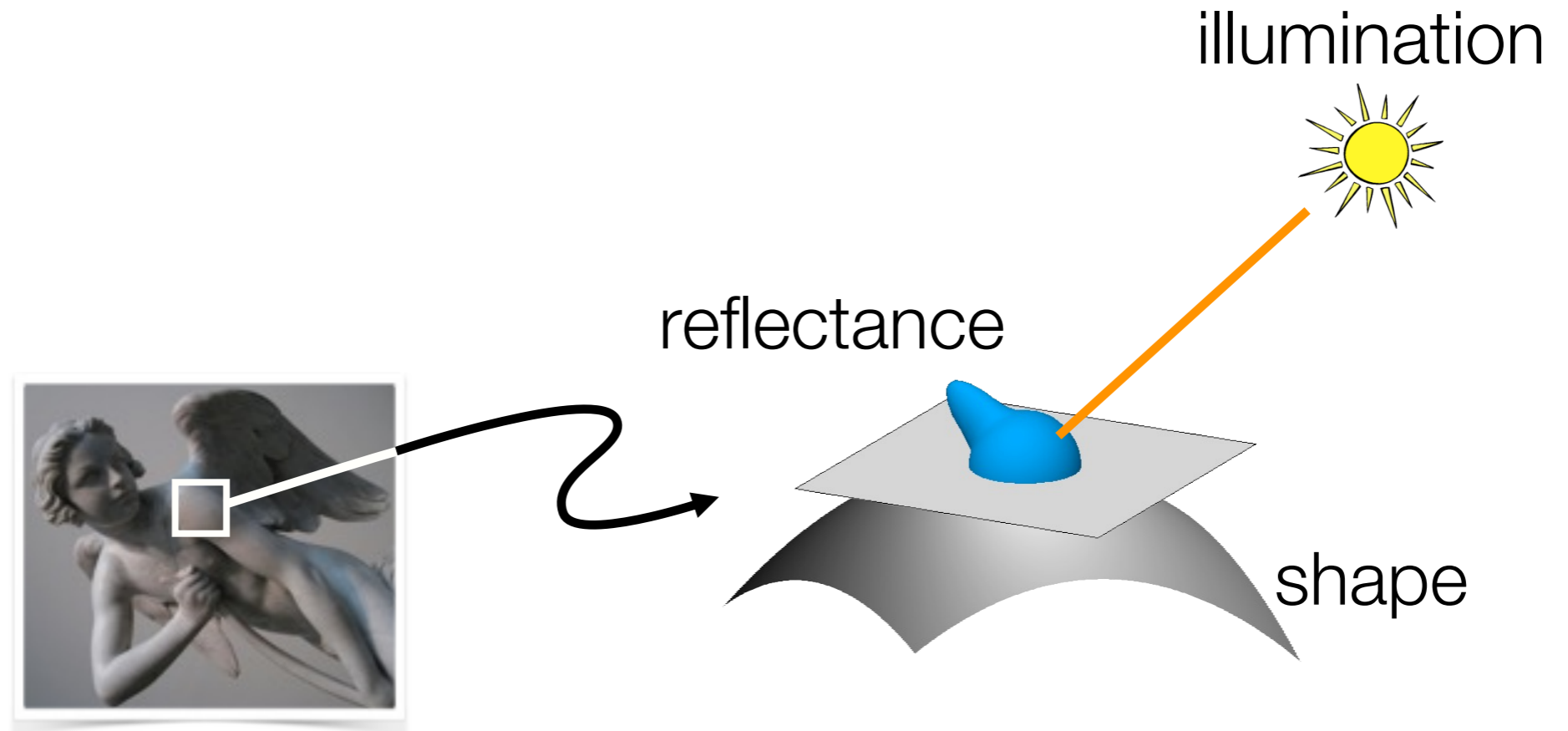

I \longrightarrow shape, illumination, reflectance

Reflectance and BRDF

Reflectance

- Ratio of outgoing energy to incoming energy at a single point
- Want to define a ratio such that it:
 - converges as we use smaller and smaller incoming and outgoing wedges
 - does not depend on the size of the wedges (i.e. is intrinsic to the material)

Reflectance

- Ratio of outgoing energy to incoming energy at a single point
- Want to define a ratio such that it:
 - converges as we use smaller and smaller incoming and outgoing wedges
 - does not depend on the size of the wedges (i.e. is intrinsic to the material)

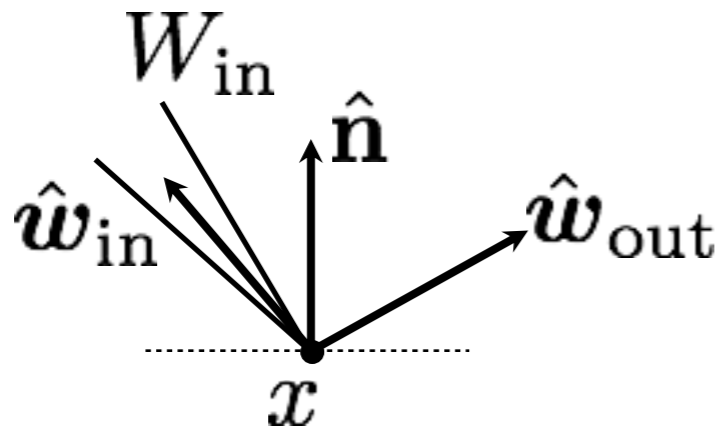

$$\lim_{W_{\text{in}} \rightarrow \hat{\omega}_{\text{in}}} f_{x, \hat{n}}(\hat{\omega}_{\text{in}}, \hat{\omega}_{\text{out}})$$

$$f_{x, \hat{n}}(W_{\text{in}}, \hat{\omega}_{\text{out}}) = \frac{L^{\text{out}}(x, \hat{\omega}_{\text{out}})}{E_{\hat{n}}^{\text{in}}(W_{\text{in}}, x)}$$

- Notations x and n often implied by context and omitted; directions ω are expressed in local coordinate system defined by normal n (and some chosen tangent vector)
- Units: sr^{-1}
- Called Bidirectional Reflectance Distribution Function (BRDF)

BRDF: Bidirectional Reflectance Distribution Function

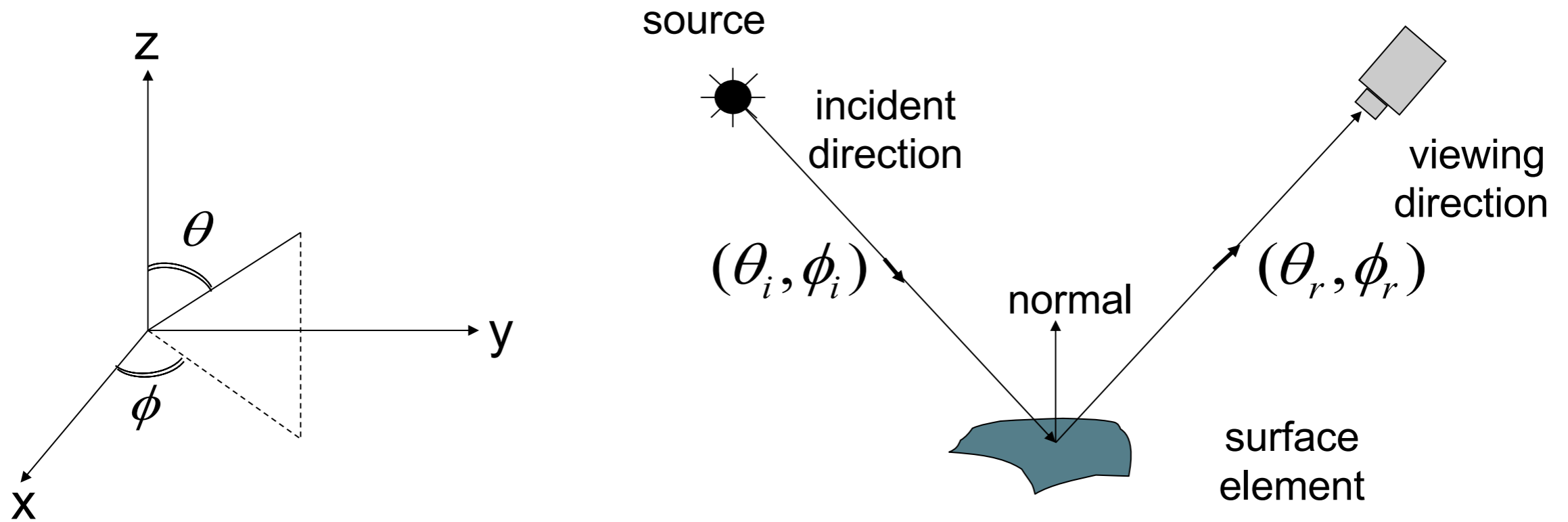

$E^{surface}(\theta_i, \phi_i)$ Irradiance at Surface in direction (θ_i, ϕ_i)

$L^{surface}(\theta_r, \phi_r)$ Radiance of Surface in direction (θ_r, ϕ_r)

$$\text{BRDF} : f(\theta_i, \phi_i; \theta_r, \phi_r) = \frac{L^{surface}(\theta_r, \phi_r)}{E^{surface}(\theta_i, \phi_i)}$$

Reflectance: BRDF

- Units: sr^{-1}
- Real-valued function defined on the double-hemisphere
- Has many useful properties

Important Properties of BRDFs

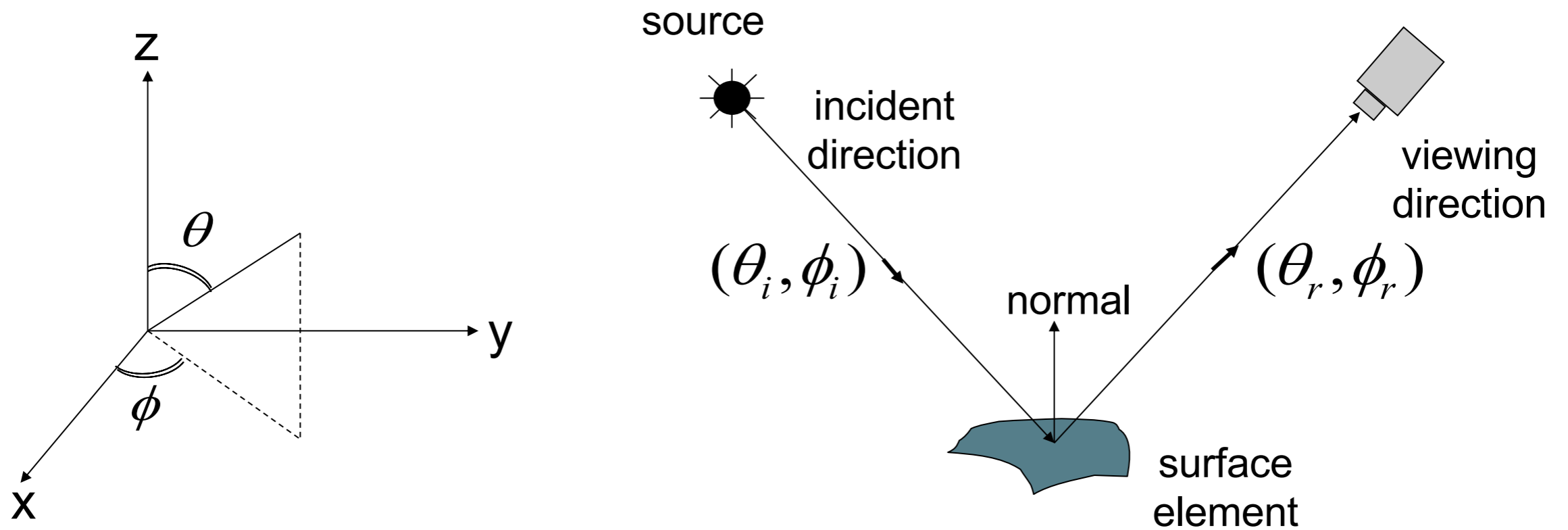

- Conservation of Energy:

$$\forall \hat{\omega}_{\text{in}}, \int_{\Omega_{\text{out}}} f(\hat{\omega}_{\text{in}}, \hat{\omega}_{\text{out}}) \cos \theta_{\text{out}} d\hat{\omega}_{\text{out}} \leq 1$$

Why smaller than or equal?

Property: “Helmholtz reciprocity”

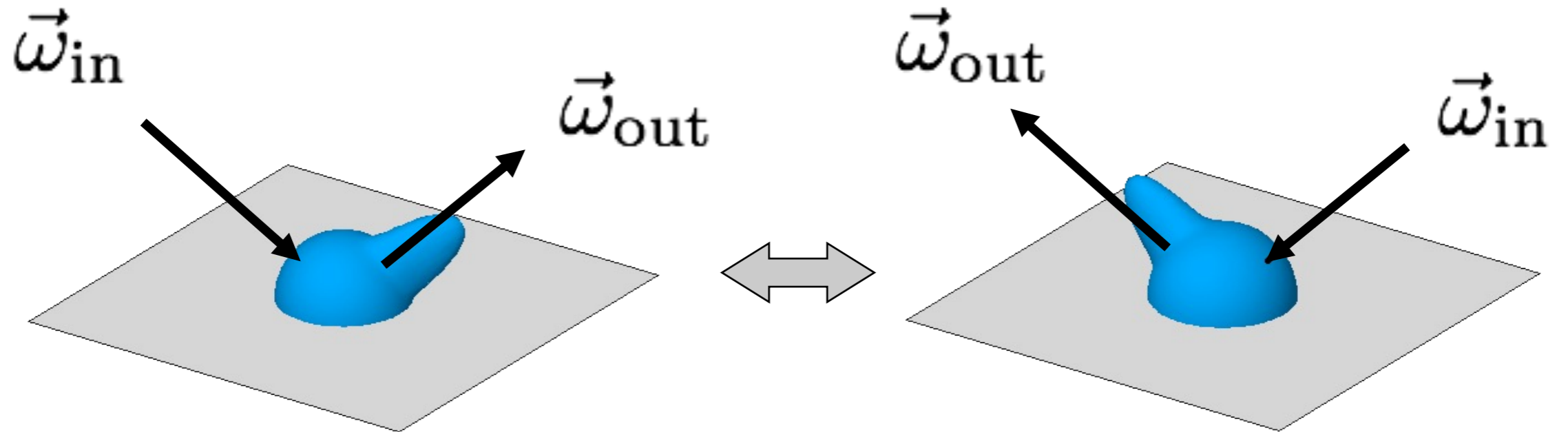

- **Helmholtz Reciprocity:** (follows from 2nd Law of Thermodynamics)
BRDF does not change when source and viewing directions are swapped.

$$f_r(\vec{\omega}_{in}, \vec{\omega}_{out}) = f_r(\vec{\omega}_{out}, \vec{\omega}_{in})$$

Common assumption: Isotropy

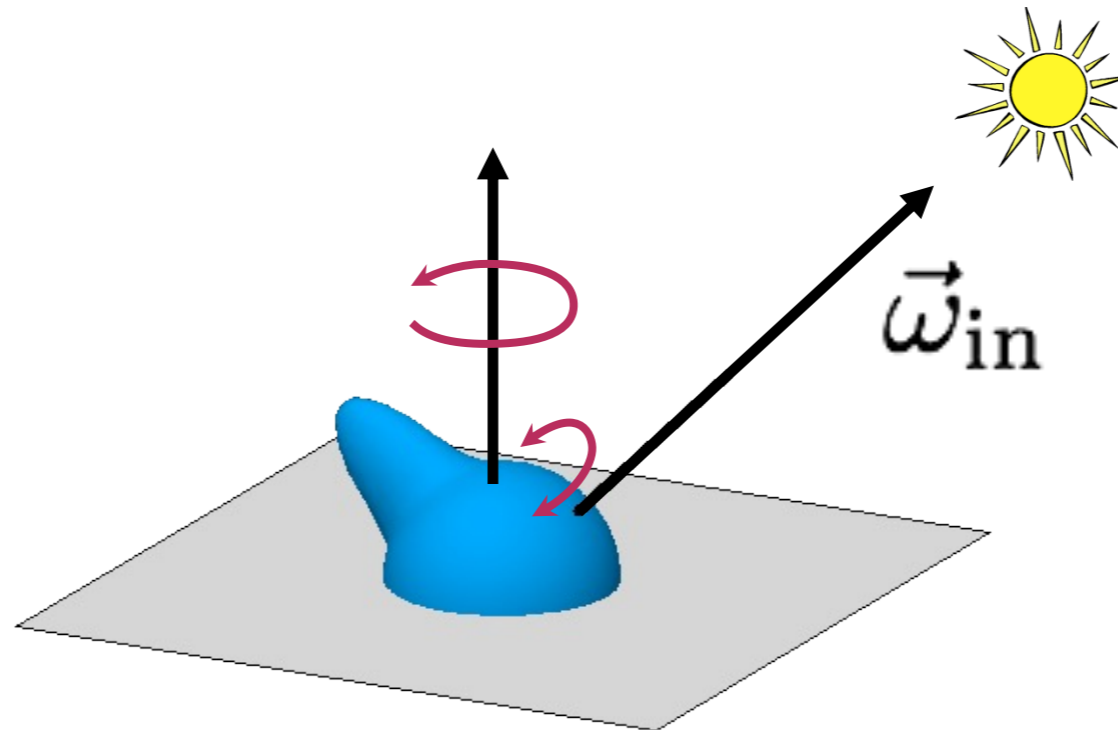
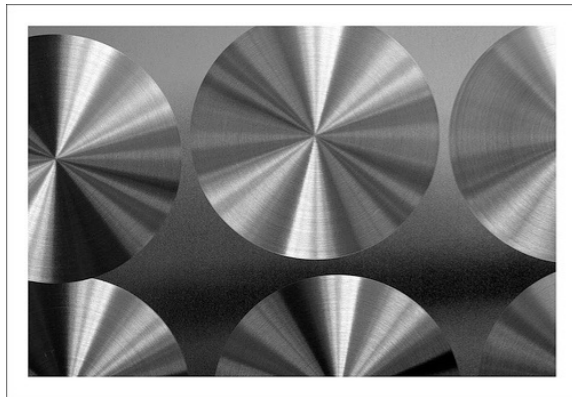

BRDF does not change when surface is rotated about the normal.

$$f_r(\vec{\omega}_{in}, \cdot)$$

4D → 3D

$$f_r(\vec{\omega}_{in}, \vec{\omega}_{out})$$

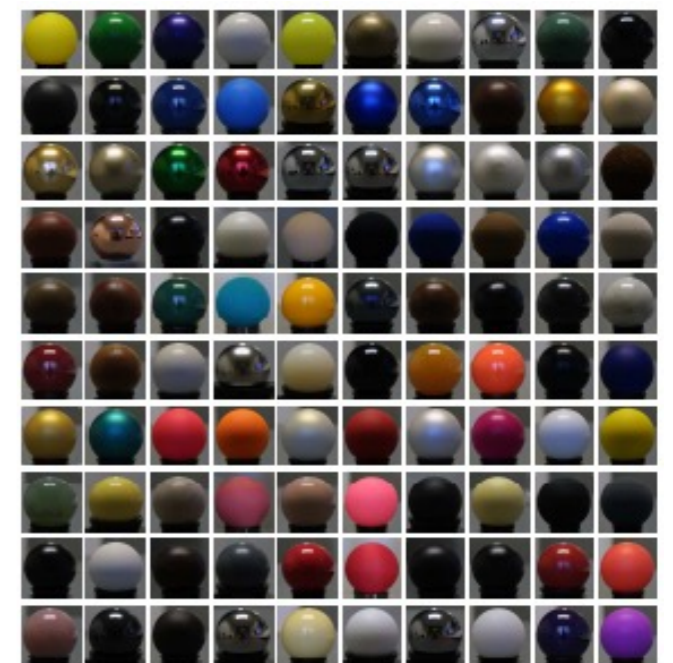

[Matusik et al., 2003]

Bi-directional Reflectance Distribution Function (BRDF)

Can be written as a function of 3 variables : $f(\theta_i, \theta_r, \phi_i - \phi_r)$

Reflectance: BRDF

- Units: sr^{-1}
- Real-valued function defined on the double-hemisphere
- Has many useful properties
- Allows computing output radiance (and thus pixel value) for *any* configuration of lights and viewpoint

$$L^{\text{out}}(\hat{\omega}) = \int_{\Omega_{\text{in}}} f(\hat{\omega}_{\text{in}}, \hat{\omega}_{\text{out}}) L^{\text{in}}(\hat{\omega}_{\text{in}}) \cos \theta_{\text{in}} d\hat{\omega}_{\text{in}}$$

reflectance equation

Why is there a cosine in the reflectance equation?

Derivation of the Reflectance Equation

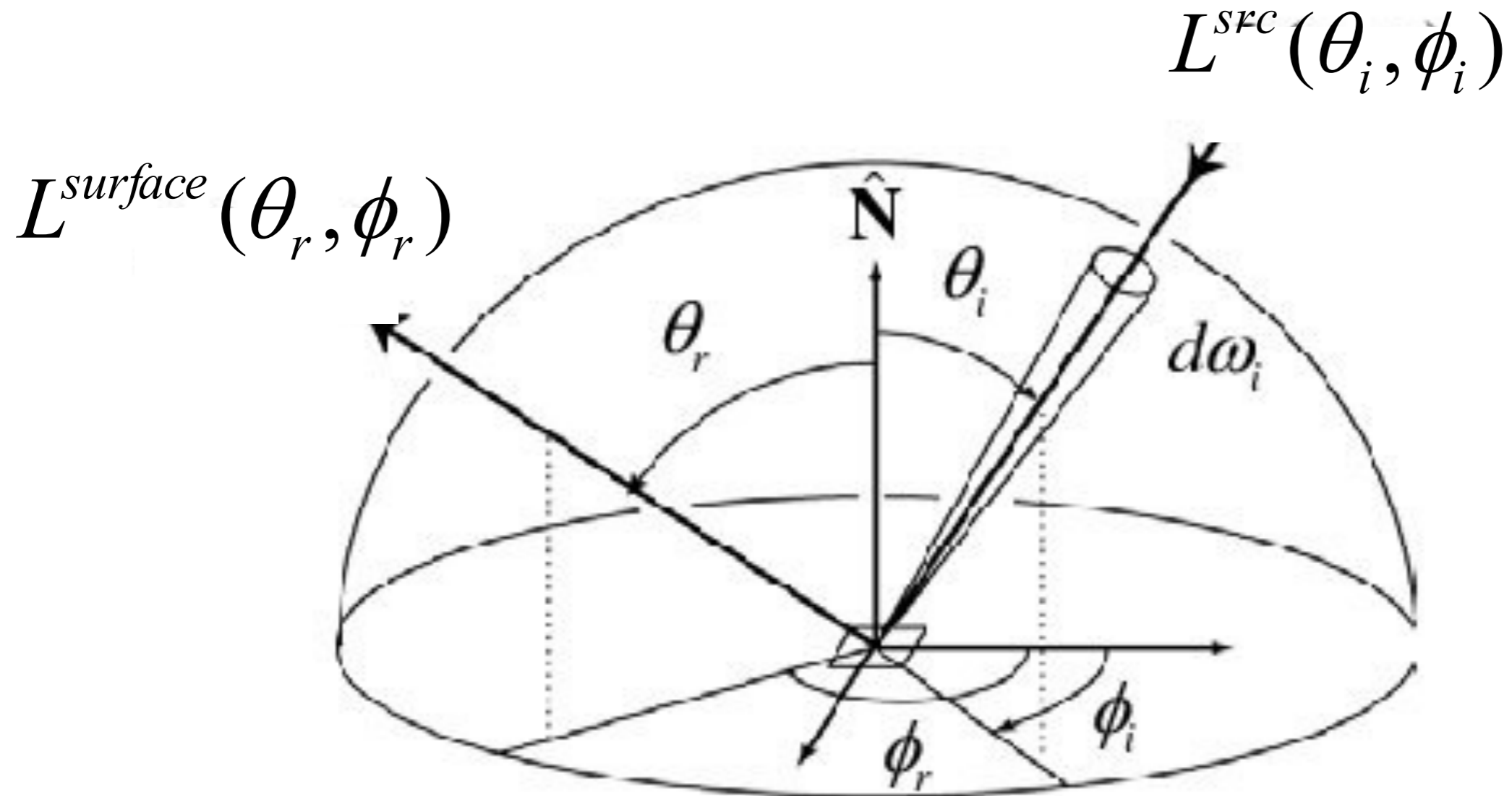

From the definition of BRDF:

$$L^{surface}(\theta_r, \phi_r) = E^{surface}(\theta_i, \phi_i) f(\theta_i, \phi_i; \theta_r, \phi_r)$$

Derivation of the Scene Radiance Equation

From the definition of BRDF:

$$L^{surface}(\theta_r, \phi_r) = \frac{E^{surface}(\theta_i, \phi_i) f(\theta_i, \phi_i; \theta_r, \phi_r)}{}$$

Write Surface Irradiance in terms of Source Radiance:

$$L^{surface}(\theta_r, \phi_r) = \frac{L^{src}(\theta_i, \phi_i) f(\theta_i, \phi_i; \theta_r, \phi_r) \cos \theta_i d\omega_i}{}$$

Integrate over entire hemisphere of possible source directions:

$$L^{surface}(\theta_r, \phi_r) = \int_{2\pi} L^{src}(\theta_i, \phi_i) f(\theta_i, \phi_i; \theta_r, \phi_r) \cos \theta_i \underline{d\omega_i}$$

Convert from solid angle to theta-phi representation:

$$L^{surface}(\theta_r, \phi_r) = \int_{-\pi}^{\pi} \int_0^{\pi/2} L^{src}(\theta_i, \phi_i) f(\theta_i, \phi_i; \theta_r, \phi_r) \cos \theta_i \underline{\sin \theta_i d\theta_i d\phi_i}$$

Differential Solid Angles

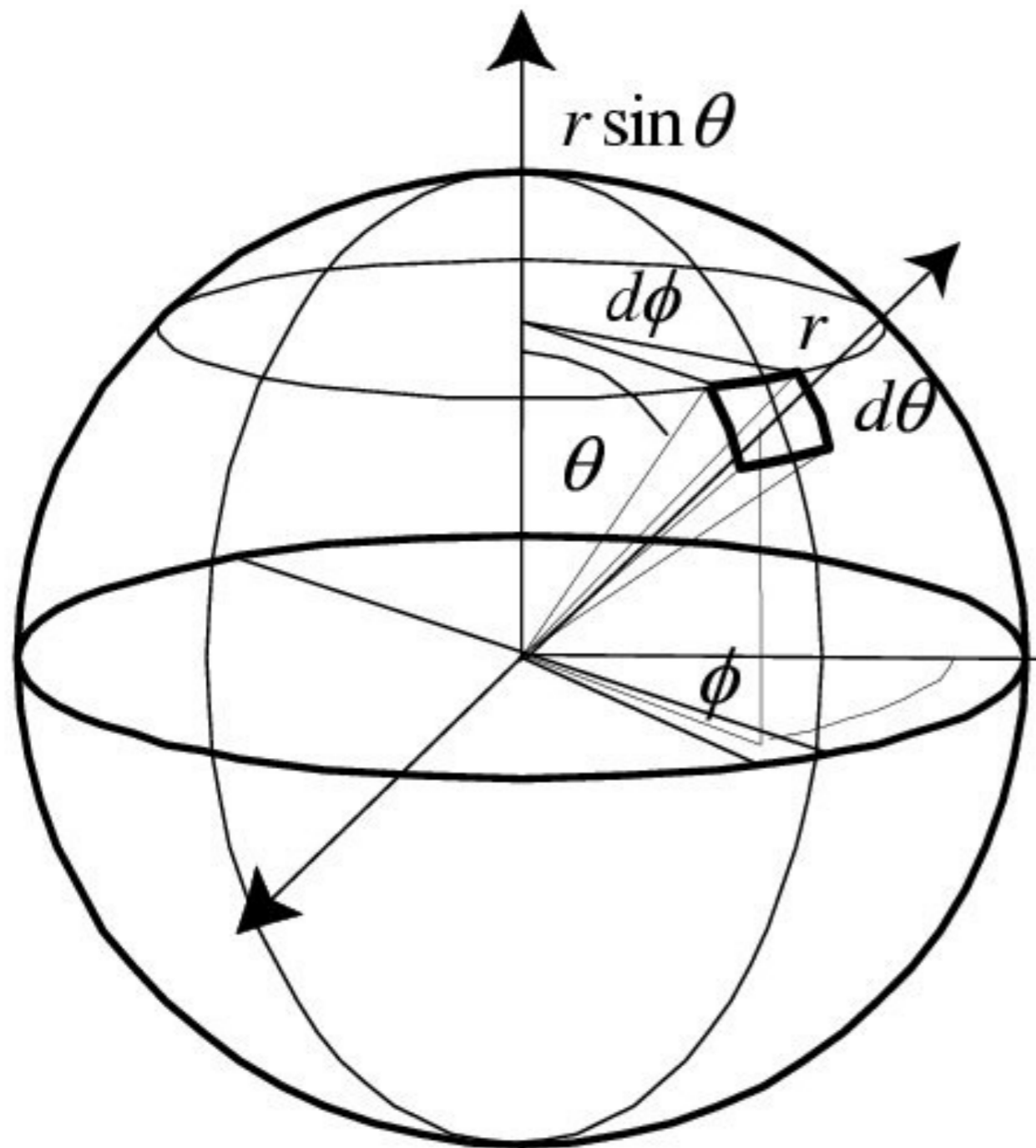

$$\begin{aligned}dA &= (r d\theta)(r \sin \theta d\phi) \\ &= r^2 \sin \theta d\theta d\phi\end{aligned}$$

$$d\omega = \frac{dA}{r^2} = \sin \theta d\theta d\phi$$

$$S = \int_0^{\pi} \int_0^{2\pi} \sin \theta d\theta d\phi = 4\pi$$

BRDF

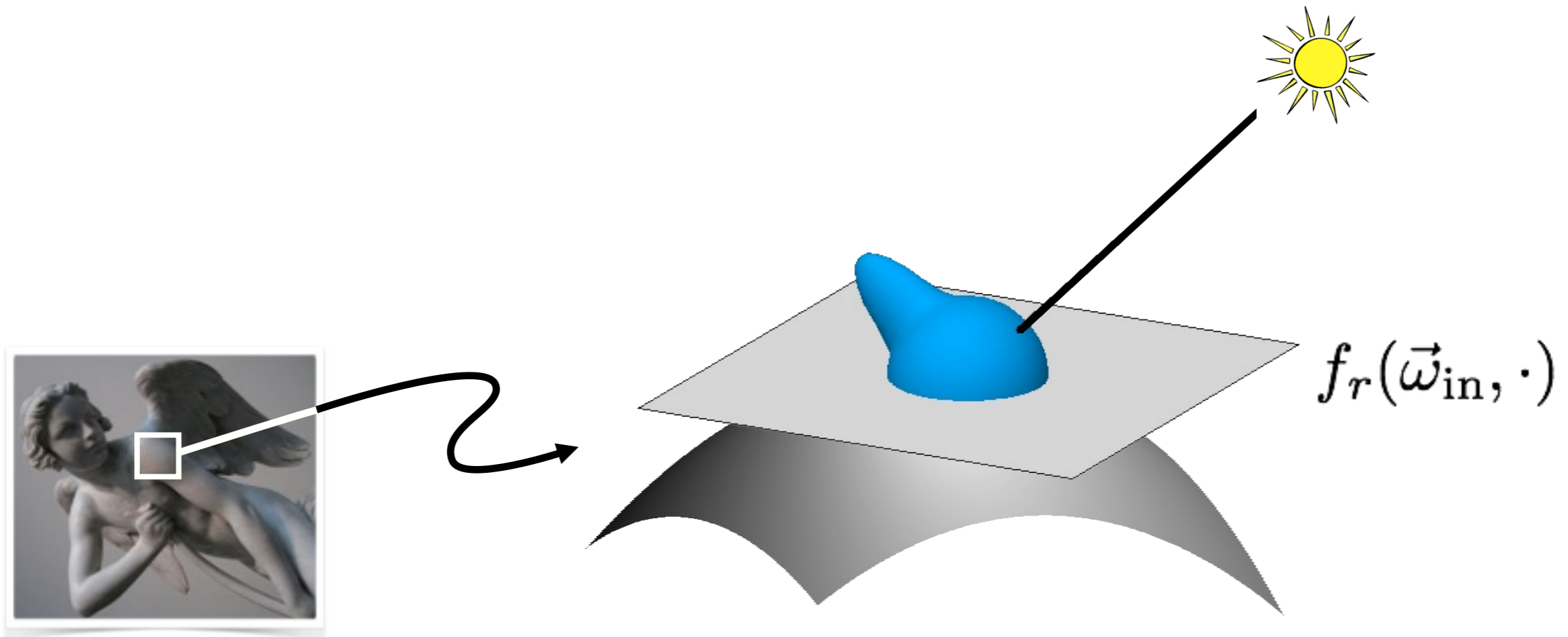

$$f_r(\vec{\omega}_{in}, \vec{\omega}_{out})$$

Bi-directional Reflectance Distribution Function (BRDF)

BRDF

Lambertian (diffuse) BRDF: energy equally distributed in all directions

What does the BRDF equal in this case?

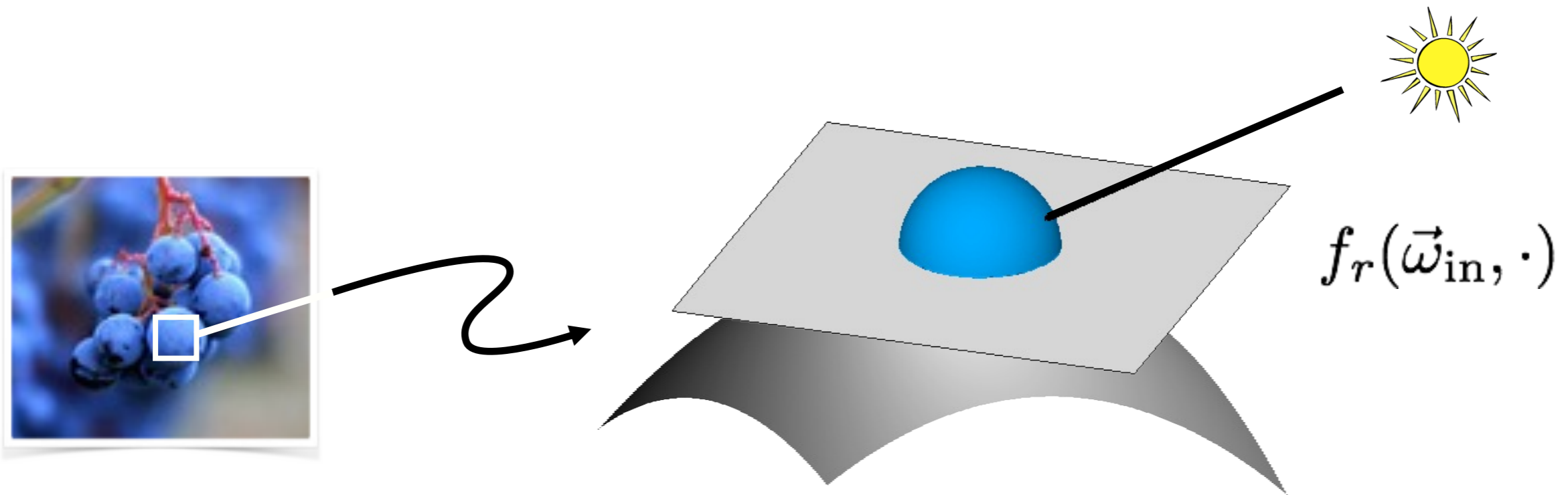

$$f_r(\vec{\omega}_{in}, \vec{\omega}_{out})$$

Bi-directional Reflectance Distribution Function (BRDF)

Diffuse Reflection and Lambertian BRDF

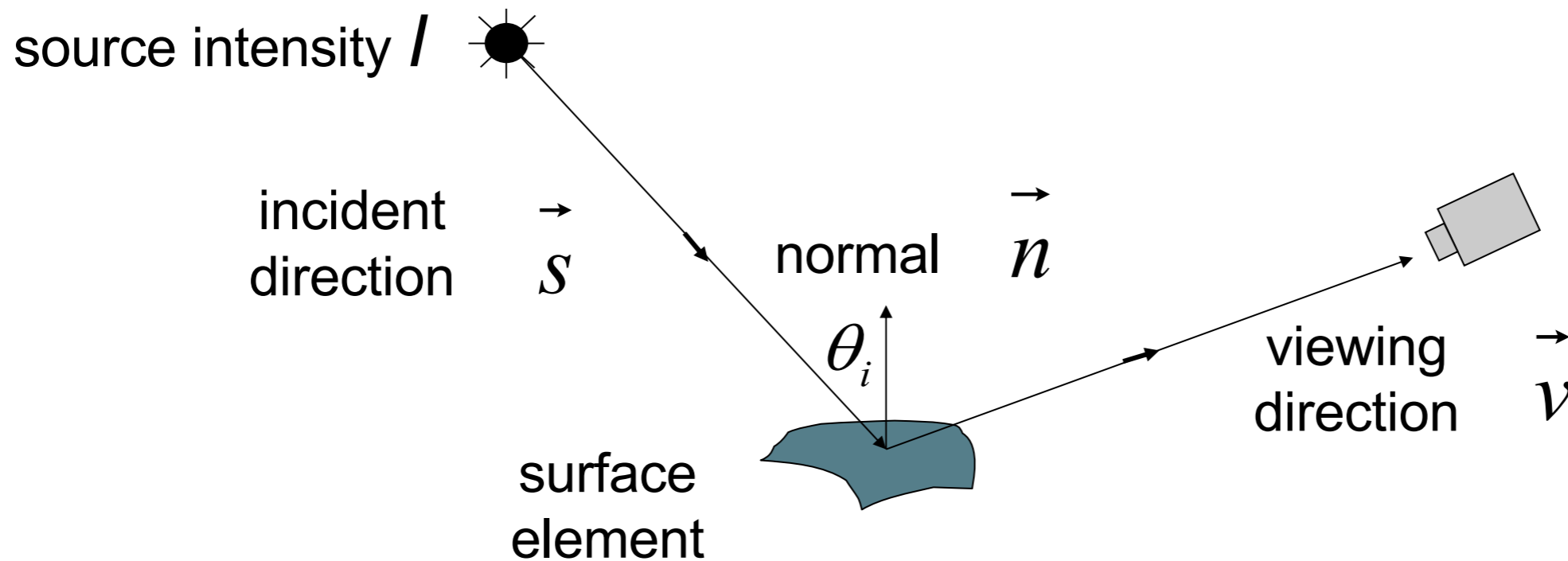

- Surface appears equally bright from ALL directions! (independent of \vec{v})
- Lambertian BRDF is simply a constant : $f(\theta_i, \phi_i; \theta_r, \phi_r) = \frac{\rho_d}{\pi}$ albedo
- Most commonly used BRDF in Vision and Graphics!

BRDF

Specular BRDF: all energy concentrated in mirror direction

What does the BRDF equal in this case?

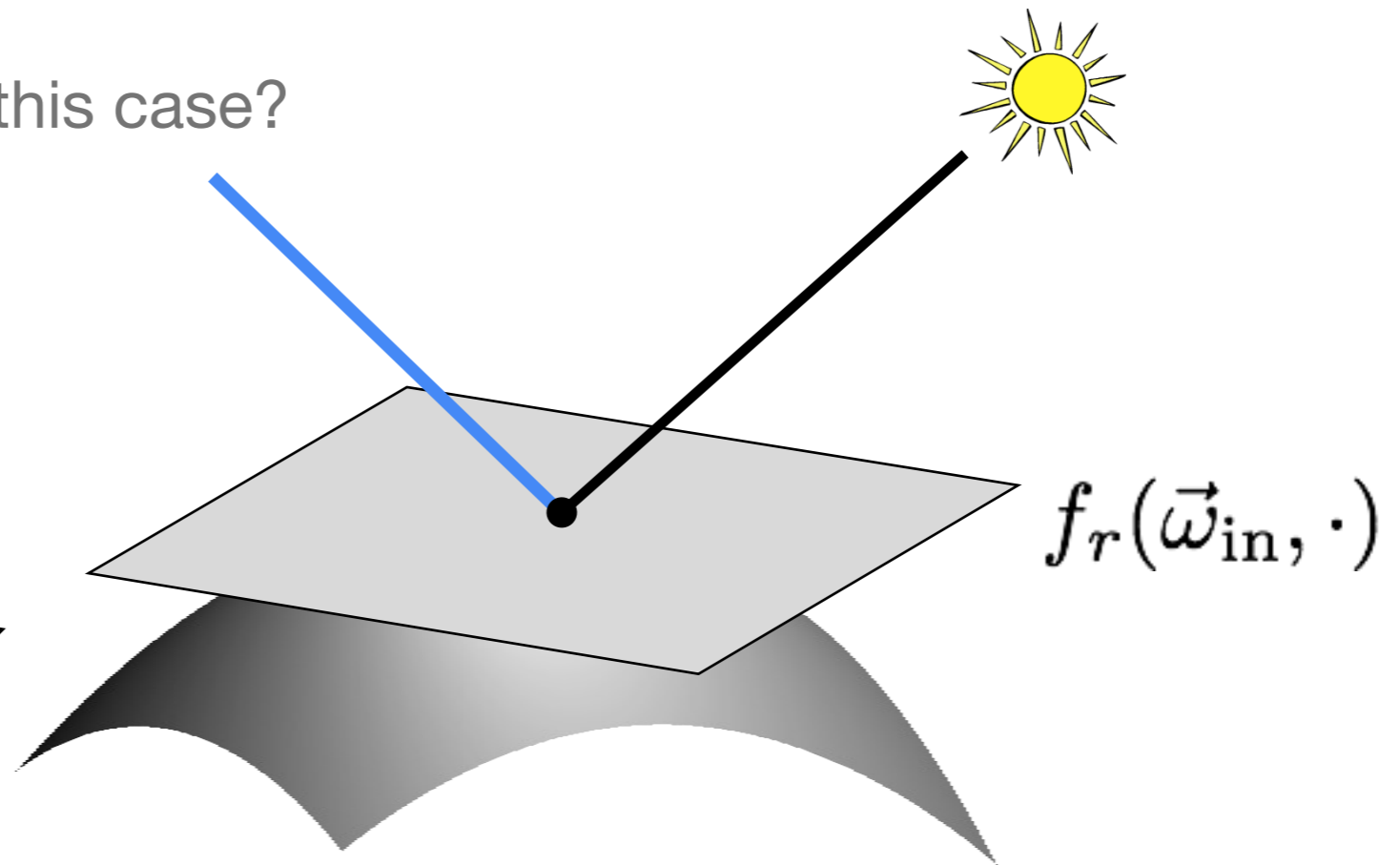

$$f_r(\vec{\omega}_{in}, \vec{\omega}_{out})$$

Bi-directional Reflectance Distribution Function (BRDF)

Specular Reflection and Mirror BRDF

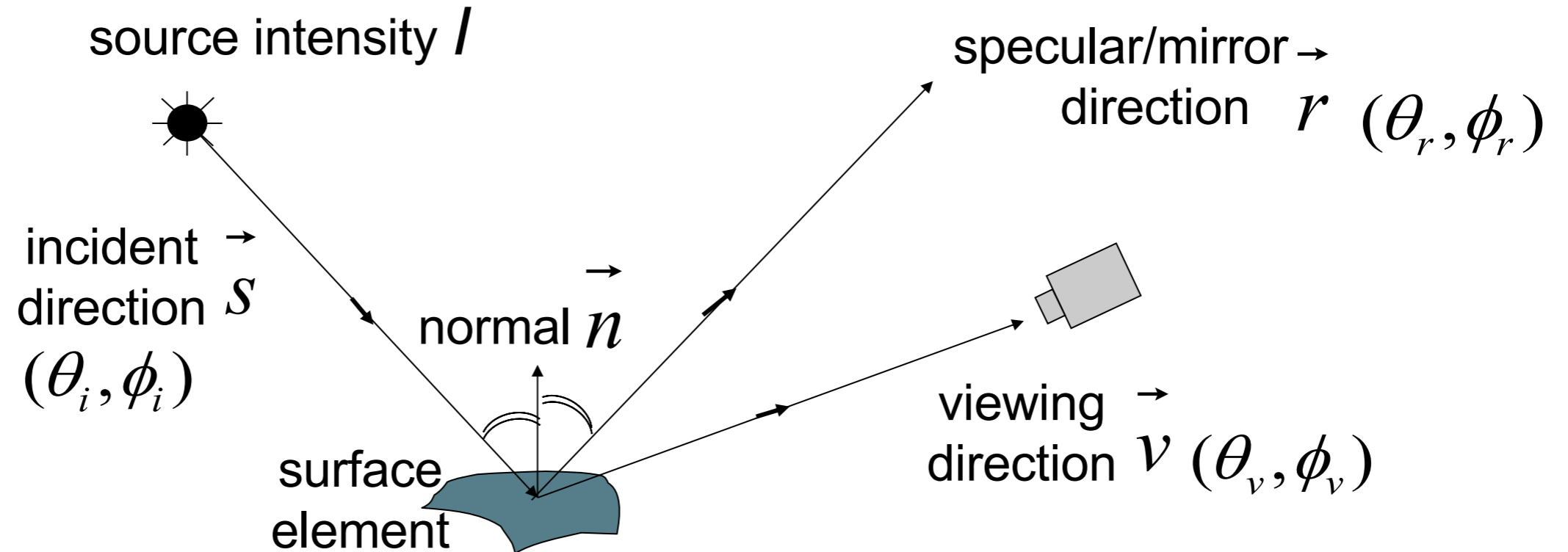

- Valid for very smooth surfaces.
- All incident light energy reflected in a SINGLE direction (only when $\vec{v} = \vec{r}$).
- Mirror BRDF is simply a double-delta function :

$$f(\theta_i, \phi_i; \theta_v, \phi_v) = \rho_s \delta(\theta_i - \theta_v) \delta(\phi_i + \pi - \phi_v)$$

Example Surfaces

Body Reflection:

Diffuse Reflection
Matte Appearance
Non-Homogeneous Medium
Clay, paper, etc



Surface Reflection:

Specular Reflection
Glossy Appearance
Highlights
Dominant for Metals



Many materials exhibit
both Reflections:



BRDF

Glossy BRDF: more energy concentrated in mirror direction than elsewhere

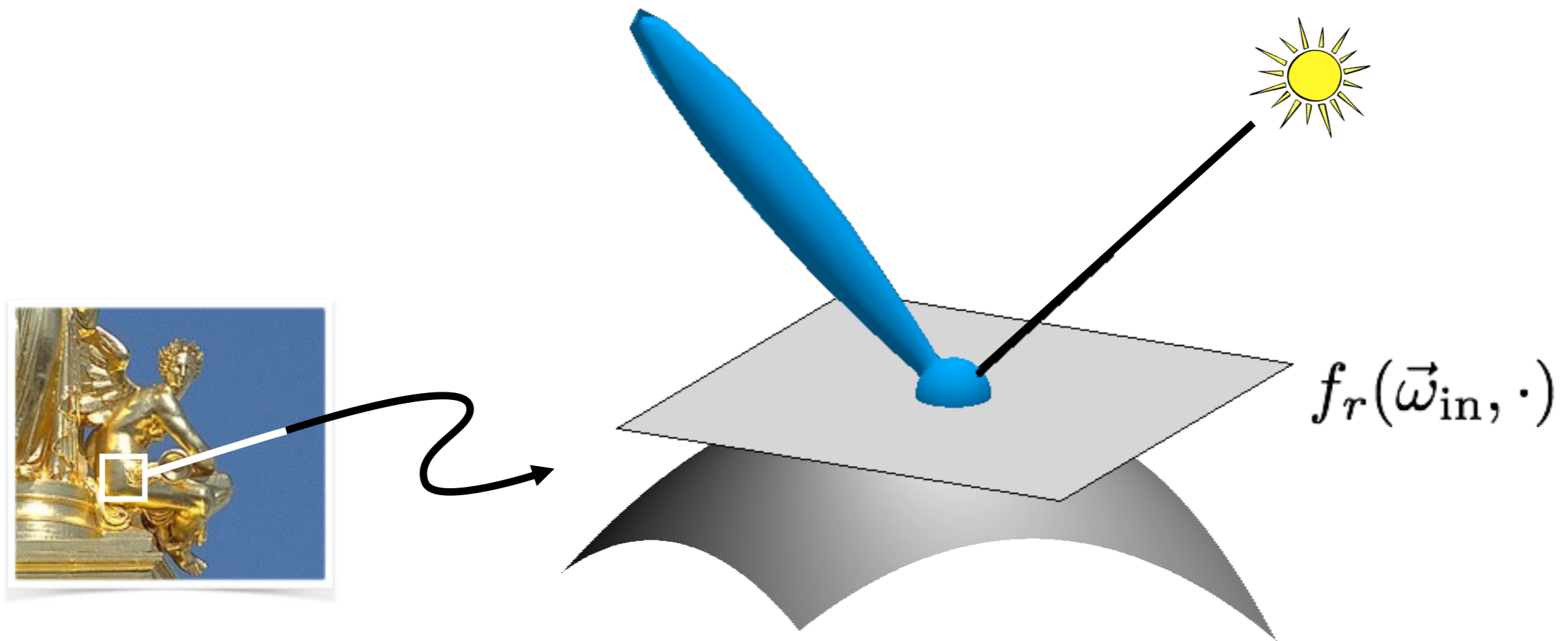

$$f_r(\vec{\omega}_{in}, \vec{\omega}_{out})$$

Bi-directional Reflectance Distribution Function (BRDF)

Trick for dielectrics (non-metals)

- BRDF is a sum of a Lambertian diffuse component and non-Lambertian specular components
- The two components differ in terms of color and polarization, and under certain conditions, this can be exploited to separate them.

$$f(\vec{\omega}_i, \vec{\omega}_o) = f_d + f_s(\vec{\omega}_i, \vec{\omega}_o)$$

Trick for dielectrics (non-metals)

- BRDF is a sum of a Lambertian diffuse component and non-Lambertian specular components
- The two components differ in terms of color and polarization, and under certain conditions, this can be exploited to separate them.

$$f(\vec{\omega}_i, \vec{\omega}_o) = f_d + f_s(\vec{\omega}_i, \vec{\omega}_o)$$

Often called the *dichromatic BRDF*:

- Diffuse term varies with wavelength, constant with polarization
- Specular term constant with wavelength, varies with polarization

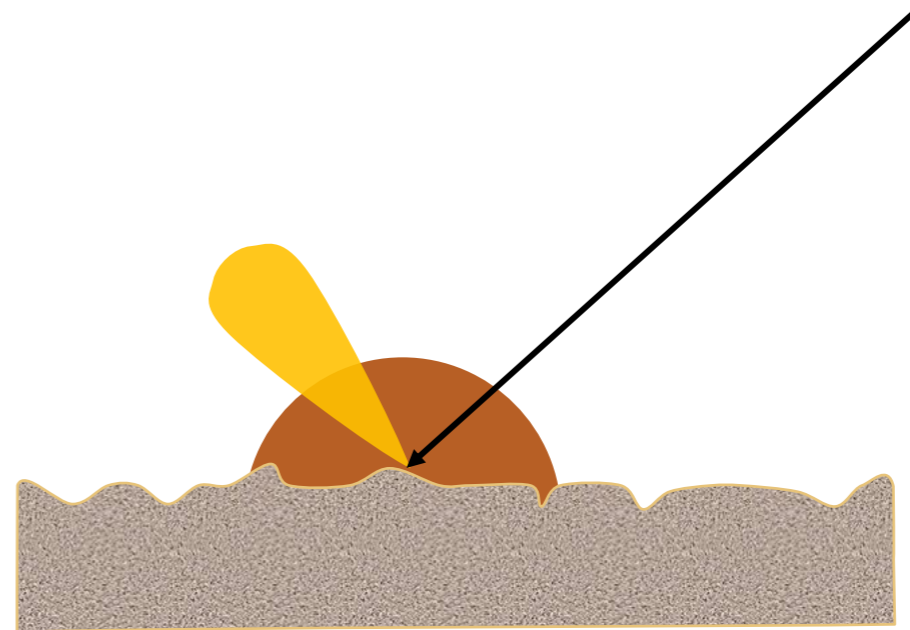

Trick for dielectrics (non-metals)

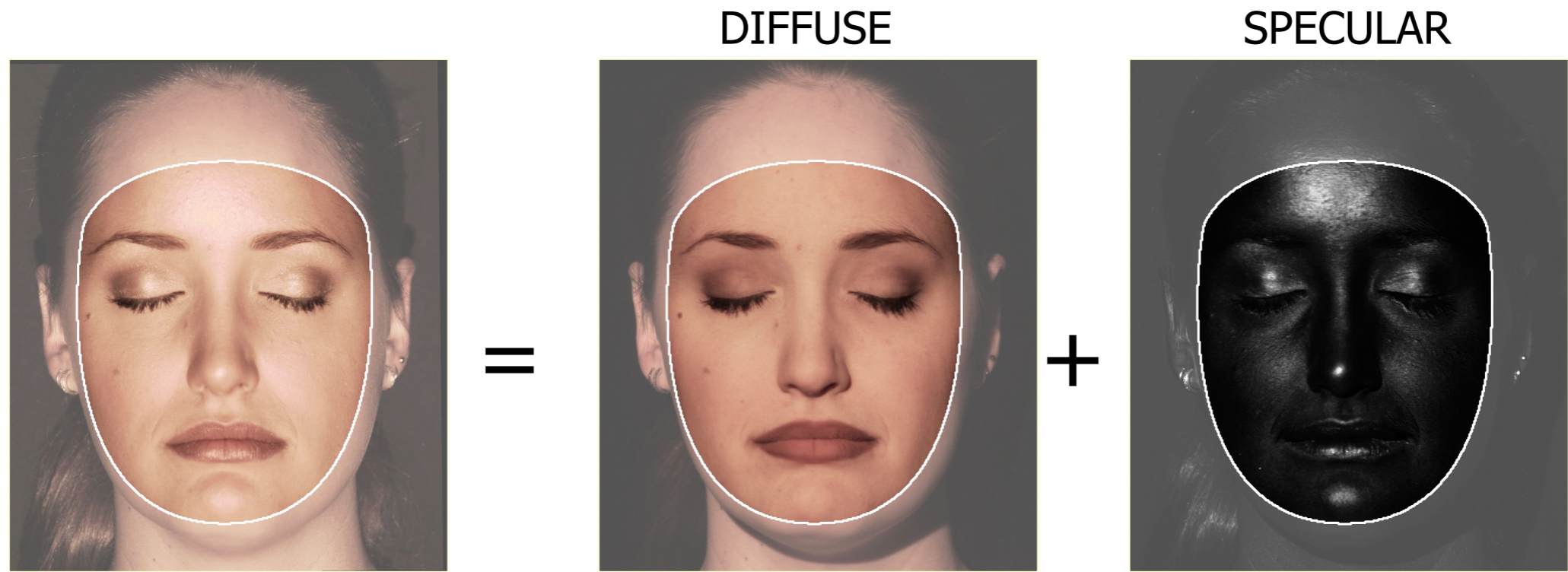

- In this example, the two components were separated using linear polarizing filters on the camera and light source.

Tabulated 4D BRDFs (hard to measure)

Cylinder (1D normal variation)
with stripes of the material
at different orientations (1D)

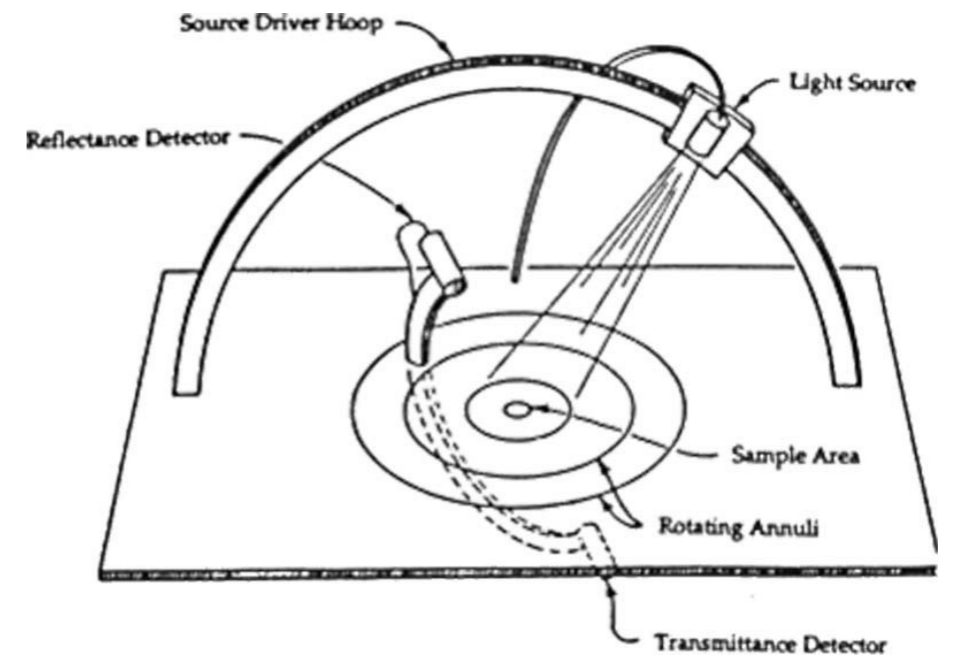
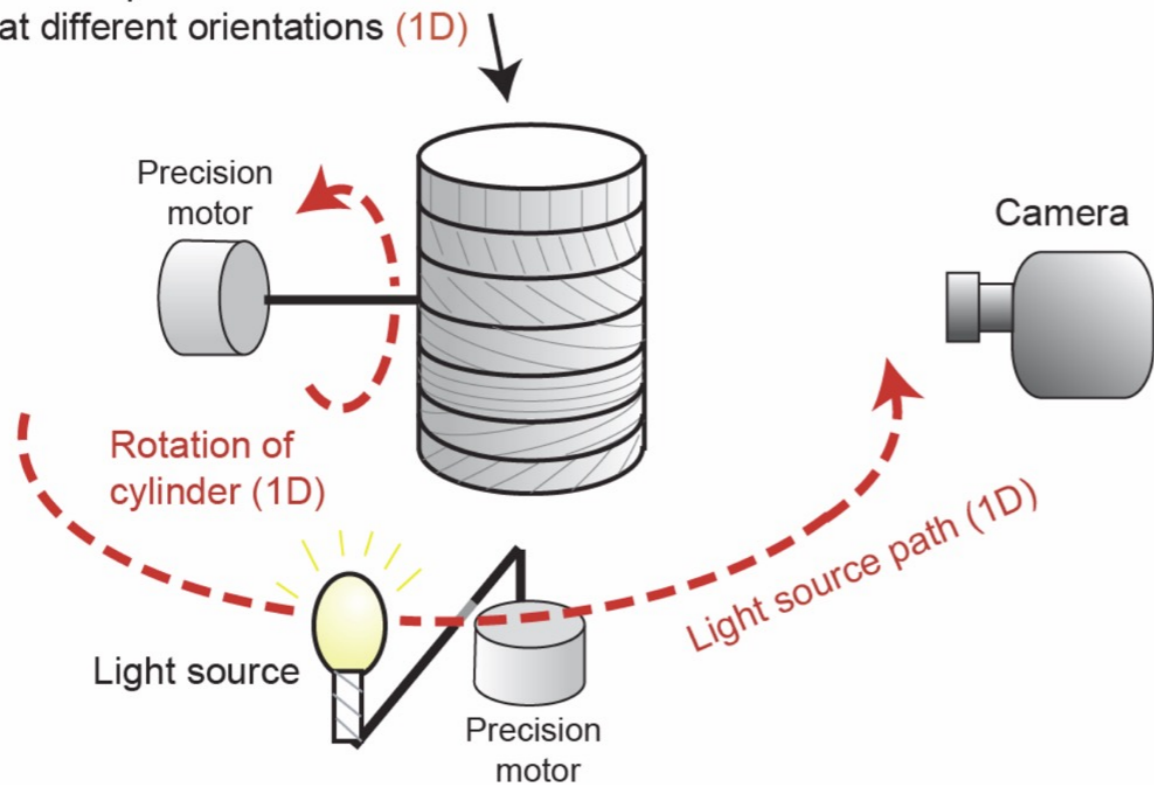

Gonioreflectometer



[Ngan et al., 2005]

Low-parameter (non-linear) BRDF models

- A small number of parameters define the (2D,3D, or 4D) function
- Except for Lambertian, the BRDF is non-linear in these parameters
- Examples:

Lambertian: $f(\omega_i, \omega_o) = \frac{a}{\pi}$ ← Where do these constants come from?

Phong: $f(\omega_i, \omega_o) = \frac{a}{\pi} + b \cos^c (2\langle \omega_i, n \rangle \langle \omega_o, n \rangle - \langle \omega_i, \omega_o \rangle)$

Blinn: $f(\omega_i, \omega_o) = \frac{a}{\pi} + b \cos^c b(\omega_i, \omega_o)$

Lafortune: $f(\omega_i, \omega_o) = \frac{a}{\pi} + b(-\omega_i^\top A \omega_o)^k$

Ward: $f(\omega_i, \omega_o) = \frac{a}{\pi} + \frac{b}{4\pi c^2 \sqrt{\langle n, \omega_i \rangle \langle n, \omega_o \rangle}} \exp\left(\frac{-\tan^2 b(\omega_i, \omega_o)}{c^2}\right)$

a is called the *albedo*

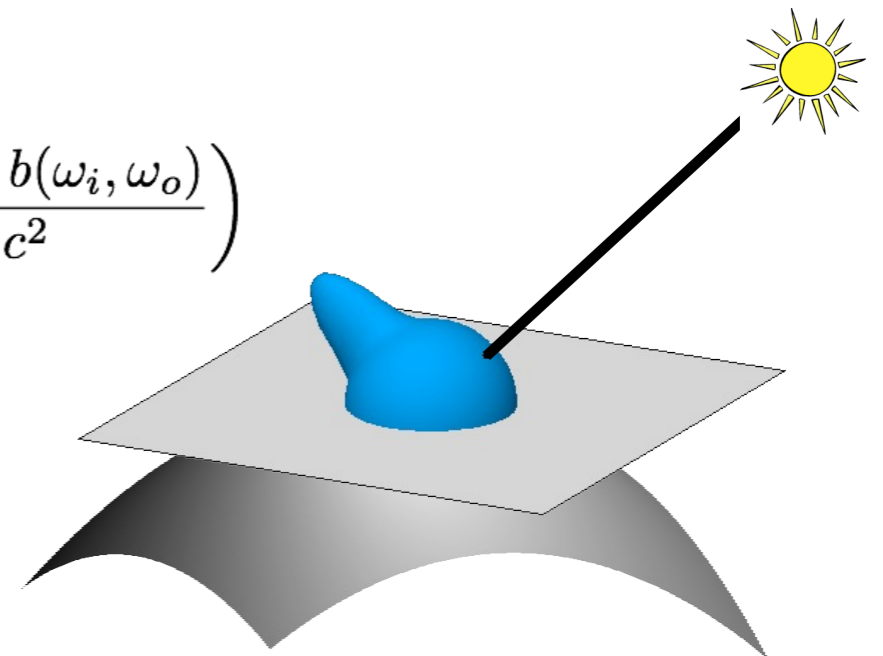

Reflectance Models

Reflection: An Electromagnetic Phenomenon

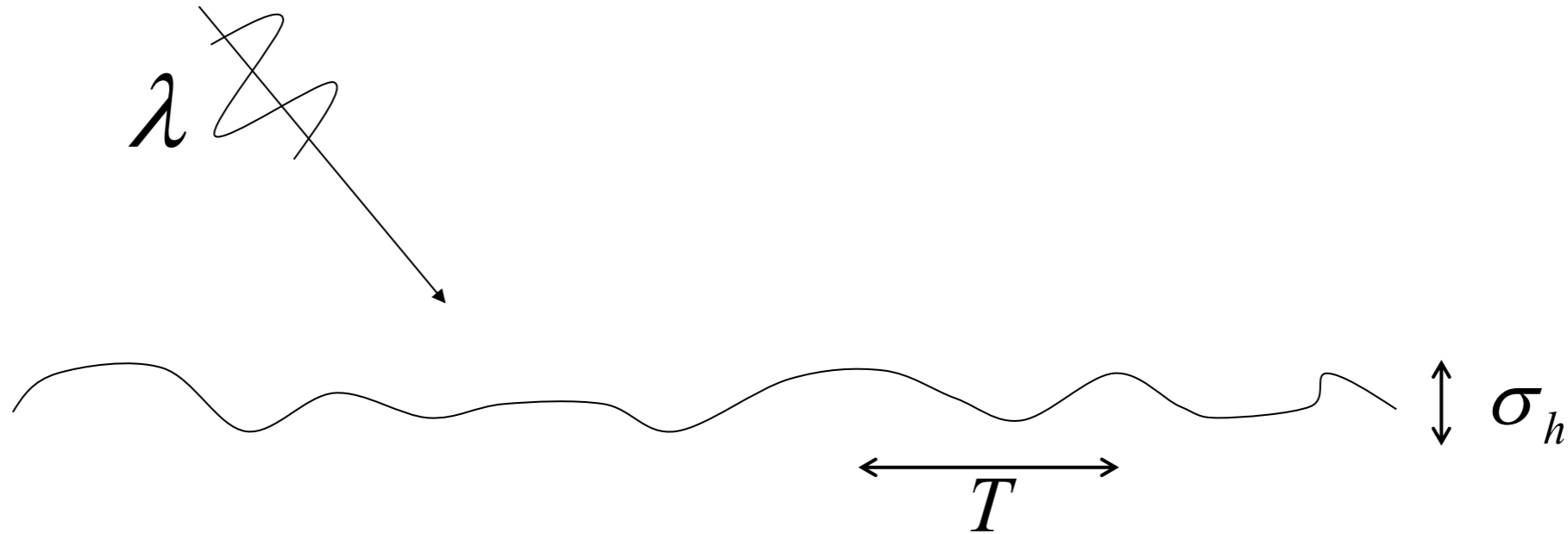

Two approaches to derive Reflectance Models:

- Physical Optics (Wave Optics)
- Geometrical Optics (Ray Optics)

Geometrical models are approximations to physical models

But they are easier to use!

Reflectance that Require Wave Optics

