

Photometric stereo



Overview of today's lecture

- Some notes about radiometry.
- Quick overview of the n-dot-l model.
- Photometric stereo.
- Uncalibrated photometric stereo.
- Generalized bas-relief ambiguity.
- Shape from shading.

Slide credits

Many of these slides were adapted from:

- Srinivasa Narasimhan (16-385, Spring 2014).
- Todd Zickler (Harvard University).
- Steven Gortler (Harvard University).
- Kayvon Fatahalian (Stanford University; CMU 15-462, Fall 2015).

Quick overview of radiometry

Five important equations/integrals to remember

Flux measured by a sensor of area X and directional receptivity W :

$$\Phi(W, X) = \int_X \int_W L(\hat{\omega}, x) \cos \theta d\omega dA$$

Reflectance equation:

$$L^{\text{out}}(\hat{\omega}) = \int_{\Omega_{\text{in}}} f(\hat{\omega}_{\text{in}}, \hat{\omega}_{\text{out}}) L^{\text{in}}(\hat{\omega}_{\text{in}}) \cos \theta_{\text{in}} d\hat{\omega}_{\text{in}}$$

Radiance under directional lighting and Lambertian BRDF (“n-dot-l shading”):

$$L^{\text{out}} = a \hat{\mathbf{n}}^T \vec{\ell}$$

Conversion of a (hemi)-spherical integral to a surface integral:

$$\int_{H^2} L_i(p, \omega', t) \cos \theta d\omega' = \int_A L(p' \rightarrow p, t) \frac{\cos \theta \cos \theta'}{\|p' - p\|^2} dA'$$

Computing (hemi)-spherical integrals:

$$d\omega = \frac{dA}{r^2} = \sin \theta d\theta d\phi \quad \text{and} \quad \int d\omega = \int_0^\pi \int_0^{2\pi} \sin \theta d\theta d\phi$$

Quiz 1: Measurement of a sensor using a thin lens

Lens aperture



Sensor plane



What integral should we write for the power measured by infinitesimal pixel p ?

Quiz 1: Measurement of a sensor using a thin lens

Lens aperture



Sensor plane



What integral should we write for the power measured by infinitesimal pixel p ?

$$E(p, t) = \int_{H^2} L_i(p, \omega', t) \cos \theta \, d\omega'$$

Can I transform this integral over the hemisphere to an integral over the aperture area?

Quiz 1: Measurement of a sensor using a thin lens

Lens aperture

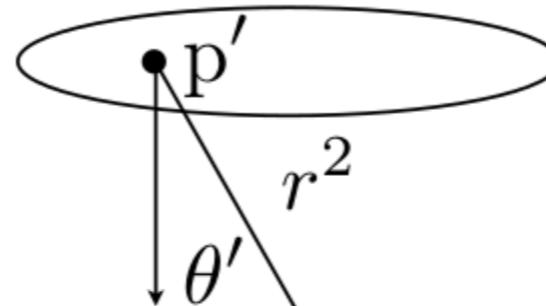

Sensor plane



What integral should we write for the power measured by infinitesimal pixel p ?

$$E(p, t) = \int_{H^2} L_i(p, \omega', t) \cos \theta \, d\omega'$$

Can I transform this integral over the hemisphere to an integral over the aperture area?

$$E(p, t) = \int_A L(p' \rightarrow p, t) \frac{\cos \theta \cos \theta'}{\|p' - p\|^2} \, dA'$$

Transform integral over solid angle to integral over lens aperture

Quiz 1: Measurement of a sensor using a thin lens

Lens aperture

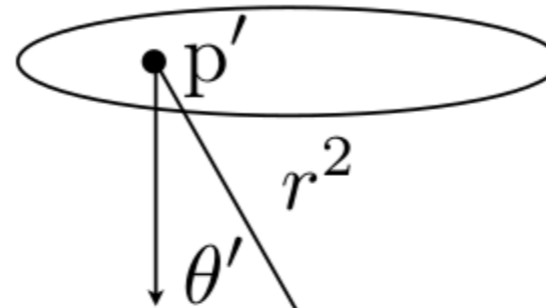

Sensor plane



$$E(p, t) = \int_A L(p' \rightarrow p, t) \frac{\cos \theta \cos \theta'}{\|p' - p\|^2} dA'$$
$$= \int_A L(p' \rightarrow p, t) \frac{\cos^2 \theta}{\|p' - p\|^2} dA'$$

Transform integral over solid angle to integral over lens aperture

Assume aperture and film plane are parallel: $\theta = \theta'$

Can I write the denominator in a more convenient form?

Quiz 1: Measurement of a sensor using a thin lens

Lens aperture

$$\|p' - p\| = \frac{d}{\cos \theta}$$

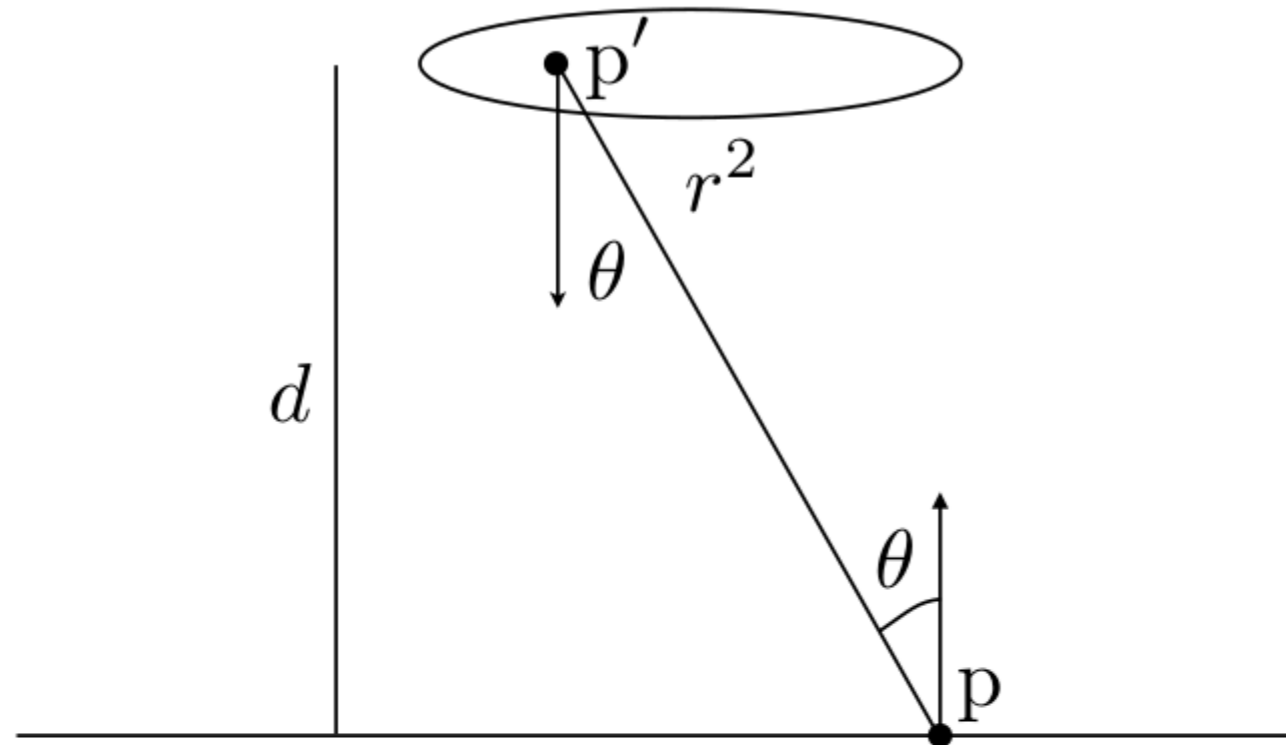

Sensor plane

$$\begin{aligned} E(p, t) &= \int_A L(p' \rightarrow p, t) \frac{\cos^2 \theta}{\|p' - p\|^2} dA' \\ &= \frac{1}{d^2} \int_A L(p' \rightarrow p, t) \cos^4 \theta dA' \end{aligned}$$

What does this say about the image I am capturing?

Vignetting

Fancy word for: pixels far off the center receive less light



white wall under uniform light



more interesting example of vignetting

Four types of vignetting:

- Mechanical: light rays blocked by hoods, filters, and other objects.
- Lens: similar, but light rays blocked by lens elements.
- Natural: due to radiometric laws (“cosine fourth falloff”).
- Pixel: angle-dependent sensitivity of photodiodes.

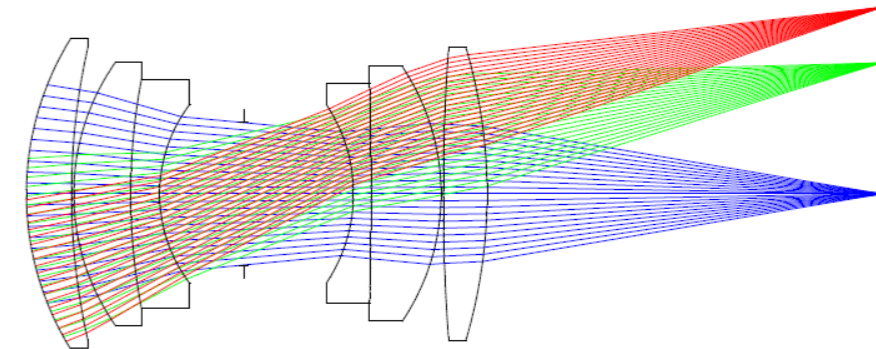

Quiz 2: BRDF of the moon

What BRDF does the moon have?

Quiz 2: BRDF of the moon

What BRDF does the moon have?

- Can it be diffuse?

Quiz 2: BRDF of the moon

What BRDF does the moon have?

- Can it be diffuse?

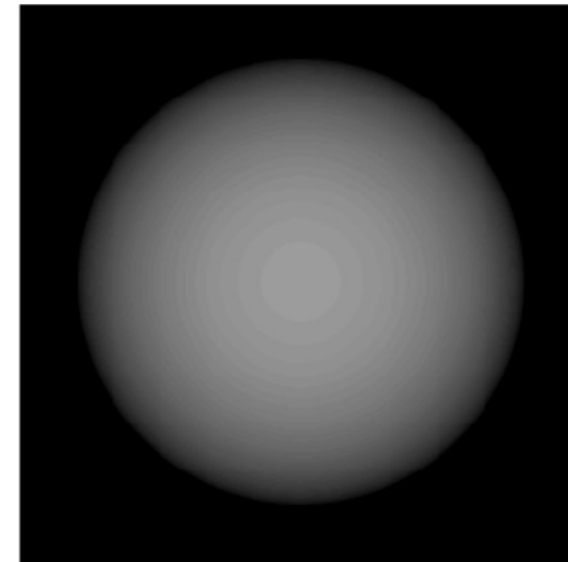
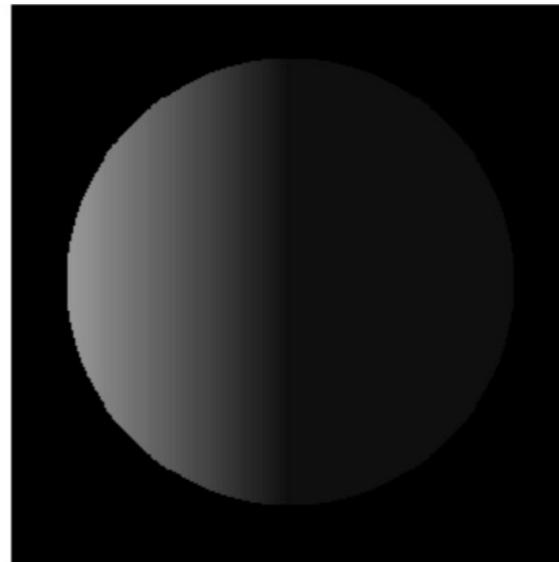

Even though the moon appears matte, its edges remain bright.



Rough diffuse appearance

Surface Roughness Causes Flat Appearance

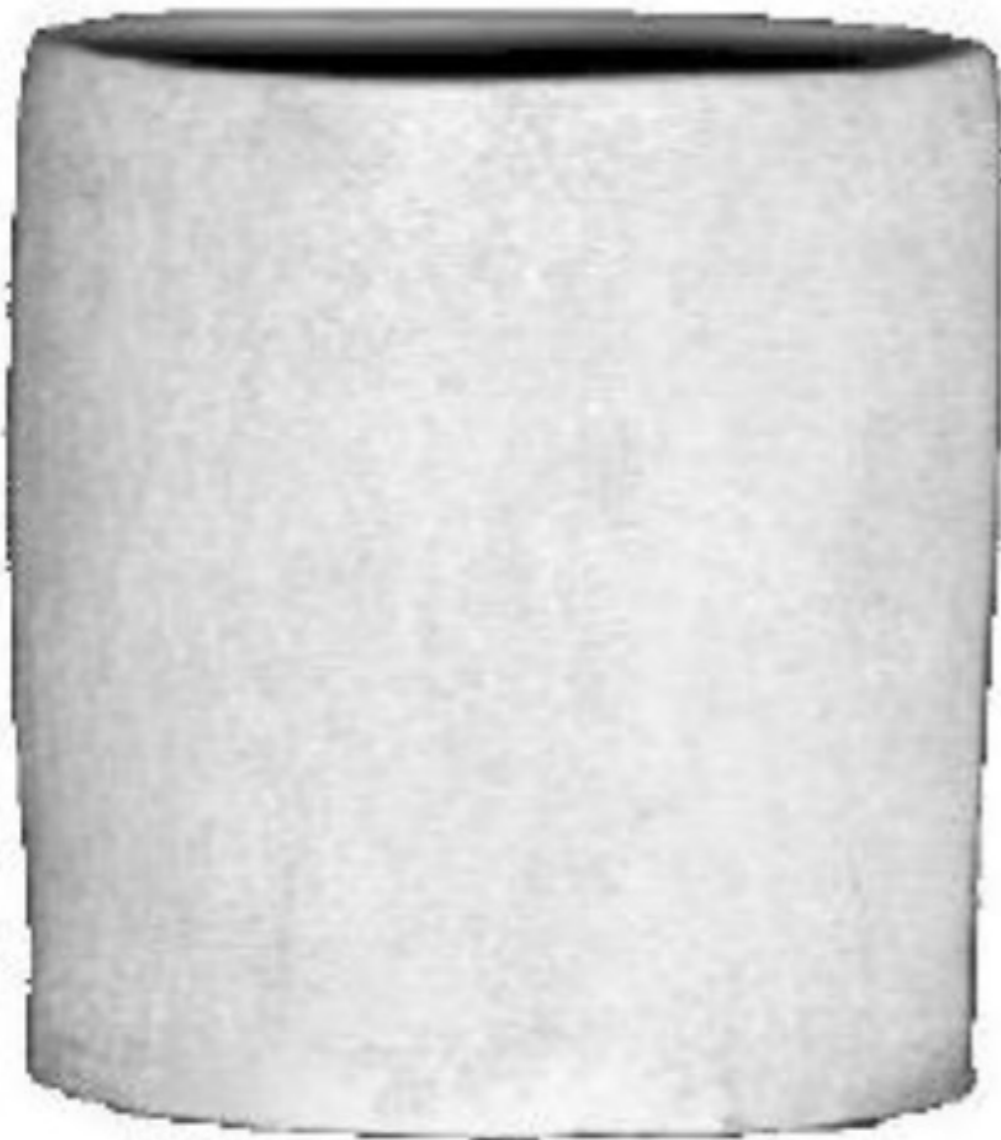

Actual Vase



Lambertian Vase

Photometric stereo

Even simpler: Directional lighting

- Assume that, over the observed region of interest, all source of incoming flux is from one direction

$$L(x, \omega, t, \lambda) \longrightarrow L(\omega, t, \lambda) \longrightarrow s(t, \lambda) \delta(\omega = \omega_o(t))$$

$$L(x, \omega) \longrightarrow L(\omega) \longrightarrow s \delta(\omega = \omega_o)$$

- Convenient representation

$$\vec{\ell} = (l_x, l_y, l_z)$$

“light direction” $\hat{\ell} = \frac{\vec{\ell}}{||\vec{\ell}||}$

“light strength” $||\vec{\ell}||$

Simple shading

ASSUMPTION 1:
LAMBERTIAN

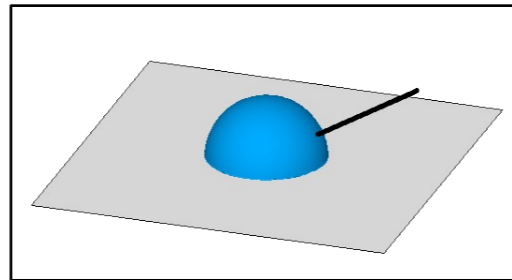

ASSUMPTION 2:
DIRECTIONAL LIGHTING



$$L^{\text{out}}(\hat{\omega}) = \int_{\Omega_{\text{in}}} f(\hat{\omega}_{\text{in}}, \hat{\omega}_{\text{out}}) L^{\text{in}}(\hat{\omega}_{\text{in}}) \cos \theta_{\text{in}} d\hat{\omega}_{\text{in}}$$

$$I = a \hat{\mathbf{n}}^{\top} \vec{\ell}$$

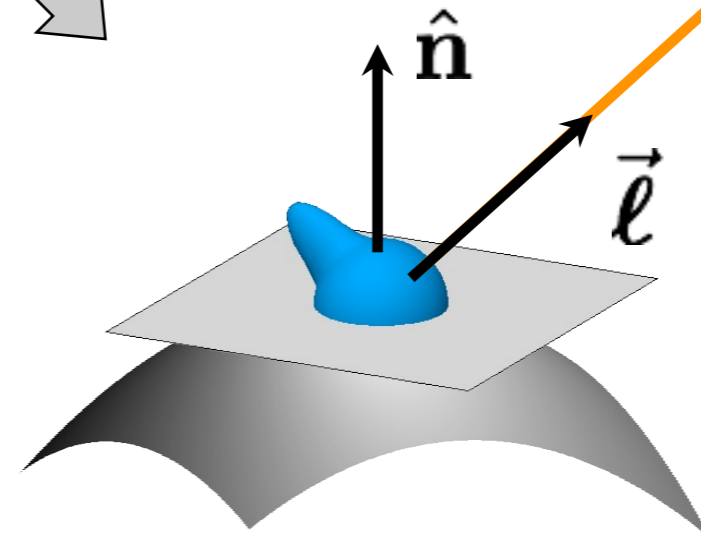
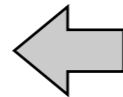

“N-dot-l” shading

ASSUMPTION 1:
LAMBERTIAN

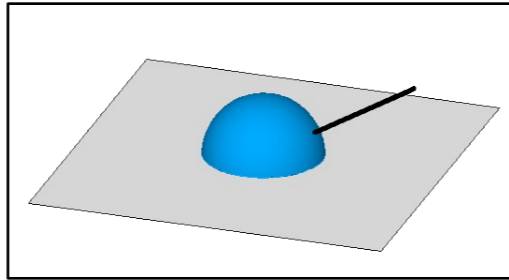

ASSUMPTION 2:
DIRECTIONAL LIGHTING

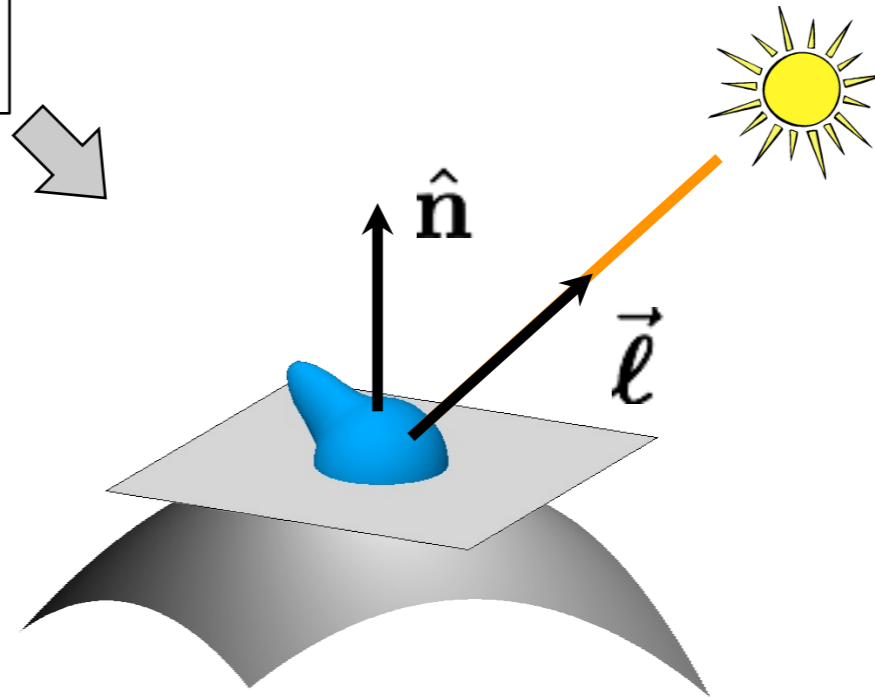

$$L^{\text{out}}(\hat{\omega}) = \int_{\Omega_{\text{in}}} f(\hat{\omega}_{\text{in}}, \hat{\omega}_{\text{out}}) L^{\text{in}}(\hat{\omega}_{\text{in}}) \cos \theta_{\text{in}} d\hat{\omega}_{\text{in}}$$

$$I = a \hat{\mathbf{n}}^{\top} \vec{\ell}$$

Image Intensity and 3D Geometry



- *Shading* as a cue for shape reconstruction
- What is the relation between intensity and shape?

“N-dot-l” shading

ASSUMPTION 1:
LAMBERTIAN

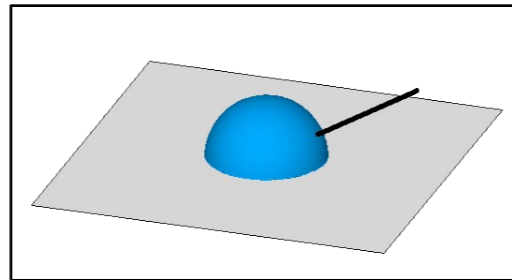

ASSUMPTION 2:
DIRECTIONAL LIGHTING

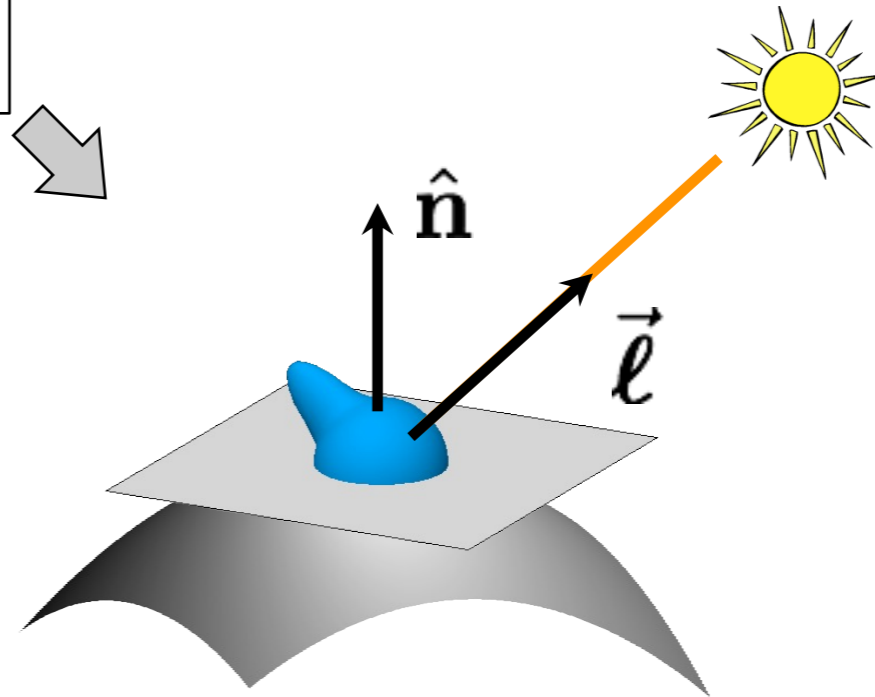

$$L^{\text{out}}(\hat{\omega}) = \int_{\Omega_{\text{in}}} f(\hat{\omega}_{\text{in}}, \hat{\omega}_{\text{out}}) L^{\text{in}}(\hat{\omega}_{\text{in}}) \cos \theta_{\text{in}} d\hat{\omega}_{\text{in}}$$

$$I = a \hat{\mathbf{n}}^{\top} \vec{\ell}$$

Why do we call these normal “shape”?

Surfaces and normals

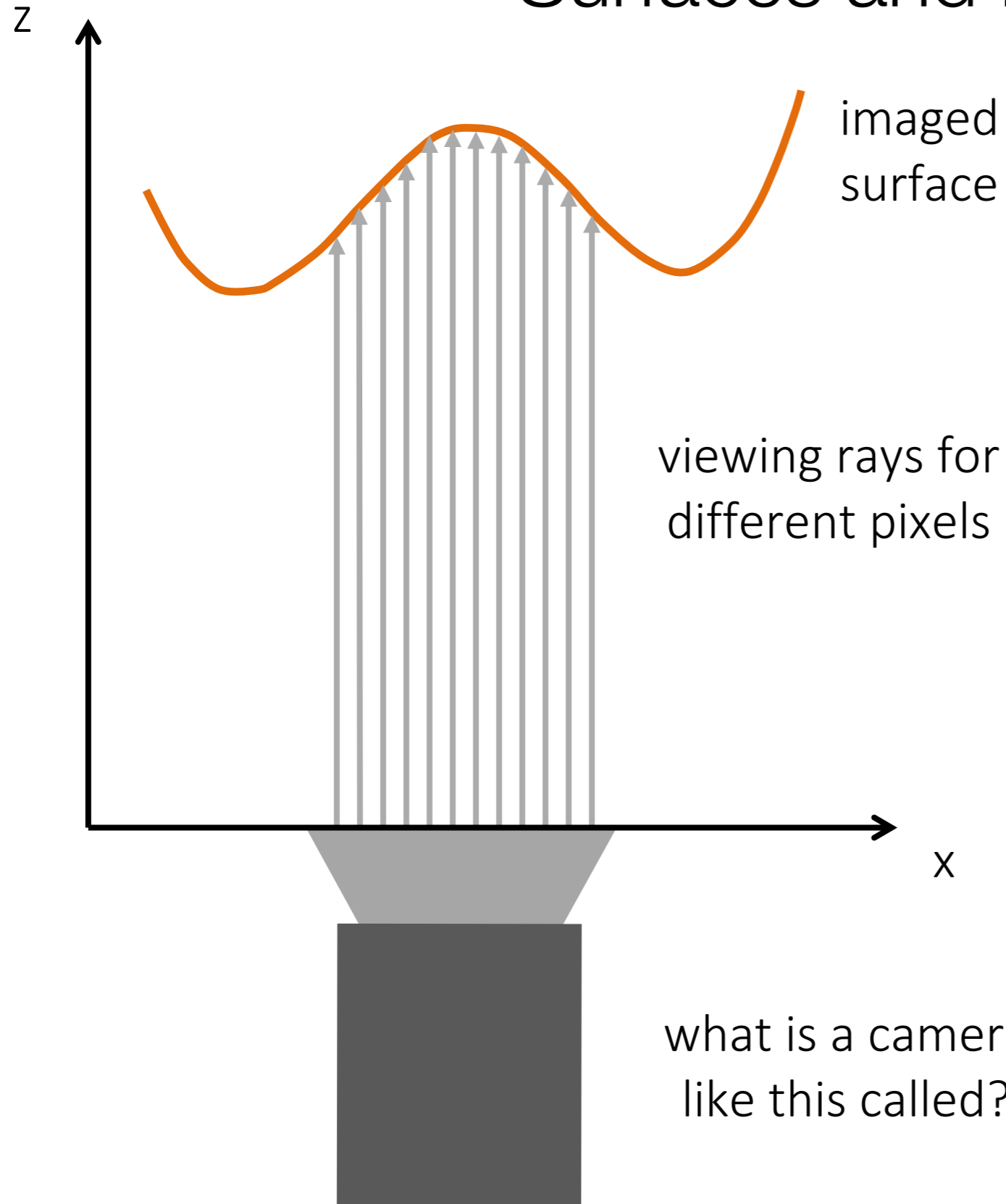

Surfaces and normals

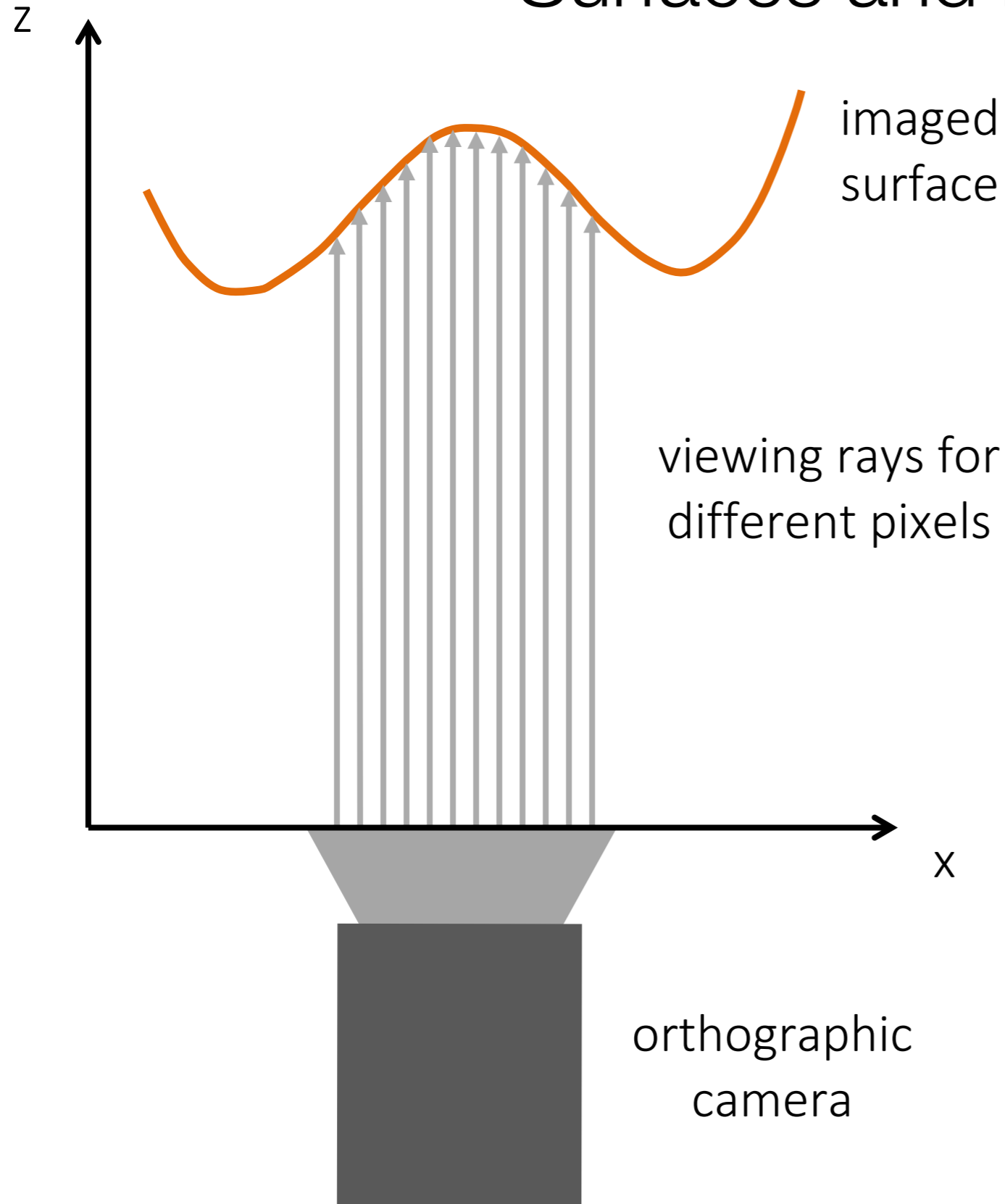

Surface representation as a depth field (also known as Monge surface):

$$z = f(\underbrace{x, y}_{\text{pixel coordinates on image plane}})$$



depth at each pixel

pixel coordinates on image plane

How does surface normal relate to this representation?

Surfaces and normals

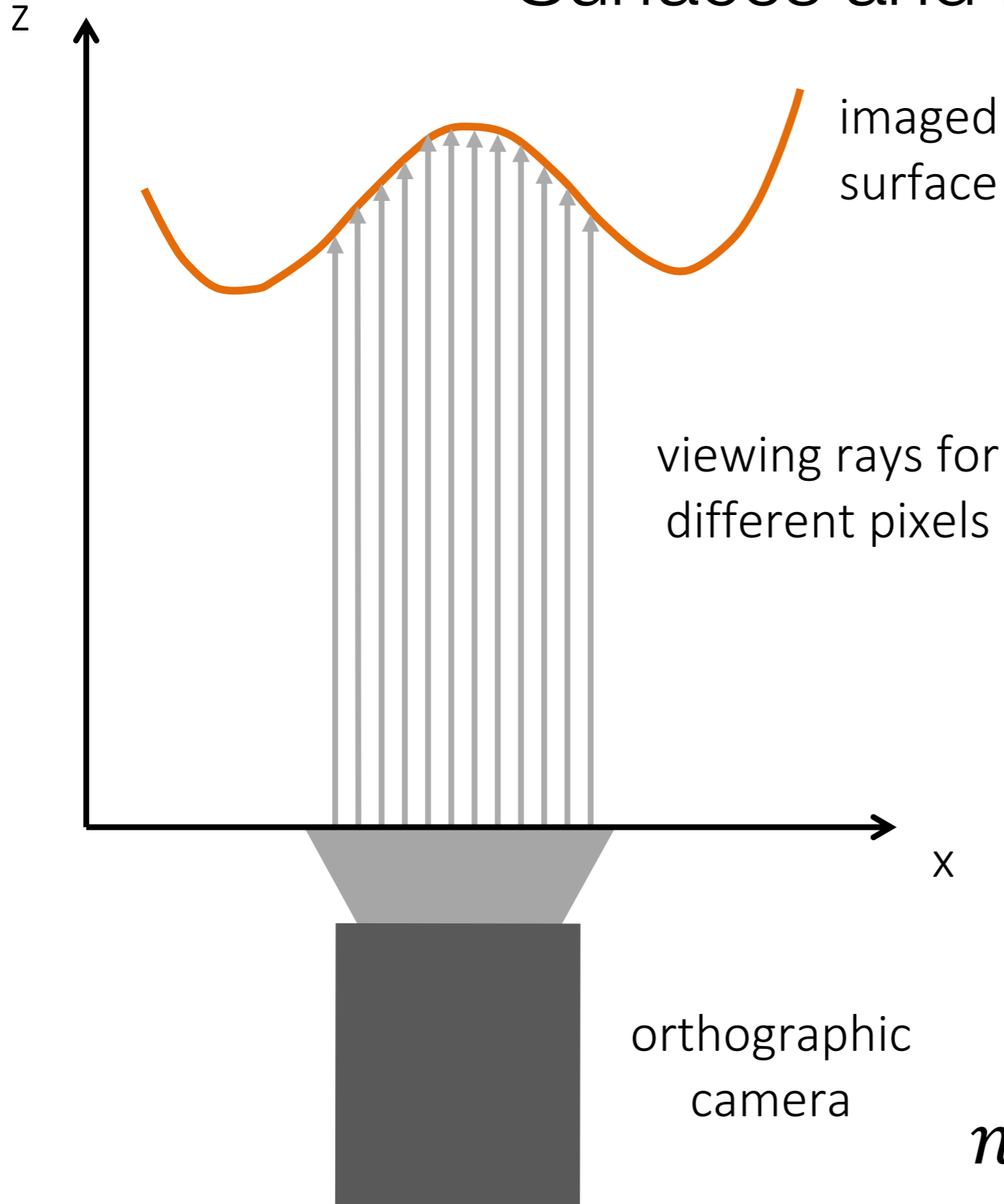

Surface representation as a depth image (also known as Monge surface):

$$z = f(\underbrace{x, y}_{\text{pixel coordinates on image plane}})$$



pixel coordinates on image plane

depth at each pixel

Unnormalized normal:

$$\tilde{n}(x, y) = \left(\frac{df}{dx}, \frac{df}{dy}, -1 \right)$$

Actual normal:

$$n(x, y) = \tilde{n}(x, y) / \|\tilde{n}(x, y)\|$$

Normals are scaled spatial derivatives of depth image!

Shape from a Single Image?

- Given a single image of an object with known surface reflectance taken under a known light source, can we recover the shape of the object?

Human Perception

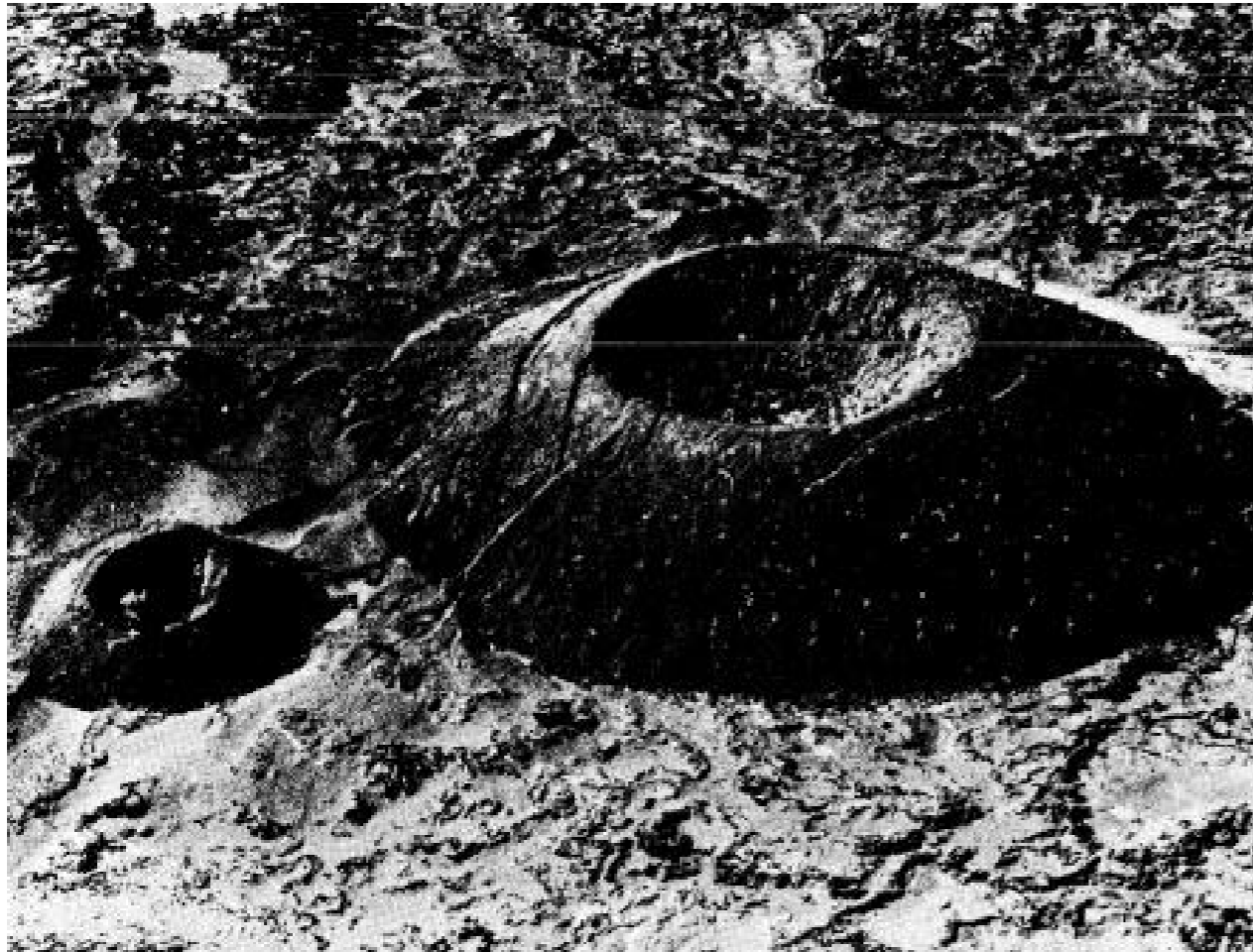

Examples of the classic bump/dent stimuli used to test lighting assumptions when judging shape from shading, with shading orientations (a) 0° and (b) 180° from the vertical.

a

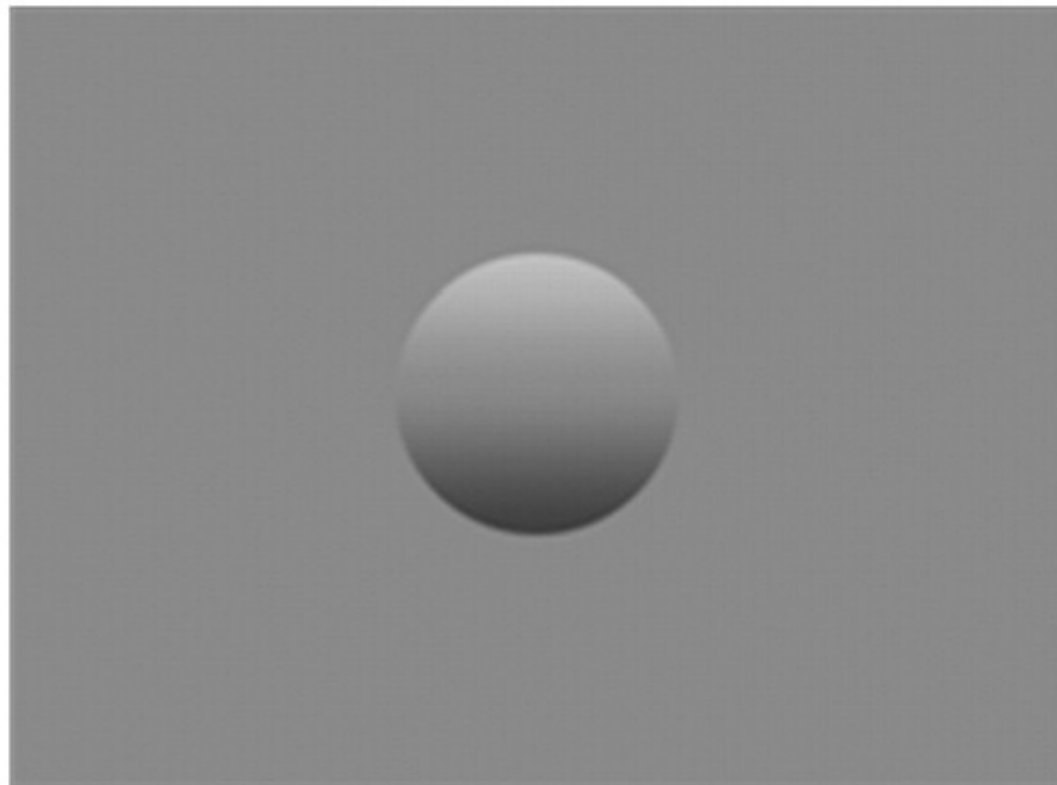

b

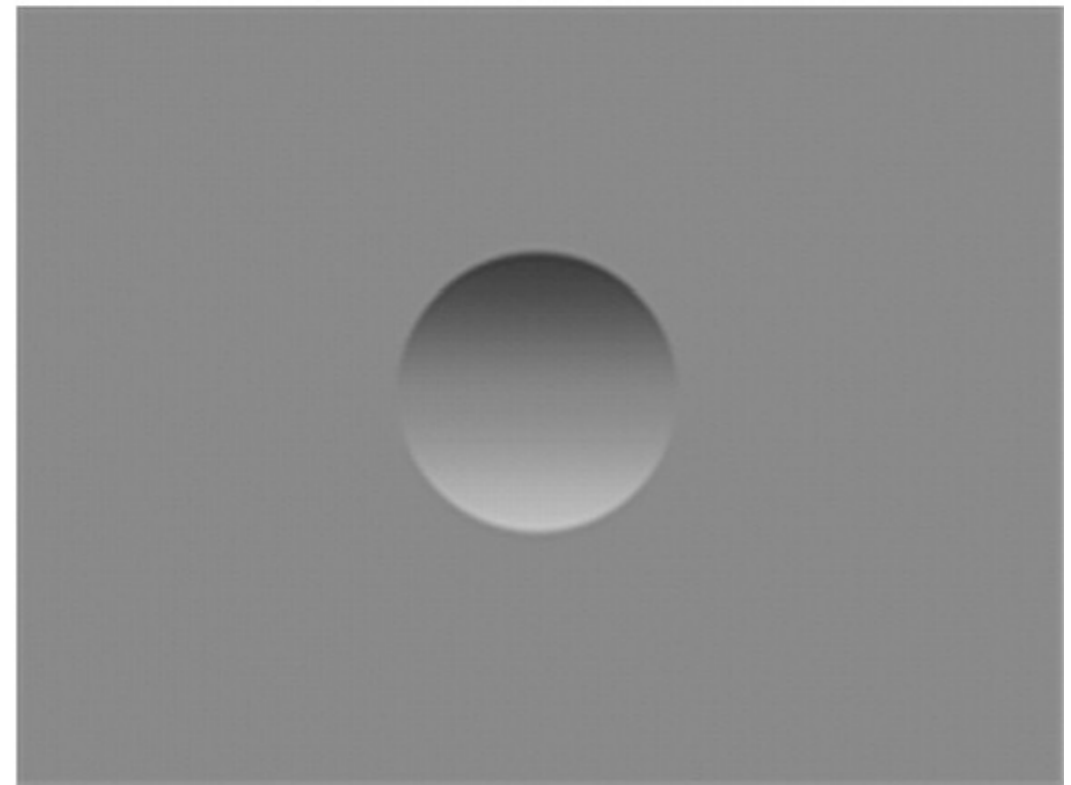

Human Perception

- Our brain often perceives shape from shading.
- Mostly, it makes many assumptions to do so.
- For example:

Light is coming from above (sun).

Biased by occluding contours.

by V. Ramachandran

Single-lighting is ambiguous

ASSUMPTION 1:
LAMBERTIAN

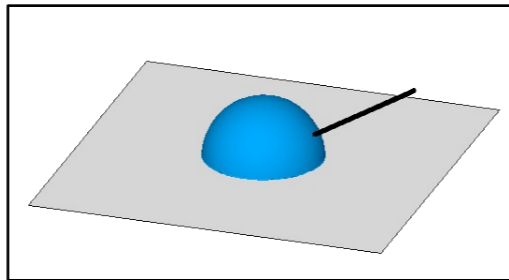

ASSUMPTION 2:
DIRECTIONAL LIGHTING

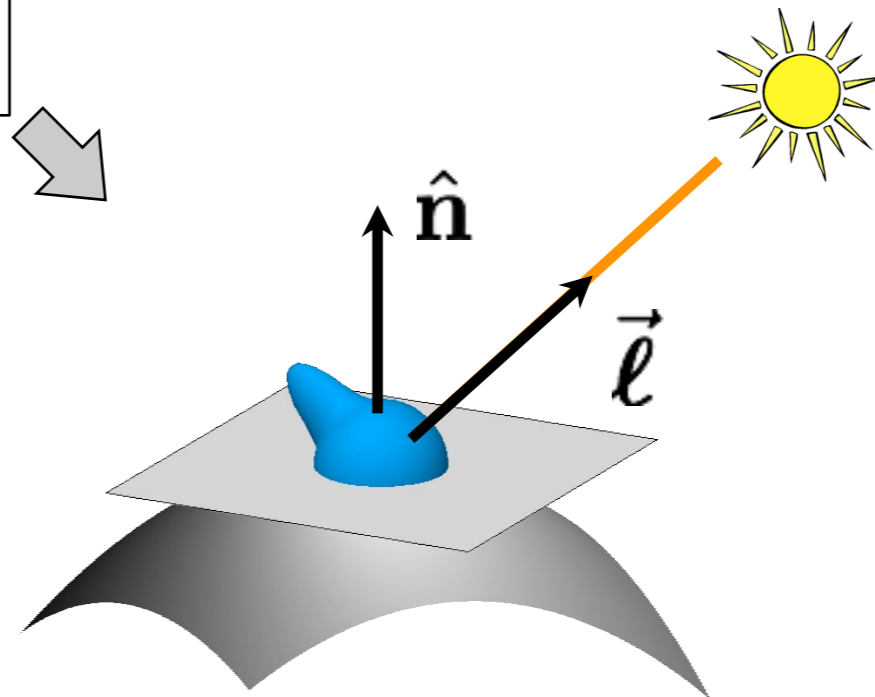

$$L^{\text{out}}(\hat{\omega}) = \int_{\Omega_{\text{in}}} f(\hat{\omega}_{\text{in}}, \hat{\omega}_{\text{out}}) L^{\text{in}}(\hat{\omega}_{\text{in}}) \cos \theta_{\text{in}} d\hat{\omega}_{\text{in}}$$

$$I = a \hat{n}^{\top} \vec{\ell}$$

Lambertian photometric stereo

$$\begin{aligned} I_1 &= a \hat{\mathbf{n}}^\top \vec{\ell}_1 \\ I_2 &= a \hat{\mathbf{n}}^\top \vec{\ell}_2 \\ &\vdots \\ I_N &= a \hat{\mathbf{n}}^\top \vec{\ell}_N \end{aligned}$$

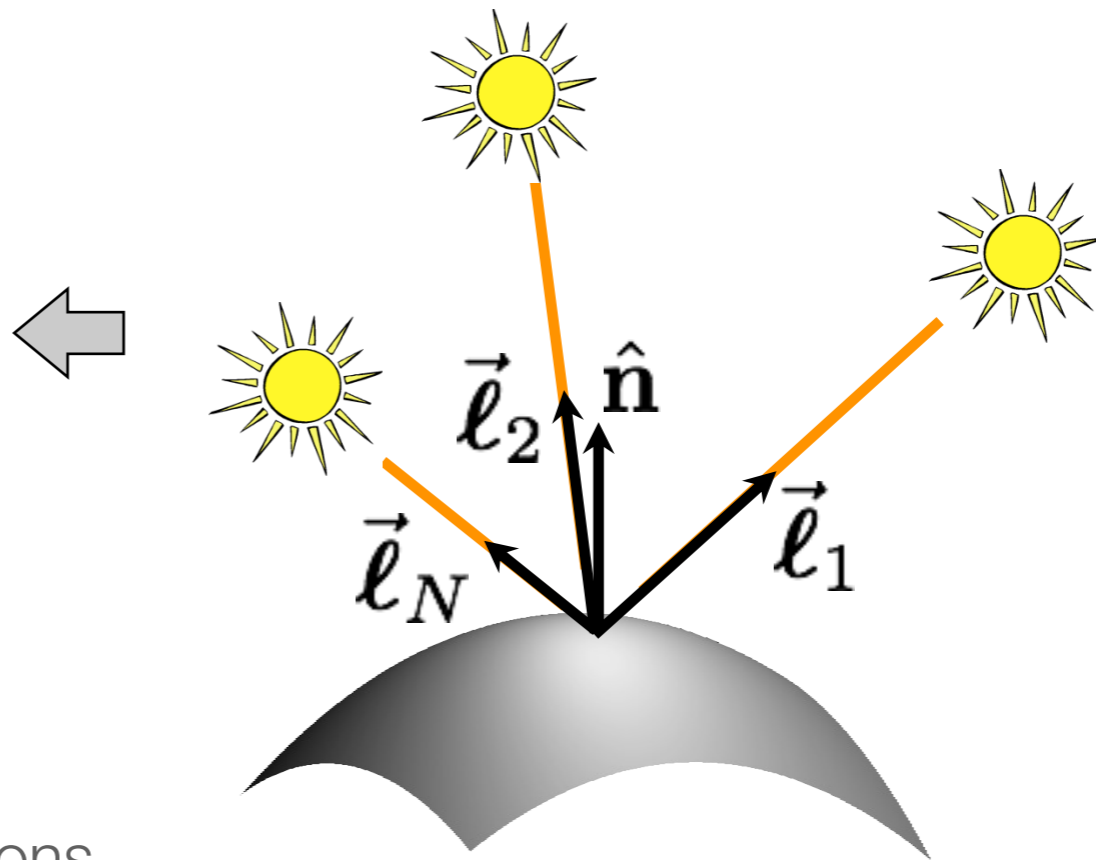

Assumption: We know the lighting directions.

Lambertian photometric stereo

$$\begin{aligned} I_1 &= a \hat{n}^\top \vec{l}_1 \\ I_2 &= a \hat{n}^\top \vec{l}_2 \\ &\vdots \\ I_N &= a \hat{n}^\top \vec{l}_N \end{aligned}$$

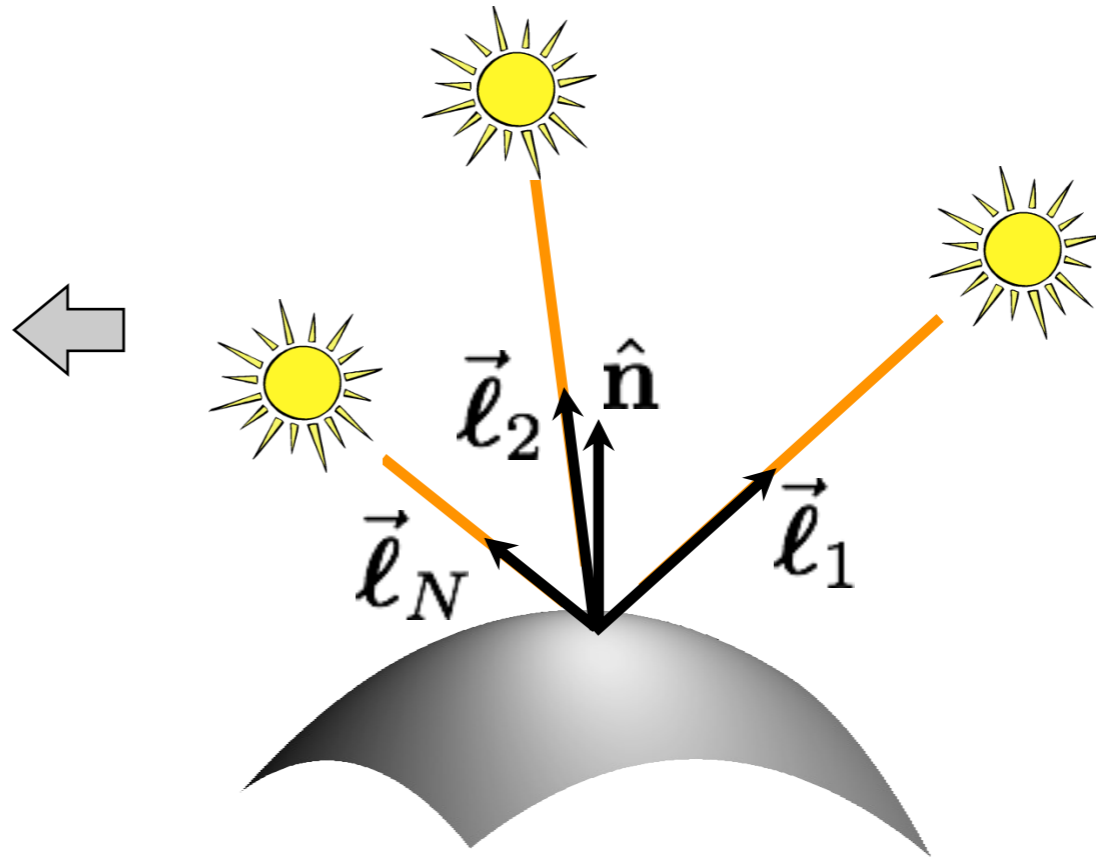

define “pseudo-normal” $\vec{b} \triangleq a \hat{n}$

solve linear system
for pseudo-normal

$$\begin{bmatrix} I_1 \\ I_2 \\ \vdots \\ I_N \end{bmatrix} = \begin{bmatrix} \vec{l}_1^\top \\ \vec{l}_2^\top \\ \vdots \\ \vec{l}_N^\top \end{bmatrix} \begin{bmatrix} \vec{b} \end{bmatrix}$$

What are the
dimensions of
these matrices?

Lambertian photometric stereo

$$\begin{aligned}
 I_1 &= a \hat{\mathbf{n}}^\top \vec{\ell}_1 \\
 I_2 &= a \hat{\mathbf{n}}^\top \vec{\ell}_2 \\
 &\vdots \\
 I_N &= a \hat{\mathbf{n}}^\top \vec{\ell}_N
 \end{aligned}$$

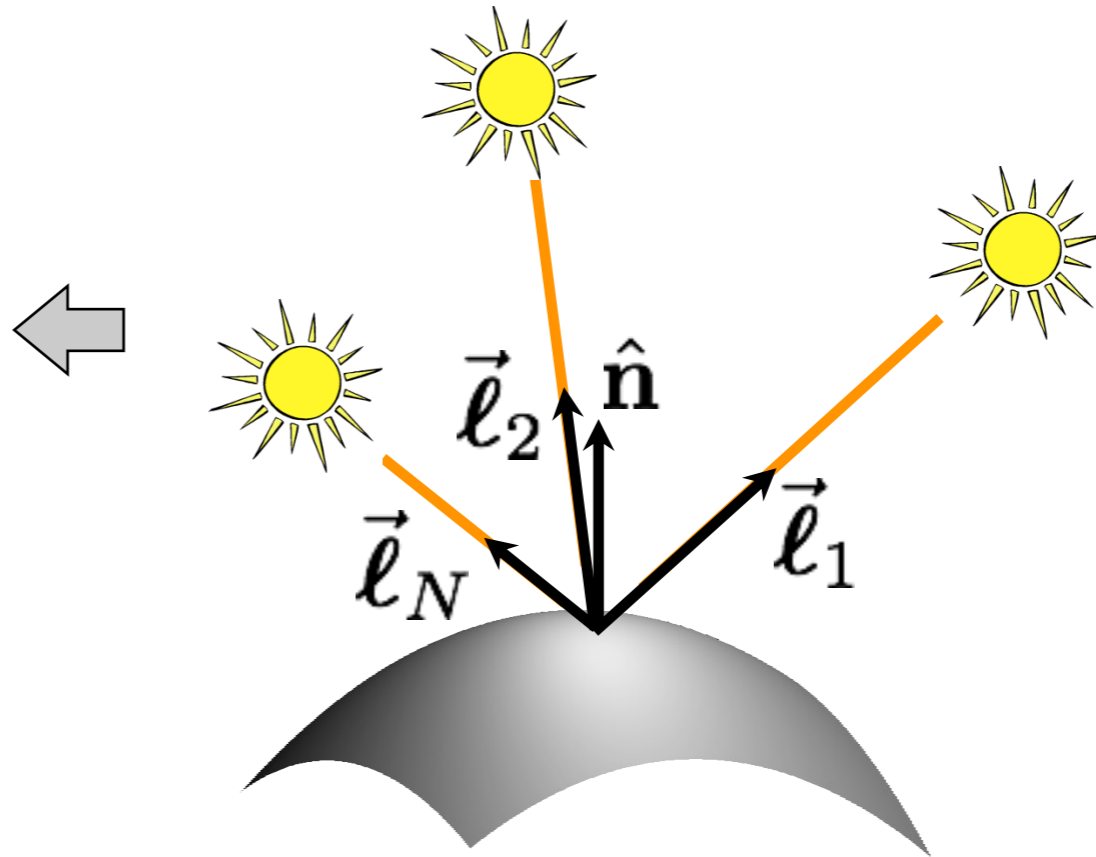

define “pseudo-normal” $\vec{\mathbf{b}} \triangleq a \hat{\mathbf{n}}$

solve linear system
for pseudo-normal

What are the
knowns and
unknowns?

$$\begin{bmatrix} I_1 \\ I_2 \\ \vdots \\ I_N \end{bmatrix}_{N \times 1} = \begin{bmatrix} \vec{\ell}_1^\top \\ \vec{\ell}_2^\top \\ \vdots \\ \vec{\ell}_N^\top \end{bmatrix}_{N \times 3} \begin{bmatrix} \vec{\mathbf{b}} \end{bmatrix}_{3 \times 1}$$

Lambertian photometric stereo

$$\begin{aligned}
 I_1 &= a \hat{n}^\top \vec{l}_1 \\
 I_2 &= a \hat{n}^\top \vec{l}_2 \\
 &\vdots \\
 I_N &= a \hat{n}^\top \vec{l}_N
 \end{aligned}$$

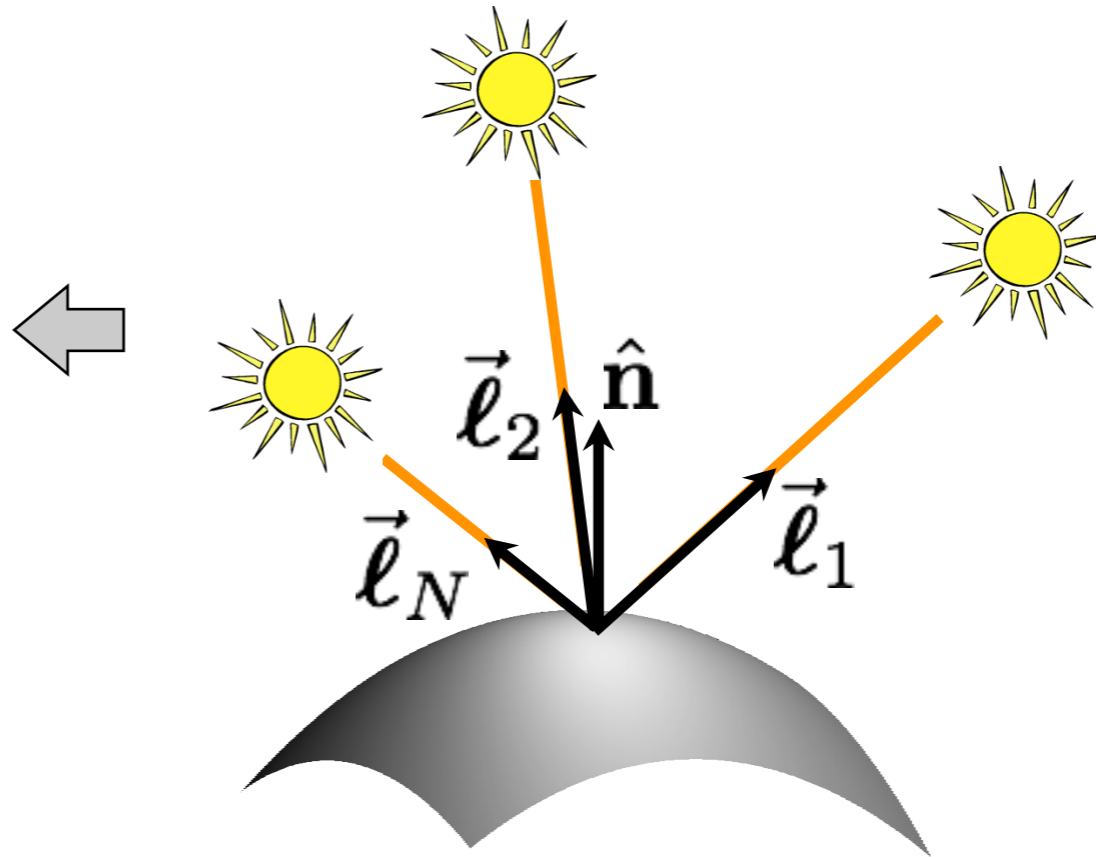

define “pseudo-normal” $\vec{b} \triangleq a \hat{n}$

solve linear system
for pseudo-normal

How many lights
do I need for
unique solution?

$$\begin{bmatrix} I_1 \\ I_2 \\ \vdots \\ I_N \end{bmatrix}_{N \times 1} = \begin{bmatrix} \vec{l}_1^\top \\ \vec{l}_2^\top \\ \vdots \\ \vec{l}_N^\top \end{bmatrix}_{N \times 3} \begin{bmatrix} \vec{b} \end{bmatrix}_{3 \times 1}$$

Lambertian photometric stereo

$$\begin{aligned}
 I_1 &= a \hat{\mathbf{n}}^\top \vec{\ell}_1 \\
 I_2 &= a \hat{\mathbf{n}}^\top \vec{\ell}_2 \\
 &\vdots \\
 I_N &= a \hat{\mathbf{n}}^\top \vec{\ell}_N
 \end{aligned}$$

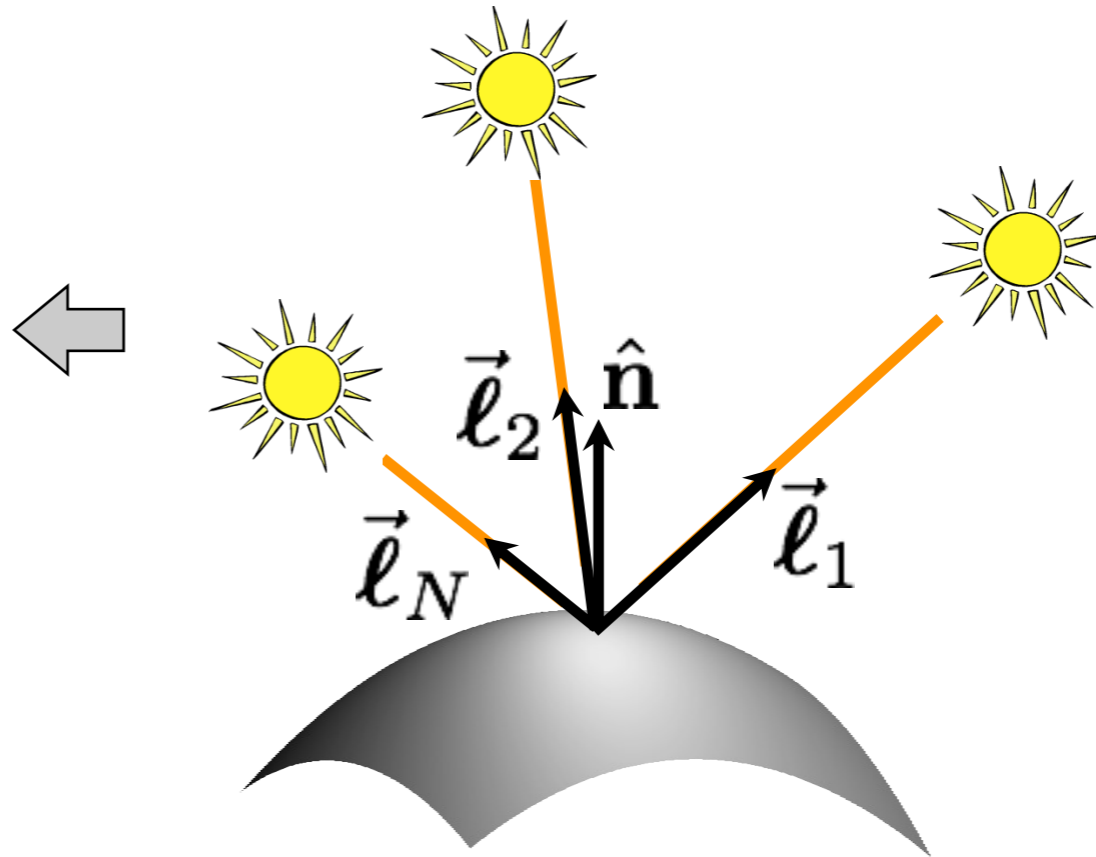

define “pseudo-normal” $\vec{\mathbf{b}} \triangleq a \hat{\mathbf{n}}$

solve linear system
for pseudo-normal

$$\begin{bmatrix} I_1 \\ I_2 \\ \vdots \\ I_N \end{bmatrix}_{N \times 1} = \begin{bmatrix} \vec{\ell}_1^\top \\ \vec{\ell}_2^\top \\ \vdots \\ \vec{\ell}_N^\top \end{bmatrix}_{N \times 3} \begin{bmatrix} \vec{\mathbf{b}} \end{bmatrix}_{3 \times 1}$$

once system is solved,
 \mathbf{b} gives normal
direction and albedo

How do we solve
this system?

Solving the Equation with three lights

$$\underbrace{\begin{bmatrix} I_1 \\ I_2 \\ I_2 \end{bmatrix}}_{\substack{\mathbf{I} \\ 3 \times 1}} = \underbrace{\begin{bmatrix} \mathbf{s}_1^T \\ \mathbf{s}_2^T \\ \mathbf{s}_3^T \end{bmatrix}}_{\substack{\mathbf{S} \\ 3 \times 3}} \underbrace{\rho \mathbf{n}}_{\substack{\tilde{\mathbf{n}} \\ 3 \times 1}}$$

$$\tilde{\mathbf{n}} = \mathbf{S}^{-1} \mathbf{I} \quad \text{inverse}$$

$$\rho = |\tilde{\mathbf{n}}|$$

$$\mathbf{n} = \frac{\tilde{\mathbf{n}}}{|\tilde{\mathbf{n}}|} = \frac{\tilde{\mathbf{n}}}{\rho}$$

Is there any reason to use more than three lights?

More than Three Light Sources

- Get better SNR by using more lights

$$\begin{bmatrix} I_1 \\ \vdots \\ I_N \end{bmatrix} = \begin{bmatrix} \mathbf{s}_1^T \\ \vdots \\ \mathbf{s}_N^T \end{bmatrix} \rho \mathbf{n}$$

- Least squares solution:

$$\mathbf{I} = \mathbf{S} \tilde{\mathbf{n}} \quad \longleftarrow \quad N \times 1 = \underbrace{(N \times 3)}_{\text{matrix}} (3 \times 1)$$

$$\mathbf{S}^T \mathbf{I} = \mathbf{S}^T \mathbf{S} \tilde{\mathbf{n}}$$

$$\tilde{\mathbf{n}} = \left(\mathbf{S}^T \mathbf{S} \right)^{-1} \mathbf{S}^T \mathbf{I}$$

Moore-Penrose pseudo inverse

- Solve for ρ, \mathbf{n} as before

Computing light source directions

- Trick: place a chrome sphere in the scene

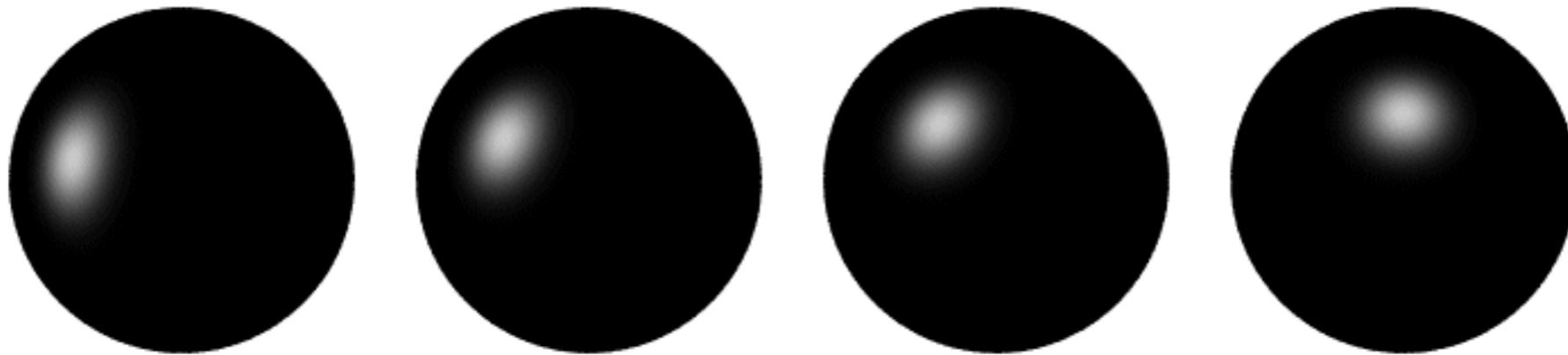

- the location of the highlight tells you the source direction

Limitations

- Big problems
 - Doesn't work for shiny things, semi-translucent things
 - Shadows, inter-reflections
- Smaller problems
 - Camera and lights have to be distant
 - Calibration requirements
 - measure light source directions, intensities
 - camera response function

Depth from normals

- Solving the linear system per-pixel gives us an estimated surface normal for each pixel



Input photo



Estimated normals



Estimated normals
(needle diagram)

- How can we compute depth from normals?
 - Normals are like the “derivative” of the true depth

Surfaces and normals

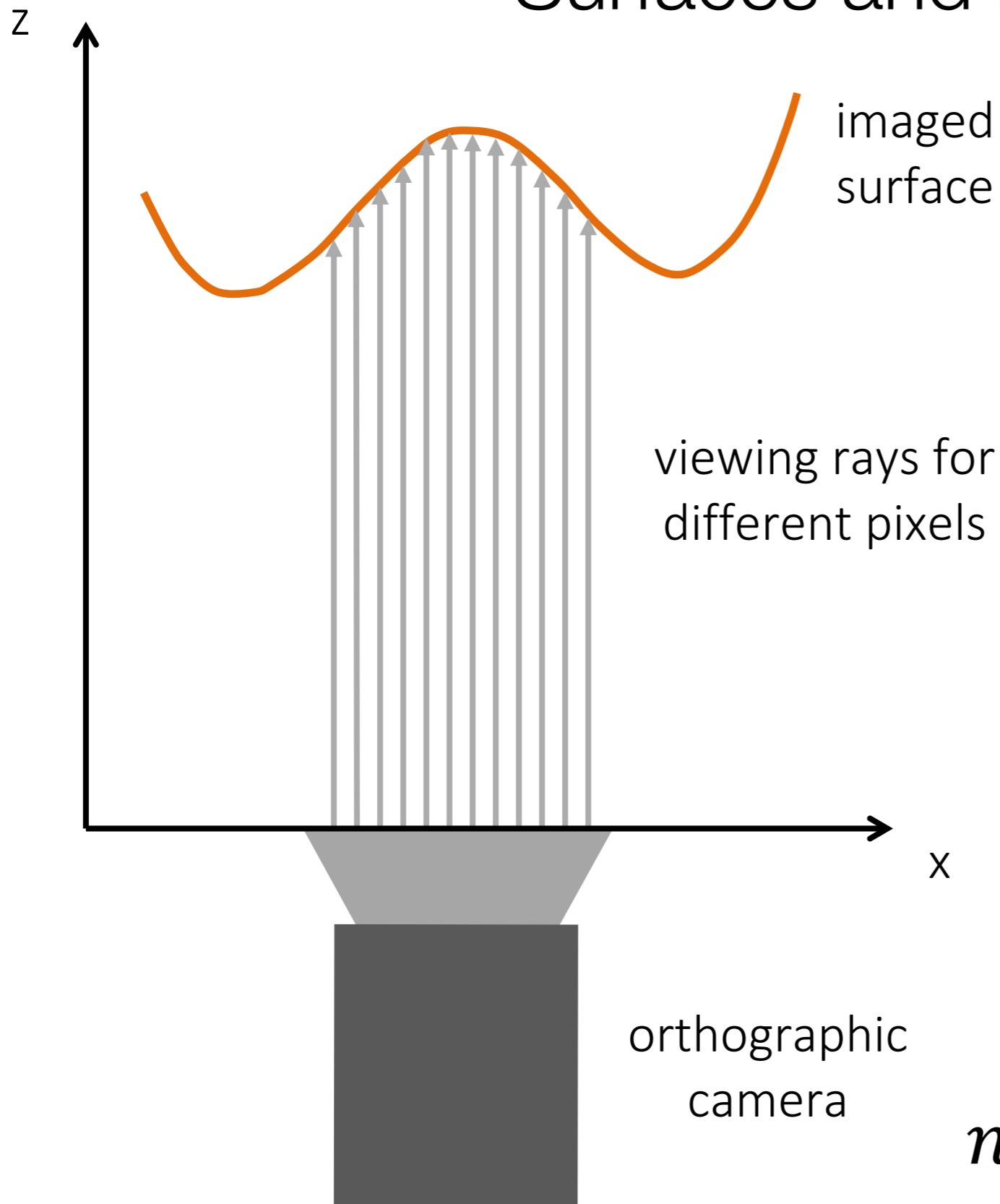

Surface representation as a depth image (also known as Monge surface):

$$z = f(\underbrace{x, y}_{\text{pixel coordinates in image space}})$$



depth at each pixel

Unnormalized normal:

$$\tilde{n}(x, y) = \left(\frac{df}{dx}, \frac{df}{dy}, -1 \right)$$

Actual normal:

$$n(x, y) = \tilde{n}(x, y) / \|\tilde{n}(x, y)\|$$

Normals are scaled spatial derivatives of depth image!

Normal Integration

- Integrating a set of derivatives is easy in 1D
 - (similar to Euler's method from diff. eq. class)

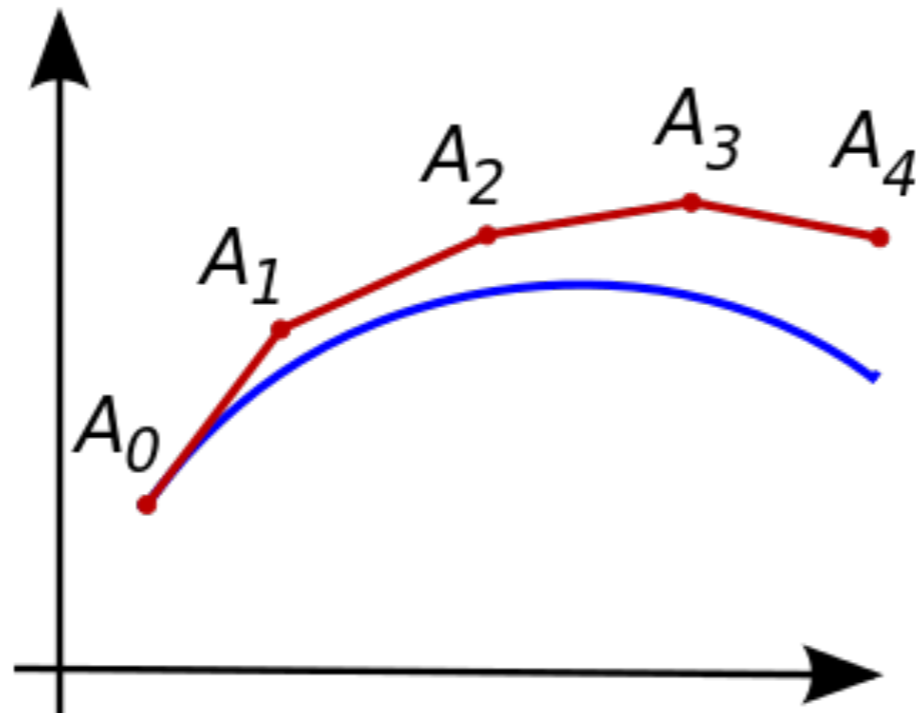

- Could just integrate normals in each column / row separately
- Instead, we formulate as a linear system and solve for depths that *best agree with the surface normals*

Depth from normals

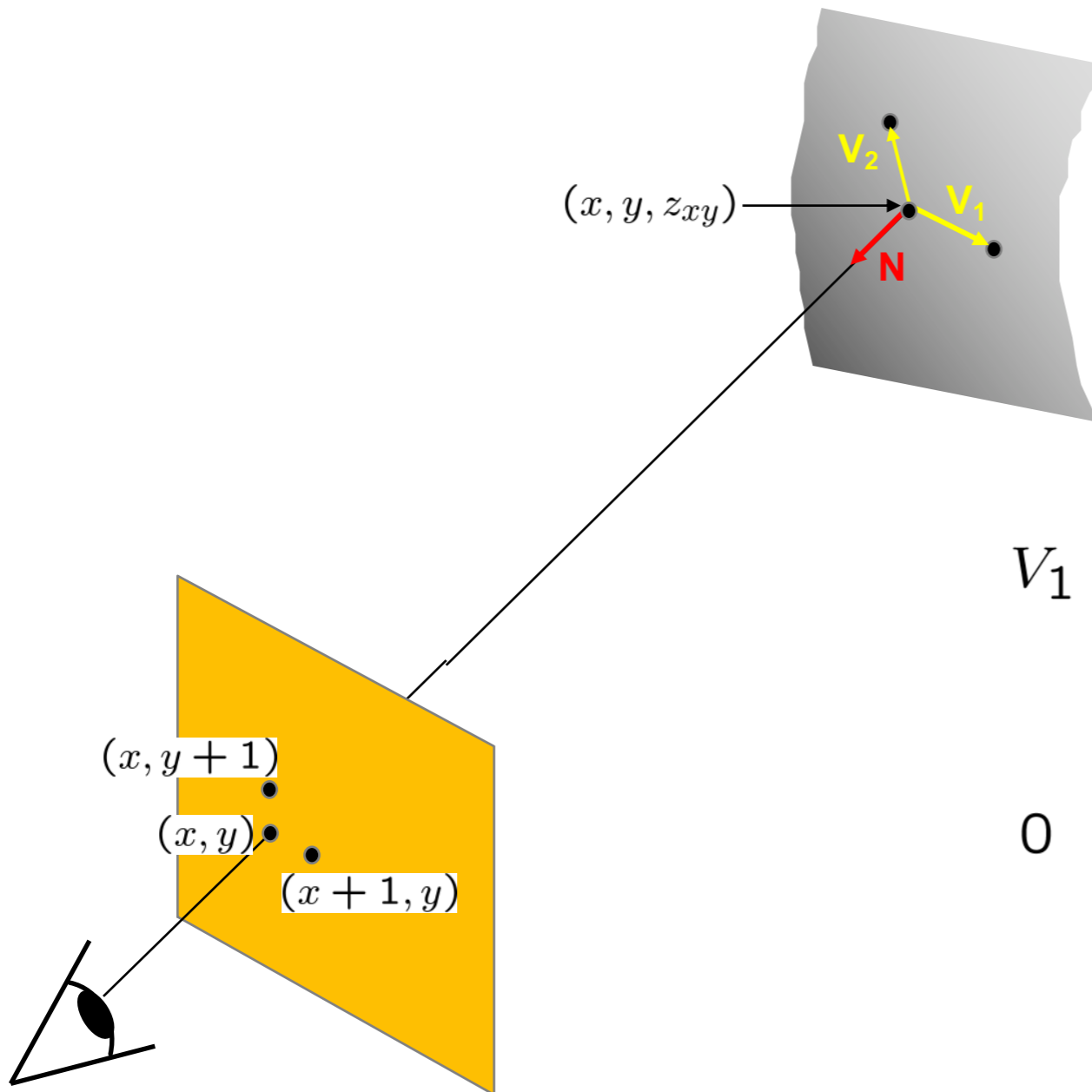

$$\begin{aligned}V_1 &= (x + 1, y, z_{x+1,y}) - (x, y, z_{xy}) \\ &= (1, 0, z_{x+1,y} - z_{xy})\end{aligned}$$

$$\begin{aligned}0 &= N \cdot V_1 \\ &= (n_x, n_y, n_z) \cdot (1, 0, z_{x+1,y} - z_{xy}) \\ &= n_x + n_z(z_{x+1,y} - z_{xy})\end{aligned}$$

Get a similar equation for \mathbf{V}_2

- Each normal gives us two linear constraints on z
- compute z values by solving a matrix equation

Results



1. Estimate light source directions
2. Compute surface normals
3. Compute albedo values
4. Estimate depth from surface normals
5. Relight the object (with original texture and uniform albedo)

Results: Lambertian Sphere

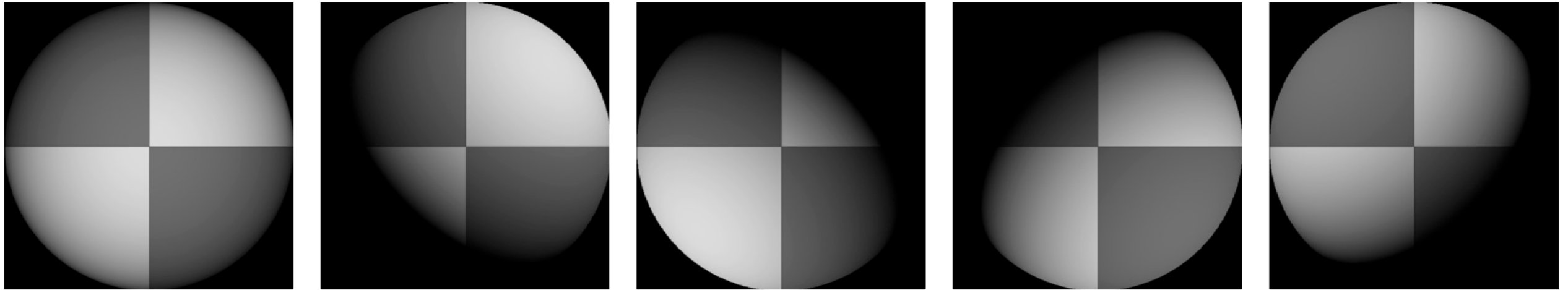

Input Images

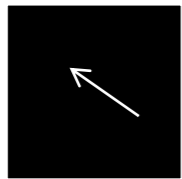

Needles are projections
of surface normals on
image plane

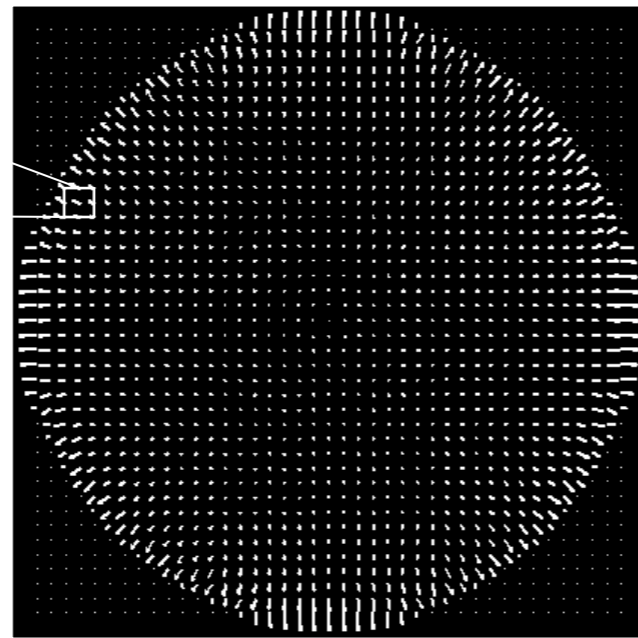

Estimated Surface Normals

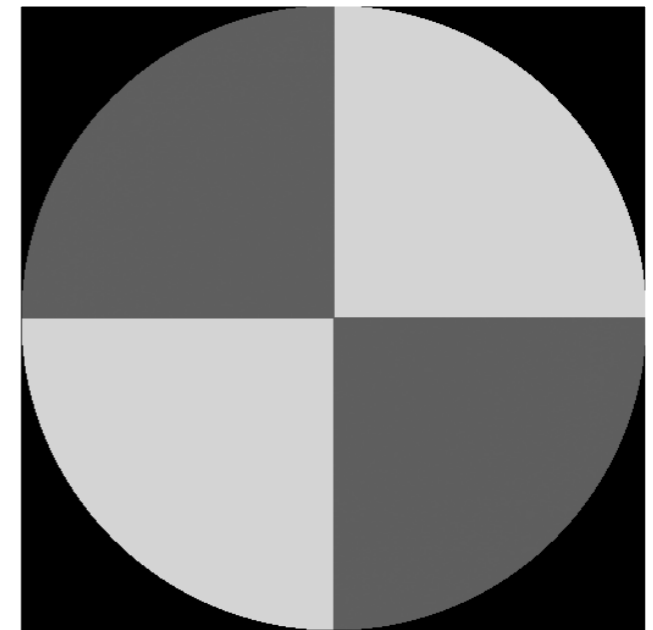

Estimated Albedo

Lambertain Mask

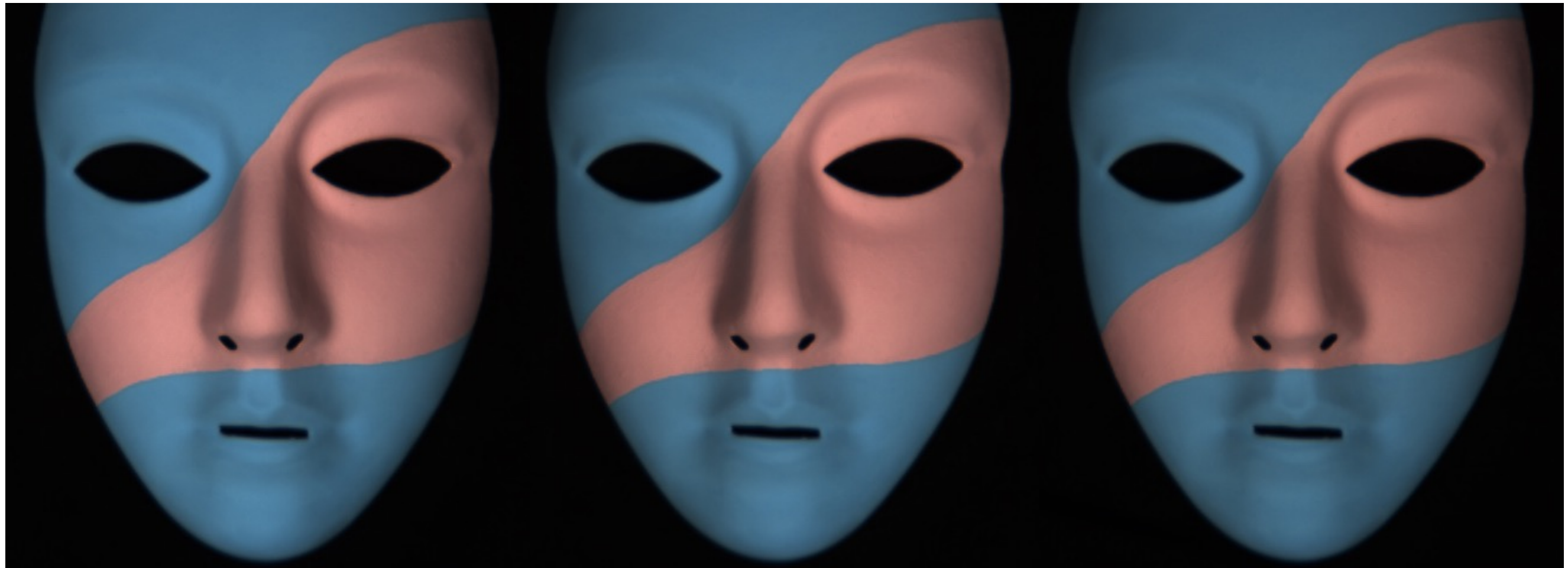

Results – Albedo and Surface Normal

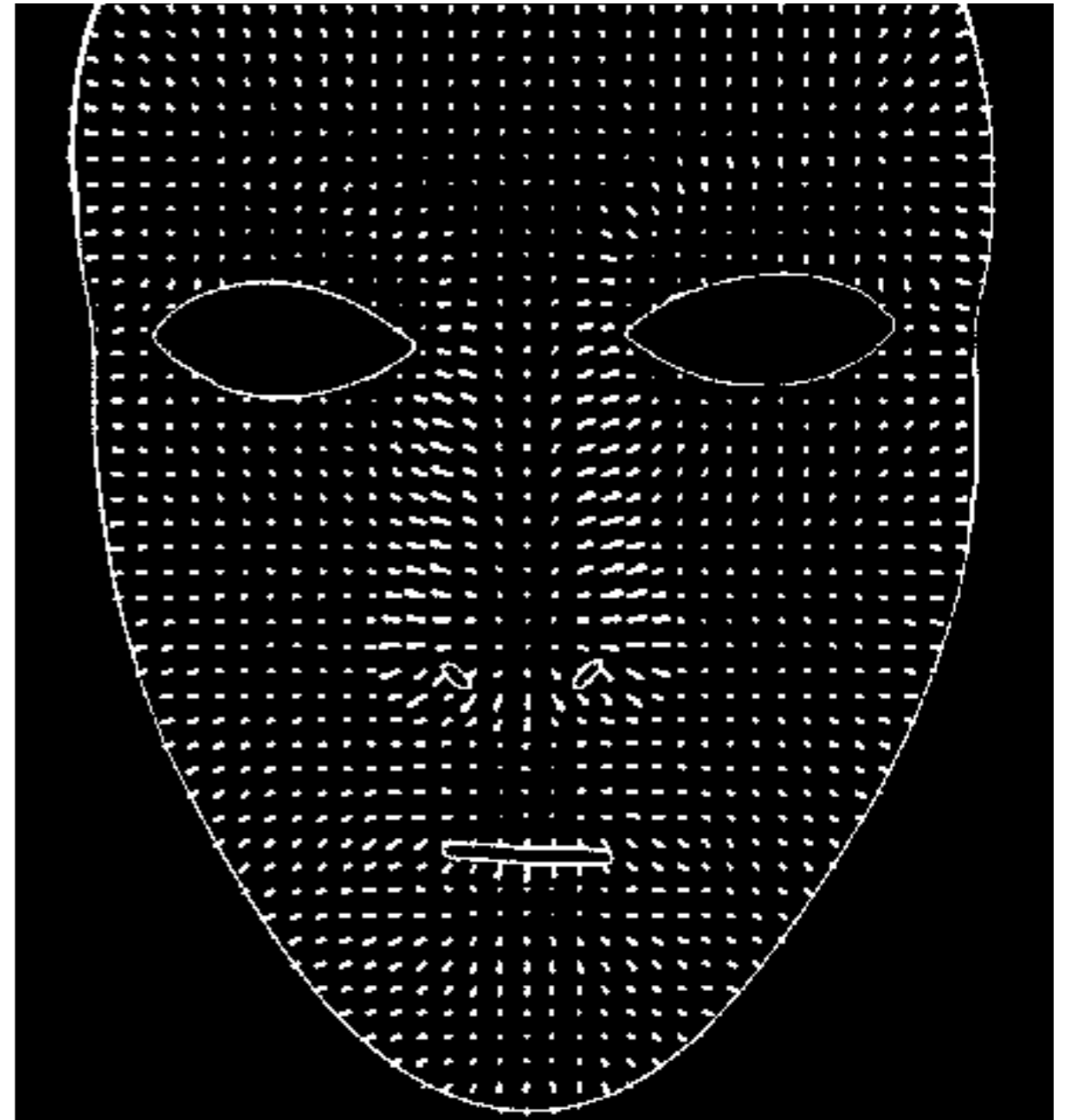
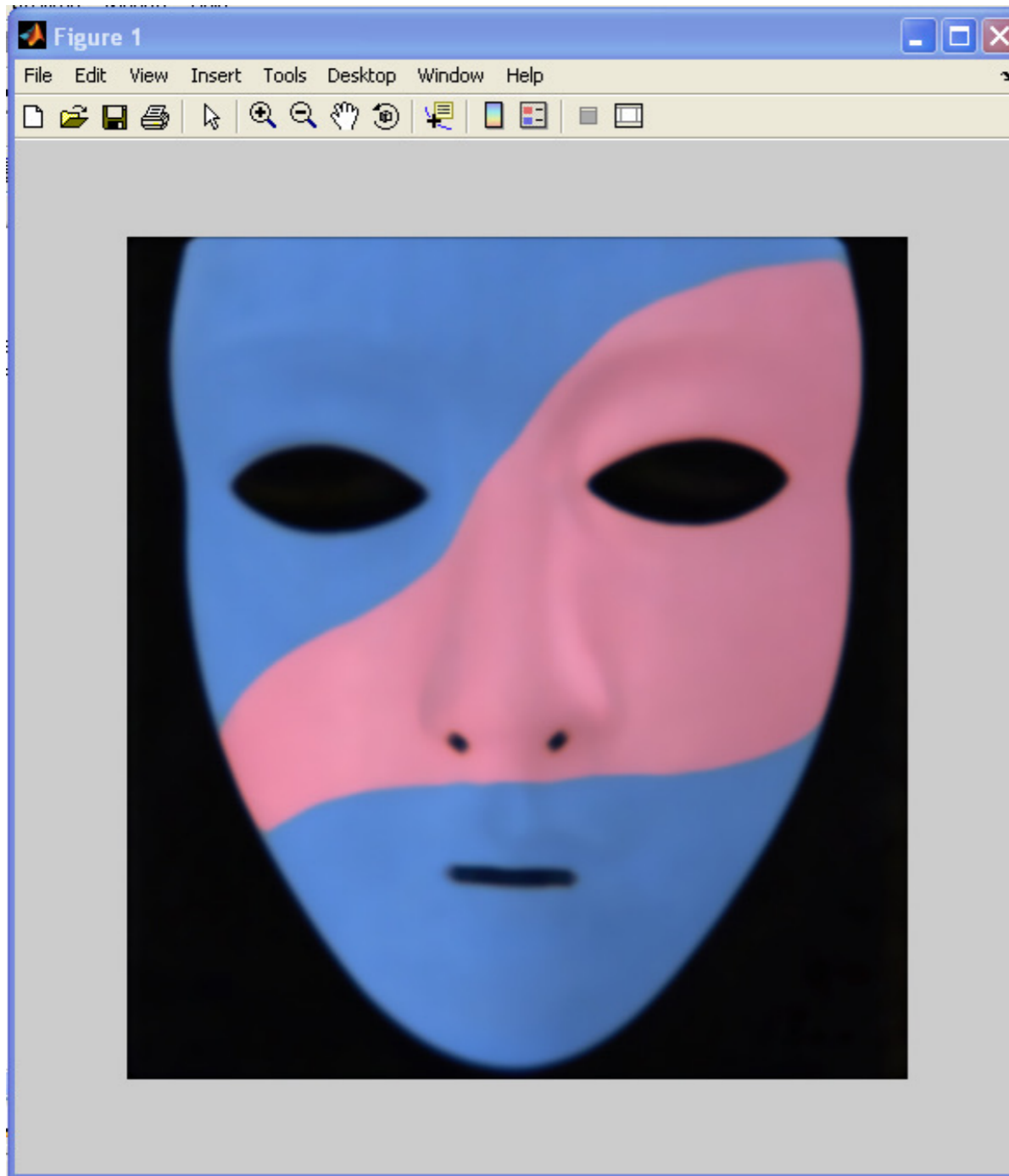

Results – Shape of Mask

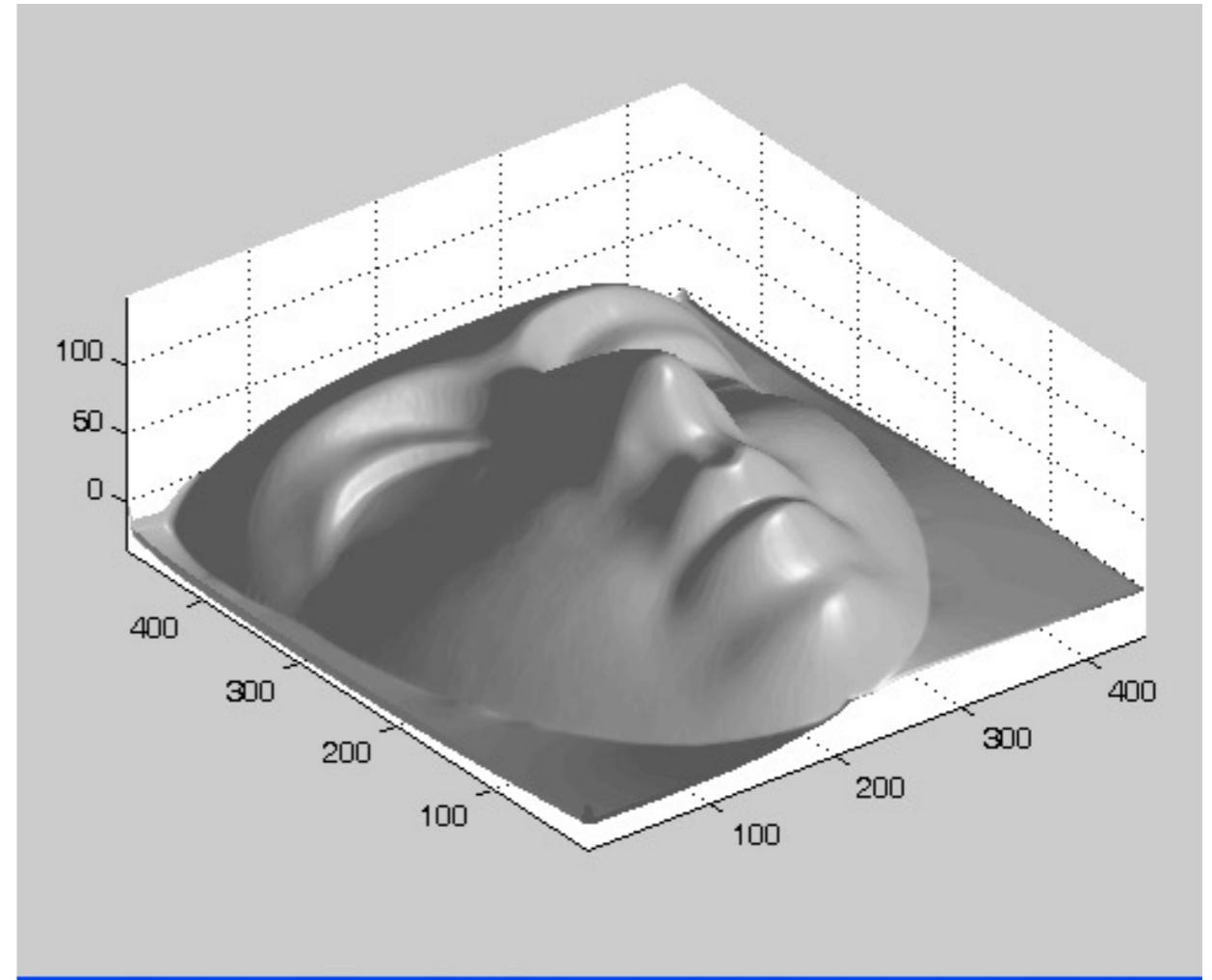
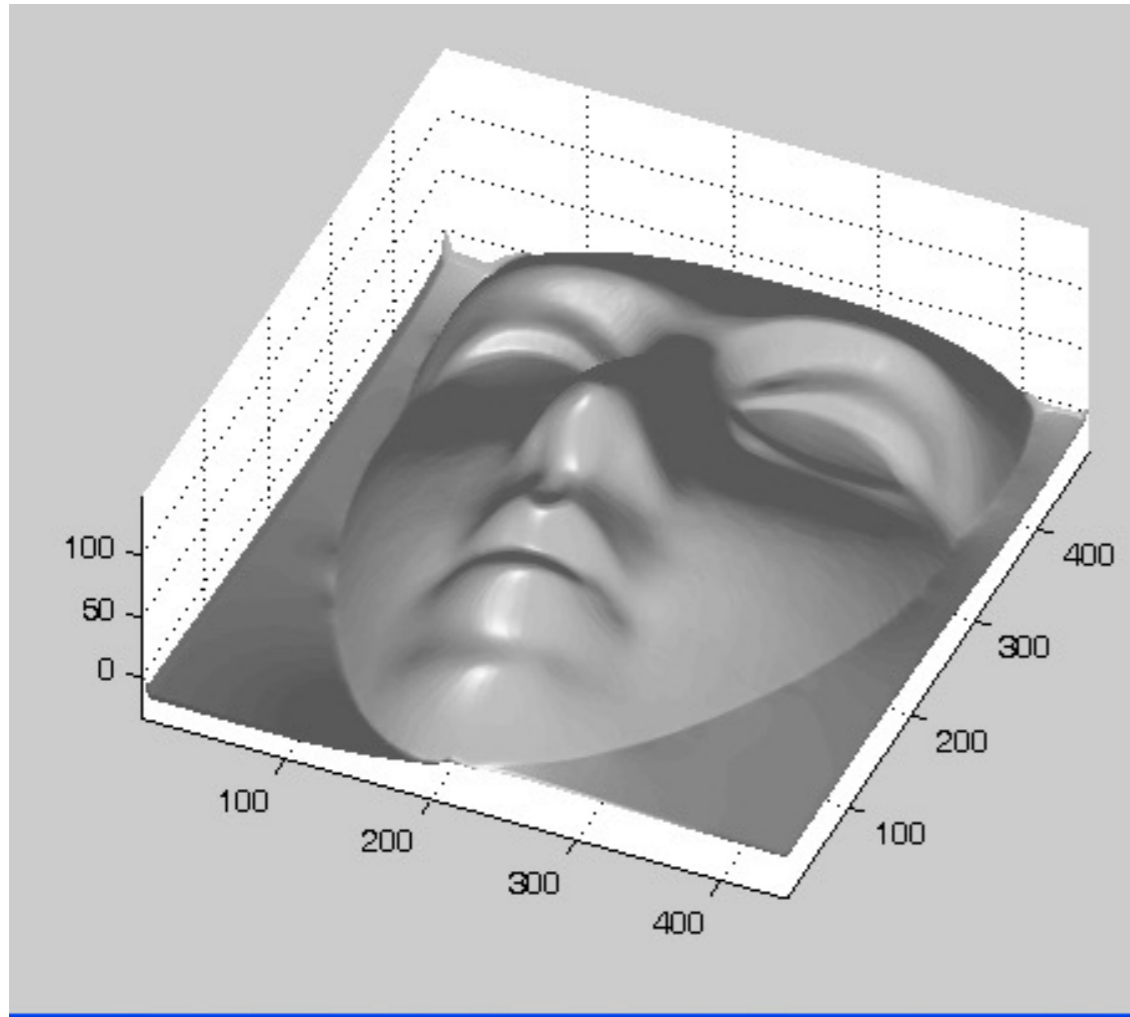

Results: Lambertian Toy



1.2



Non-idealities: interreflections



Non-idealities: interreflections

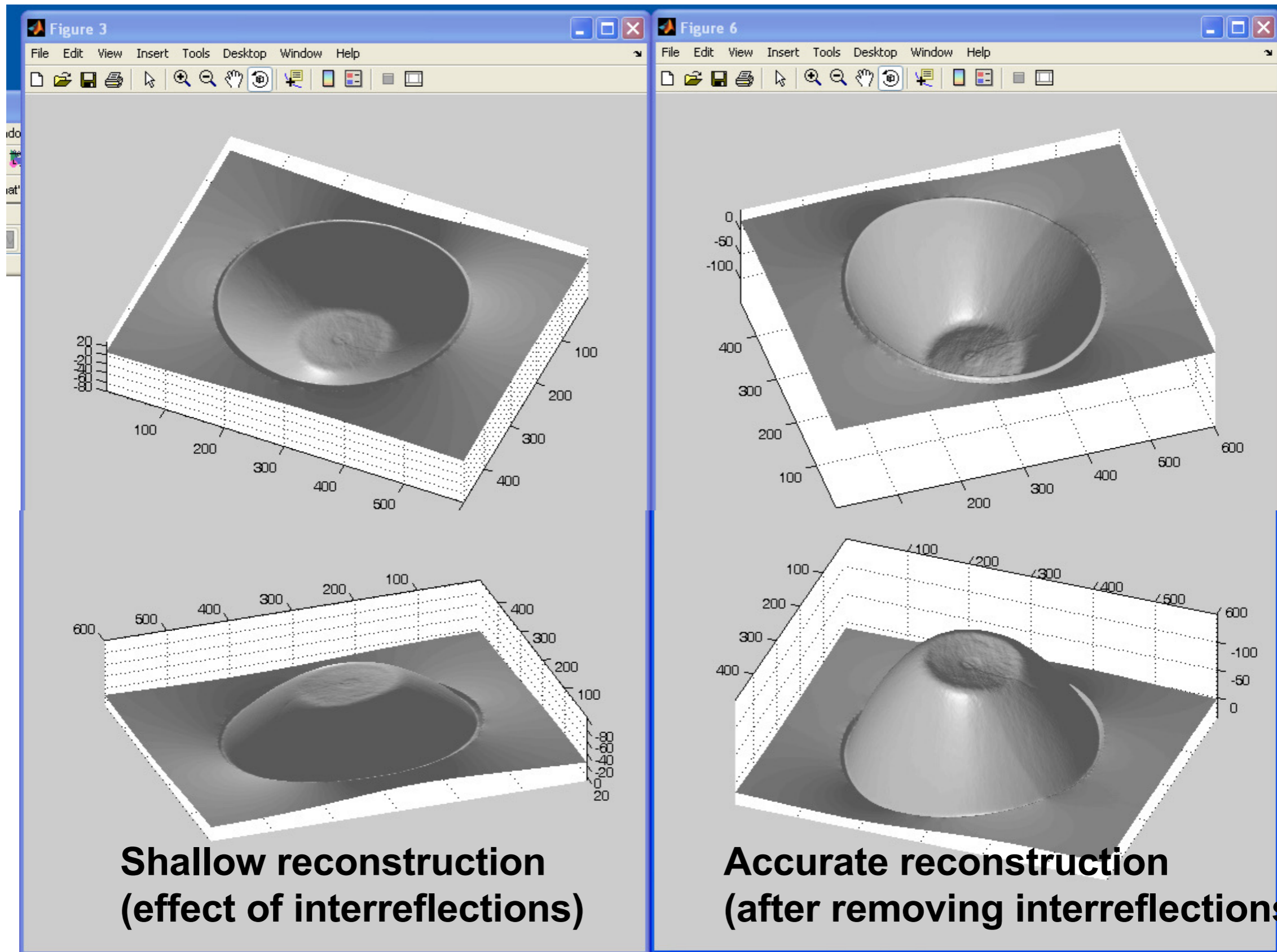

What if the light directions are unknown?

Uncalibrated photometric stereo

What if the light directions are unknown?

$$\begin{aligned} I_1 &= a\hat{n}^\top \vec{l}_1 \\ I_2 &= a\hat{n}^\top \vec{l}_2 \\ &\vdots \\ I_N &= a\hat{n}^\top \vec{l}_N \end{aligned}$$

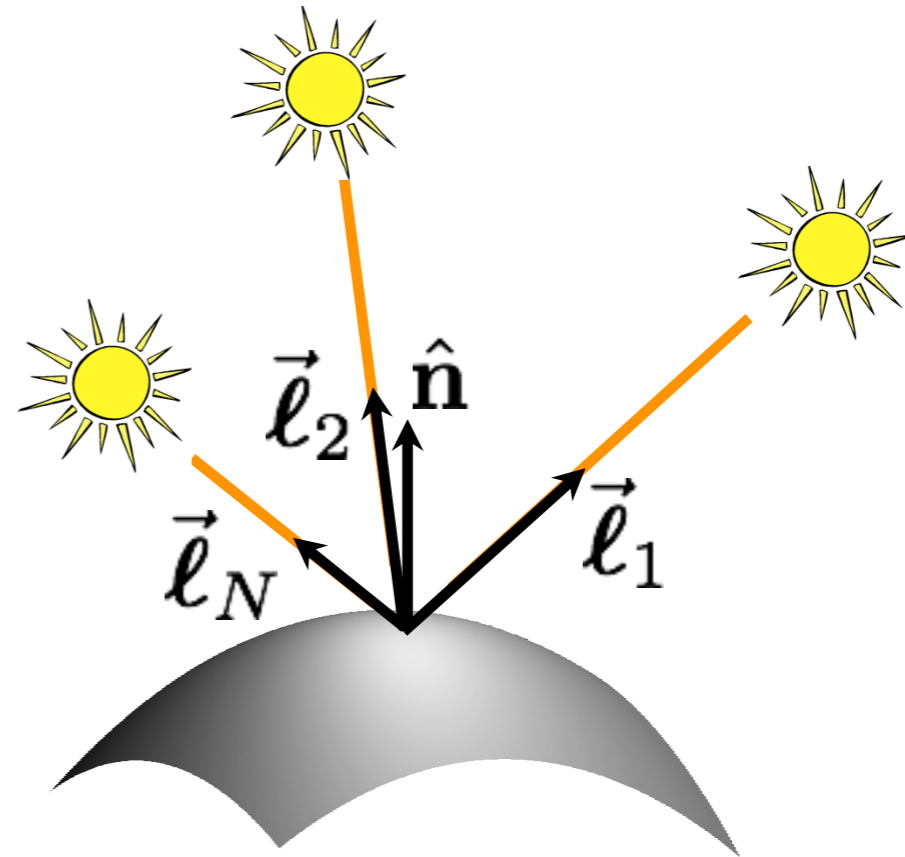
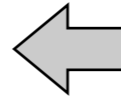

define “pseudo-normal” $\vec{b} \triangleq a\hat{n}$

solve linear system
for pseudo-normal

$$\begin{bmatrix} I_1 \\ I_2 \\ \vdots \\ I_N \end{bmatrix}_{N \times 1} = \begin{bmatrix} \vec{l}_1^\top \\ \vec{l}_2^\top \\ \vdots \\ \vec{l}_N^\top \end{bmatrix}_{N \times 3} \begin{bmatrix} \vec{b} \end{bmatrix}_{3 \times 1}$$

What if the light directions are unknown?

$$\begin{aligned} I_1 &= a\hat{n}^\top \vec{l}_1 \\ I_2 &= a\hat{n}^\top \vec{l}_2 \\ &\vdots \\ I_N &= a\hat{n}^\top \vec{l}_N \end{aligned}$$

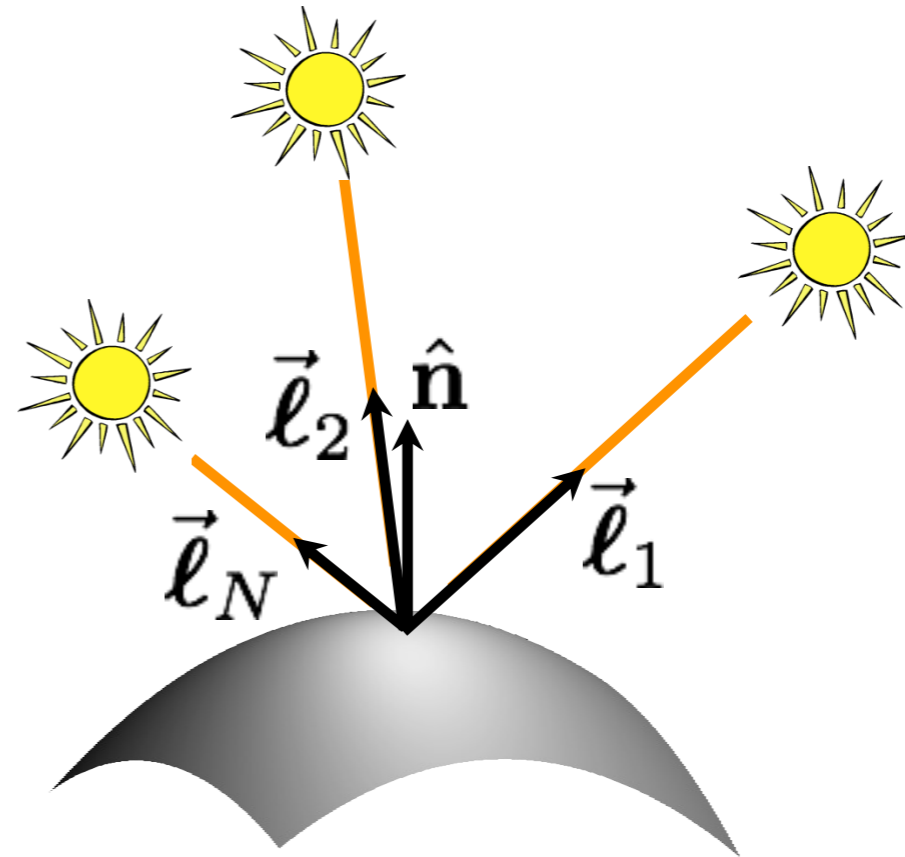
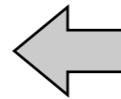

define “pseudo-normal” $\vec{b} \triangleq a\hat{n}$

solve linear system
for pseudo-normal at
each image pixel

$$\begin{bmatrix} I_1 \\ I_2 \\ \vdots \\ I_N \end{bmatrix}_{N \times M} = \begin{bmatrix} \vec{l}_1^\top \\ \vec{l}_2^\top \\ \vdots \\ \vec{l}_N^\top \end{bmatrix}_{N \times 3} \begin{bmatrix} B \end{bmatrix}_{3 \times M}$$

M: number of pixels

What if the light directions are unknown?

$$\begin{aligned} I_1 &= a \hat{n}^\top \vec{l}_1 \\ I_2 &= a \hat{n}^\top \vec{l}_2 \\ &\vdots \\ I_N &= a \hat{n}^\top \vec{l}_N \end{aligned}$$

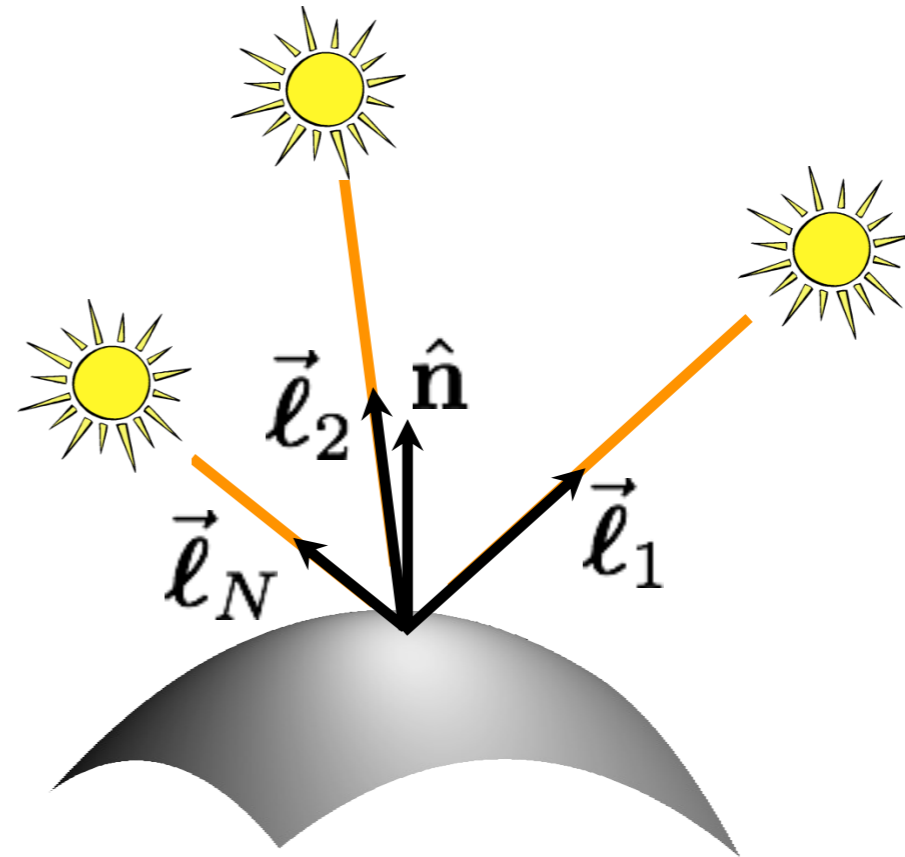
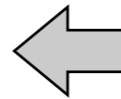

define “pseudo-normal” $\vec{b} \triangleq a \hat{n}$

solve linear system
for pseudo-normal at
each image pixel

$$\begin{bmatrix} I_1 \\ I_2 \\ \vdots \\ I_N \end{bmatrix}_{N \times M} = \begin{bmatrix} \vec{l}_1^\top \\ \vec{l}_2^\top \\ \vdots \\ \vec{l}_N^\top \end{bmatrix}_{N \times 3} \begin{bmatrix} B \end{bmatrix}_{3 \times M}$$

How do we solve this
system without
knowing light matrix L ?

Factorizing the measurement matrix

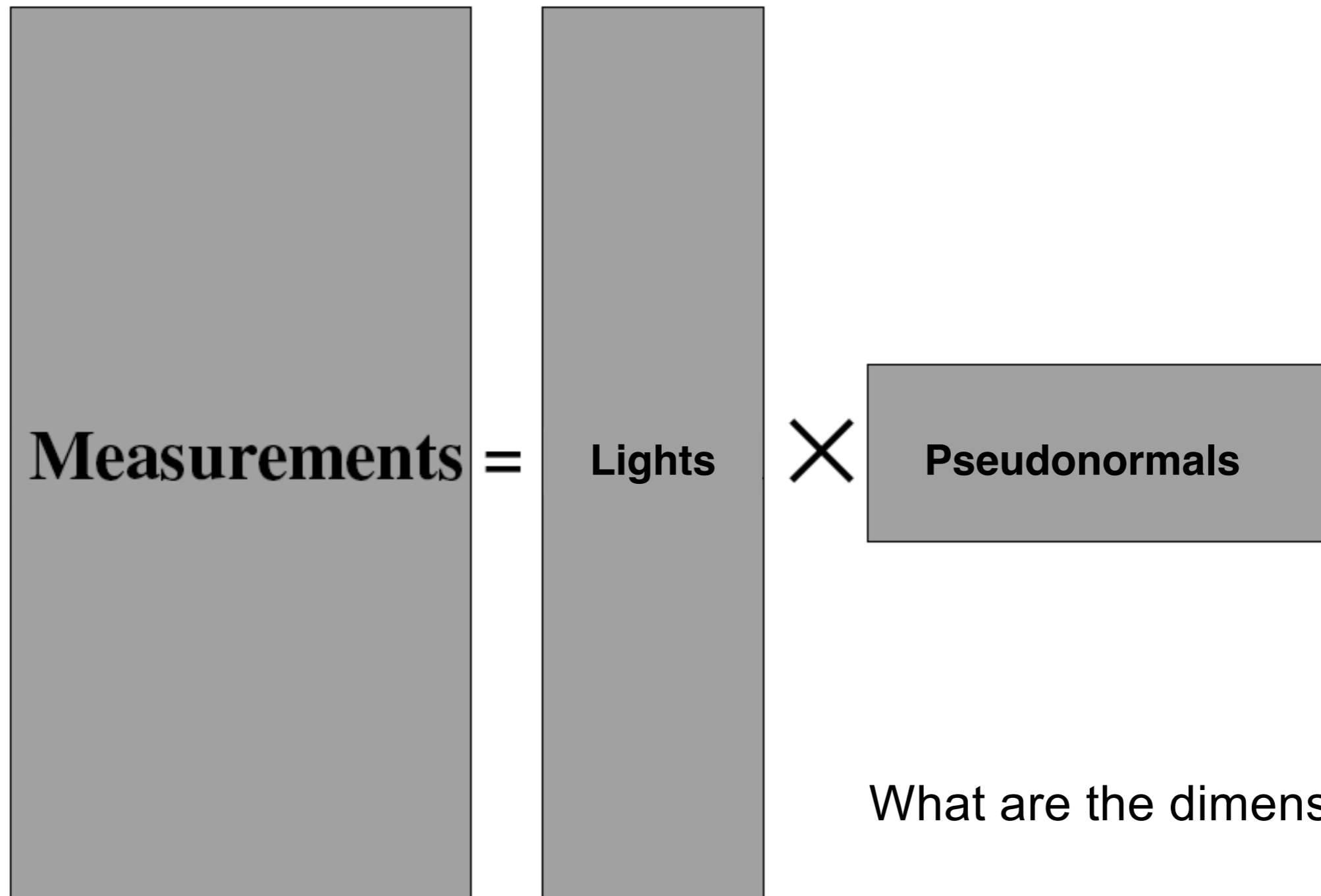

What are the dimensions?

Factorizing the measurement matrix

- Singular value decomposition:

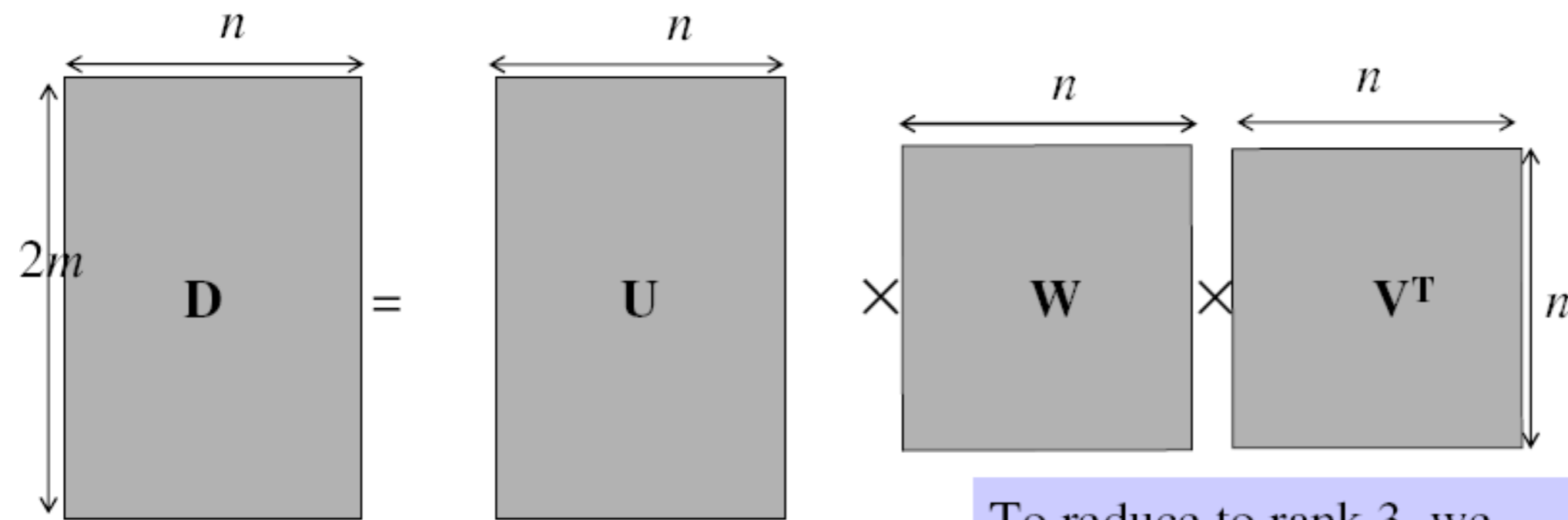

To reduce to rank 3, we just need to set all the singular values to 0 except for the first 3

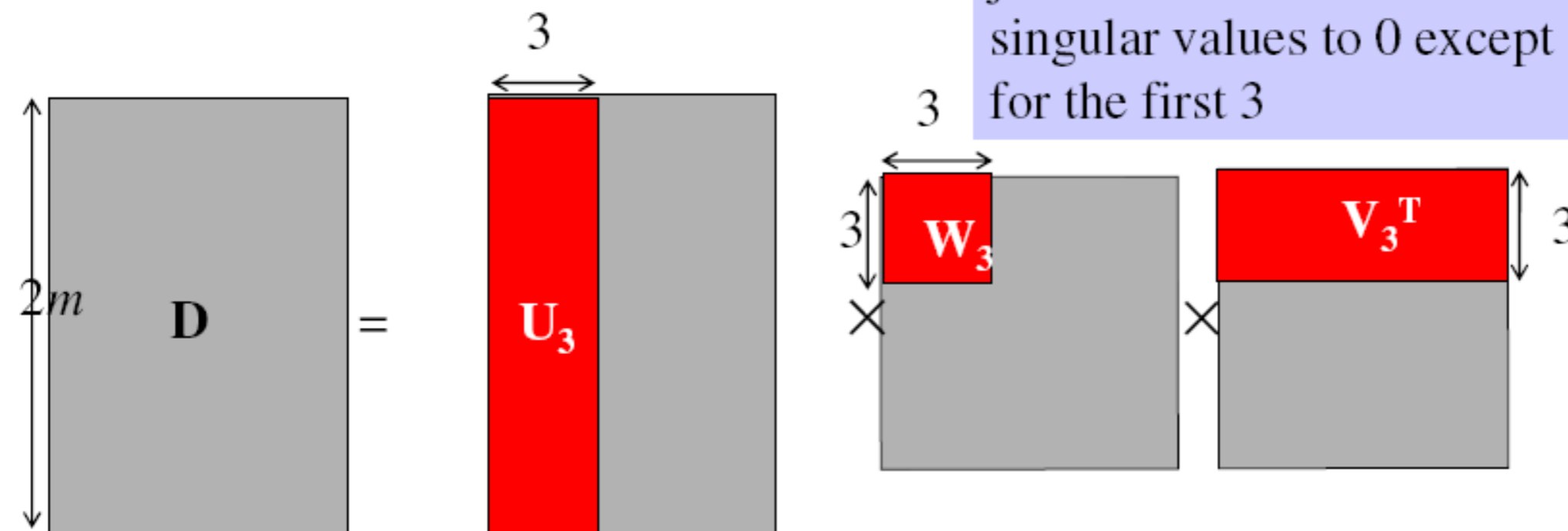

This decomposition minimizes $|\mathbf{I}-\mathbf{LB}|^2$

Are the results unique?

Are the results unique?

We can insert any 3x3 matrix Q in the decomposition and get the same images:

$$\mathbf{I} = \mathbf{L} \mathbf{B} = (\mathbf{L} \mathbf{Q}^{-1}) (\mathbf{Q} \mathbf{B})$$

Are the results unique?

We can insert any 3x3 matrix Q in the decomposition and get the same images:

$$\mathbf{I} = \mathbf{L} \mathbf{B} = (\mathbf{L} \mathbf{Q}^{-1}) (\mathbf{Q} \mathbf{B})$$

Can we use any assumptions to remove some of these 9 degrees of freedom?

Generalized bas-relief
ambiguity

Enforcing integrability

What does the matrix \mathbf{B} correspond to?

Enforcing integrability

What does the matrix **B** correspond to?

- Surface representation as a depth image (also known as Monge surface):

$$z = f(x, y)$$

↑
depth at each pixel

pixel coordinates in image space

- Unnormalized normal:

$$\tilde{n}(x, y) = \left(\frac{df}{dx}, \frac{df}{dy}, -1 \right)$$

- Actual normal:

$$n(x, y) = \tilde{n}(x, y) / \|\tilde{n}(x, y)\|$$

- Pseudo-normal:

$$b(x, y) = a(x, y)n(x, y)$$

- Rearrange into 3xN matrix **B**.

Enforcing integrability

What does the integrability constraint correspond to?

Enforcing integrability

What does the integrability constraint correspond to?

- Differentiation order should not matter:

$$\frac{d}{dy} \frac{df(x, y)}{dx} = \frac{d}{dx} \frac{df(x, y)}{dy}$$

- Can you think of a way to express the above using pseudo-normals \mathbf{b} ?

Enforcing integrability

What does the integrability constraint correspond to?

- Differentiation order should not matter:

$$\frac{d}{dy} \frac{df(x, y)}{dx} = \frac{d}{dx} \frac{df(x, y)}{dy}$$

- Can you think of a way to express the above using pseudo-normals \mathbf{b} ?

$$\frac{d}{dy} \frac{b_1(x, y)}{b_3(x, y)} = \frac{d}{dx} \frac{b_2(x, y)}{b_3(x, y)}$$

Enforcing integrability

What does the integrability constraint correspond to?

- Differentiation order should not matter:

$$\frac{d}{dy} \frac{df(x, y)}{dx} = \frac{d}{dx} \frac{df(x, y)}{dy}$$

- Can you think of a way to express the above using pseudo-normals \mathbf{b} ?

$$\frac{d}{dy} \frac{b_1(x, y)}{b_3(x, y)} = \frac{d}{dx} \frac{b_2(x, y)}{b_3(x, y)}$$

- Simplify to:

$$b_3(x, y) \frac{db_1(x, y)}{dy} - b_1(x, y) \frac{db_3(x, y)}{dy} = b_2(x, y) \frac{db_1(x, y)}{dx} - b_1(x, y) \frac{db_2(x, y)}{dx}$$

Enforcing integrability

What does the integrability constraint correspond to?

- Differentiation order should not matter:

$$\frac{d}{dy} \frac{df(x, y)}{dx} = \frac{d}{dx} \frac{df(x, y)}{dy}$$

- Can you think of a way to express the above using pseudo-normals \mathbf{b} ?

$$\frac{d}{dy} \frac{b_1(x, y)}{b_3(x, y)} = \frac{d}{dx} \frac{b_2(x, y)}{b_3(x, y)}$$

- Simplify to:

$$b_3(x, y) \frac{db_1(x, y)}{dy} - b_1(x, y) \frac{db_3(x, y)}{dy} = b_2(x, y) \frac{db_1(x, y)}{dx} - b_1(x, y) \frac{db_2(x, y)}{dx}$$

- If \mathbf{B}_e is the pseudo-normal matrix we get from SVD, then find the 3x3 transform \mathbf{D} such that $\mathbf{B} = \mathbf{D} \cdot \mathbf{B}_e$ is the closest to satisfying integrability in the least-squares sense.

Enforcing integrability

Does enforcing integrability remove all ambiguities?

Generalized Bas-relief ambiguity

If \mathbf{B} is integrable, then:

- $\mathbf{B}' = \mathbf{G}^{-T} \cdot \mathbf{B}$ is also integrable for all \mathbf{G} of the form ($\lambda \neq 0$)

$$\mathbf{G} = \begin{bmatrix} 1 & 0 & 0 \\ 0 & 1 & 0 \\ \mu & \nu & \lambda \end{bmatrix}$$

- Combined with transformed lights $\mathbf{S}' = \mathbf{G} \cdot \mathbf{S}$, the transformed pseudonormals produce the same images as the original pseudonormals.
- This ambiguity cannot be removed using shadows.
- This ambiguity *can* be removed using interreflections or additional assumptions.

This ambiguity is known as the generalized bas-relief ambiguity.

Generalized Bas-relief ambiguity

When $\mu = \nu = 0$, \mathbf{G} is equivalent to the transformation employed by relief sculptures.



When $\mu = \nu = 0$ and $\lambda = \pm 1$, top/down ambiguity.

Otherwise, includes shearing.

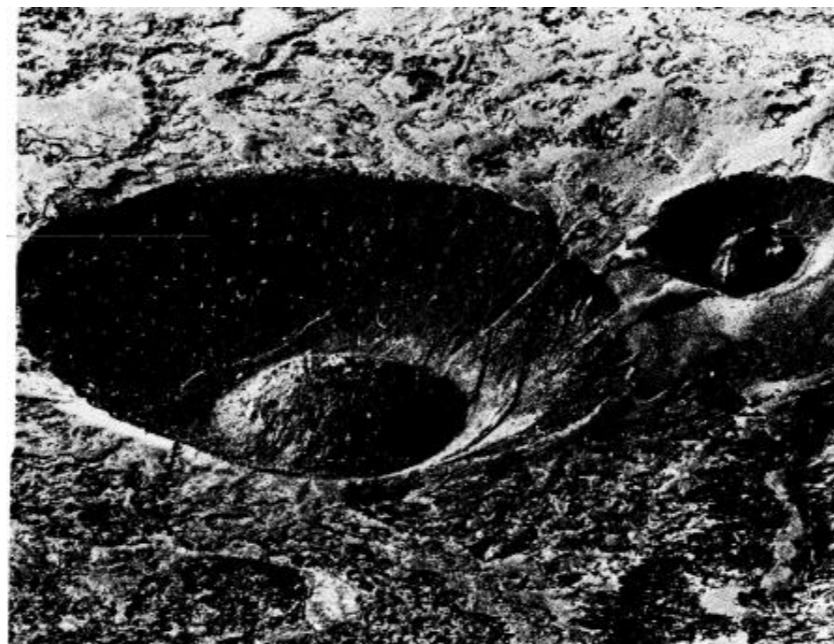
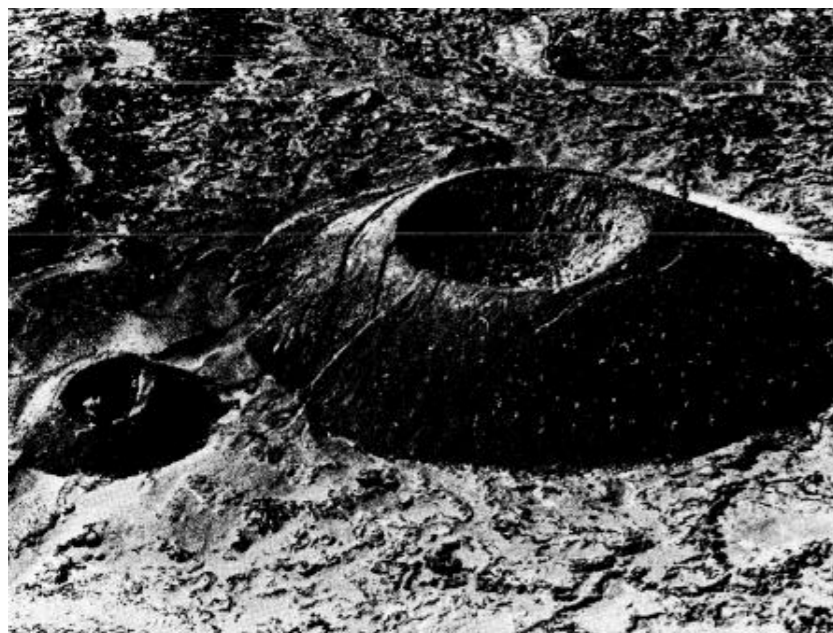

What assumptions have we made for all this?

What assumptions have we made for all this?

- Lambertian BRDF
- Directional lighting
- Orthographic camera
- No interreflections or scattering

Shape independent of BRDF via reciprocity: “Helmholtz Stereopsis”

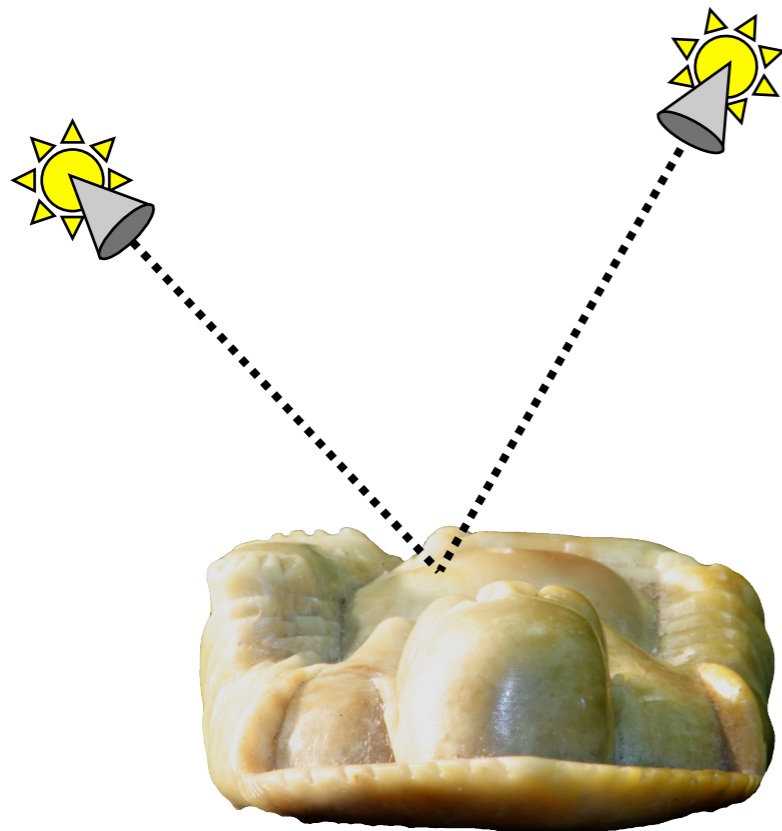

$$I = f(\text{shape}, \text{illumination}, \text{reflectance})$$

$$f^{-1} =$$



Shape from shading

Can we reconstruct shape
from one image?

Single-lighting is ambiguous

ASSUMPTION 1:
LAMBERTIAN

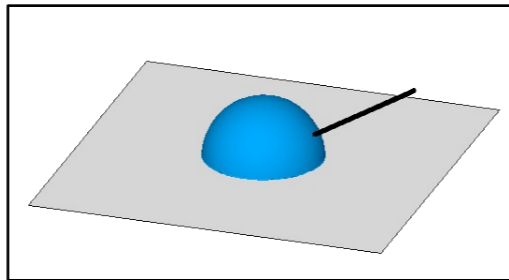

ASSUMPTION 2:
DIRECTIONAL LIGHTING

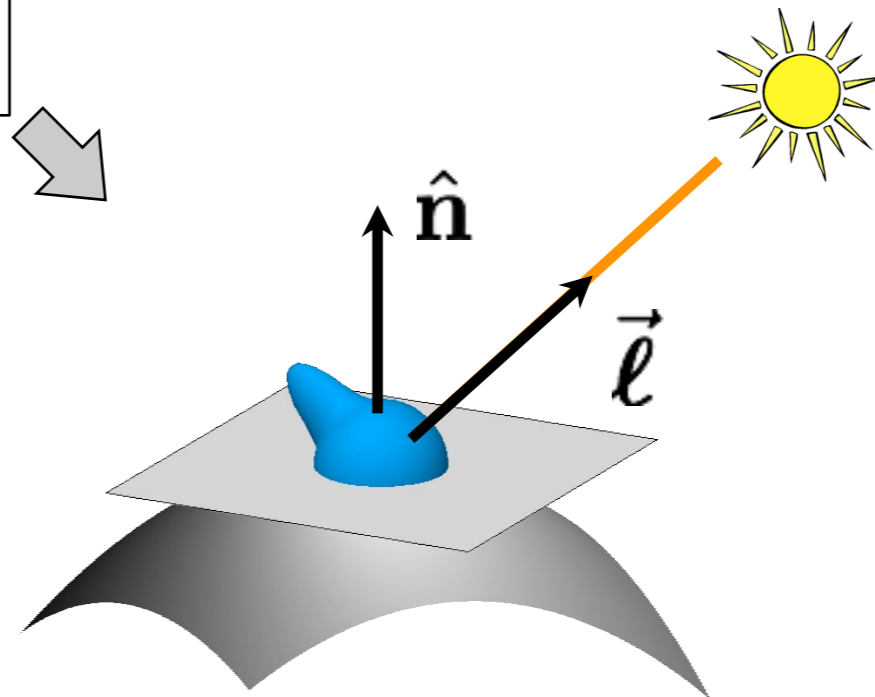

$$L^{\text{out}}(\hat{\omega}) = \int_{\Omega_{\text{in}}} f(\hat{\omega}_{\text{in}}, \hat{\omega}_{\text{out}}) L^{\text{in}}(\hat{\omega}_{\text{in}}) \cos \theta_{\text{in}} d\hat{\omega}_{\text{in}}$$

$$I = a \hat{n}^{\top} \vec{l}$$

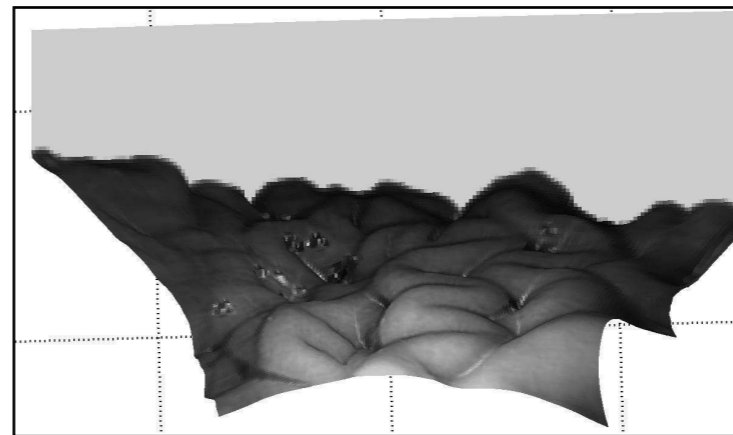

[Prados, 2004]

Stereographic Projection

(p, q) -space (gradient space)

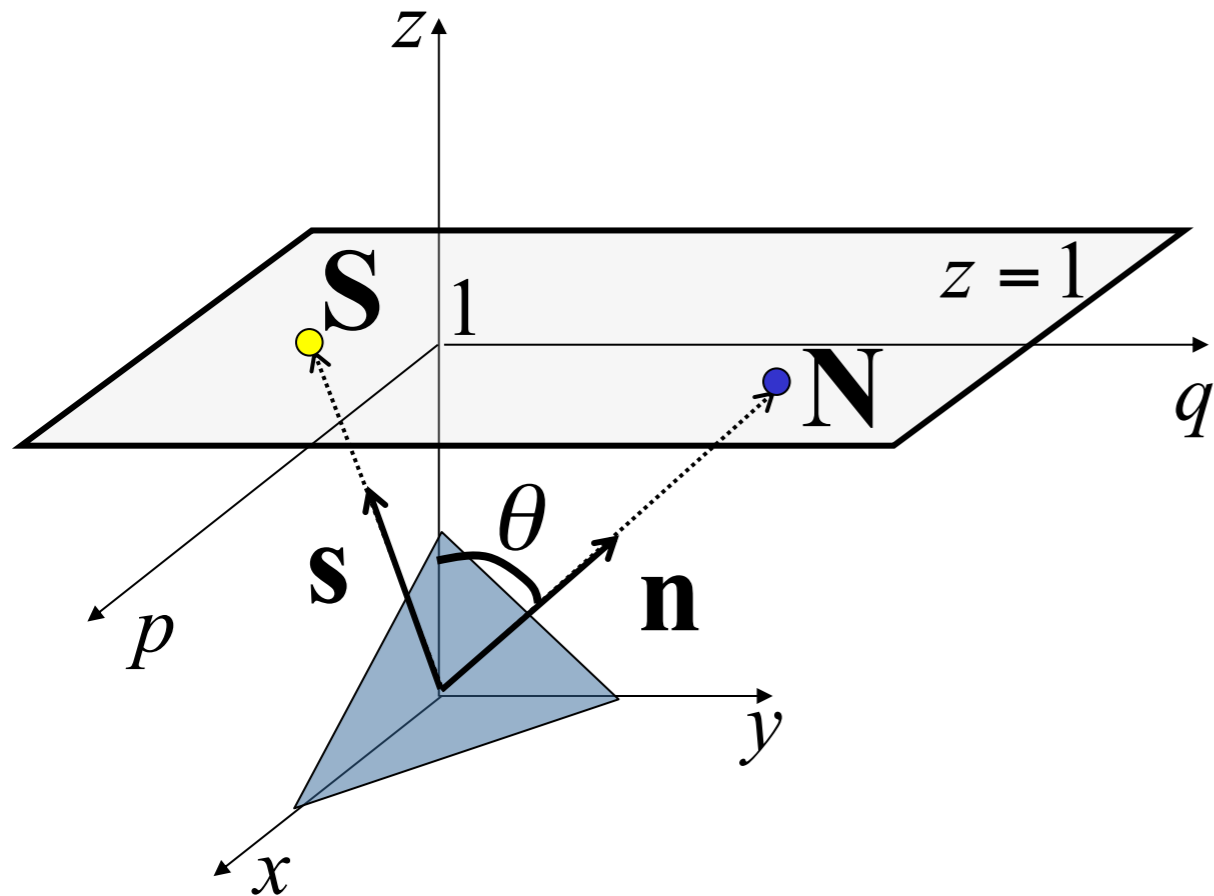

Problem

(p, q) can be infinite when $\theta = 90^\circ$

(f, g) -space

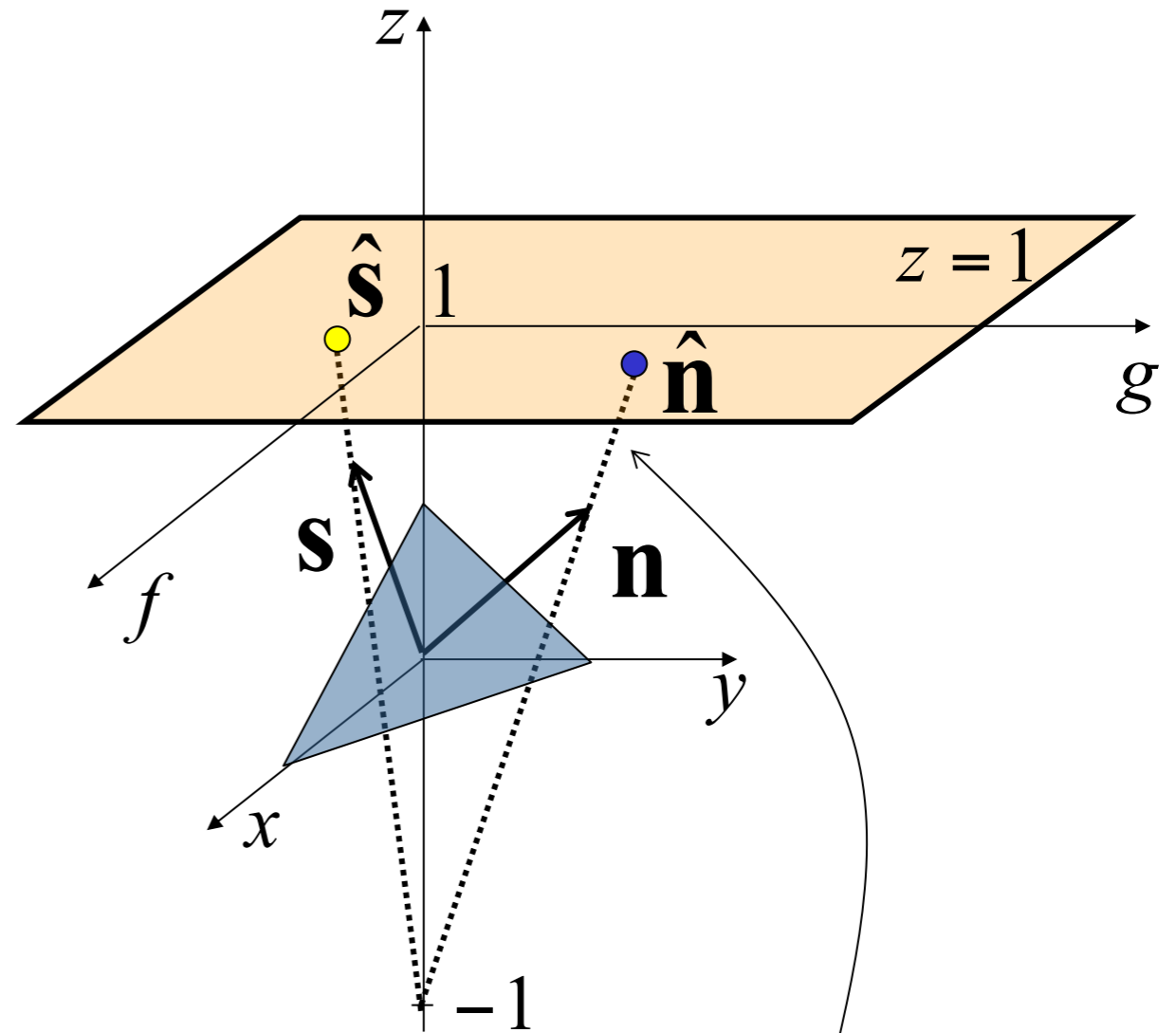

$$f = \frac{2p}{1 + \sqrt{1 + p^2 + q^2}} \quad g = \frac{2q}{1 + \sqrt{1 + p^2 + q^2}}$$

Redefine reflectance map as $R(f, g)$

Image Irradiance Constraint

- Image irradiance should match the reflectance map

Minimize

$$e_i = \iint_{\text{image}} (I(x, y) - R(f, g))^2 dx dy$$

(minimize errors in image irradiance in the image)

Smoothness Constraint

- Used to constrain shape-from-shading
- Relates orientations (f, g) of neighboring surface points

Minimize

$$e_s = \iint_{\text{image}} (f_x^2 + f_y^2) + (g_x^2 + g_y^2) dx dy$$

(f, g) : surface orientation under stereographic projection

$$f_x = \frac{\partial f}{\partial x}, f_y = \frac{\partial f}{\partial y}, g_x = \frac{\partial g}{\partial x}, g_y = \frac{\partial g}{\partial y}$$

(penalize rapid changes in surface orientation f and g over the image)

Shape-from-Shading

- Find surface orientations (f, g) at all image points that minimize

$$e = e_s + \lambda e_i$$

weight
↓
smoothness constraint
↑
image irradiance error

Minimize

$$e = \iint_{\text{image}} (f_x^2 + f_y^2) + (g_x^2 + g_y^2) + \lambda (I(x, y) - R(f, g))^2 dx dy$$

Numerical Shape-from-Shading

- **Smoothness error** at image point (i,j)

$$s_{i,j} = \frac{1}{4} \left((f_{i+1,j} - f_{i,j})^2 + (f_{i,j+1} - f_{i,j})^2 + (g_{i+1,j} - g_{i,j})^2 + (g_{i,j+1} - g_{i,j})^2 \right)$$

Of course you can consider more neighbors (smoother results)

- **Image irradiance error** at image point (i,j)

$$r_{i,j} = \left(I_{i,j} - R(f_{i,j}, g_{i,j}) \right)^2$$

Find $\{f_{i,j}\}$ and $\{g_{i,j}\}$ that minimize

$$e = \sum_i \sum_j (s_{i,j} + \lambda r_{i,j})$$

Results

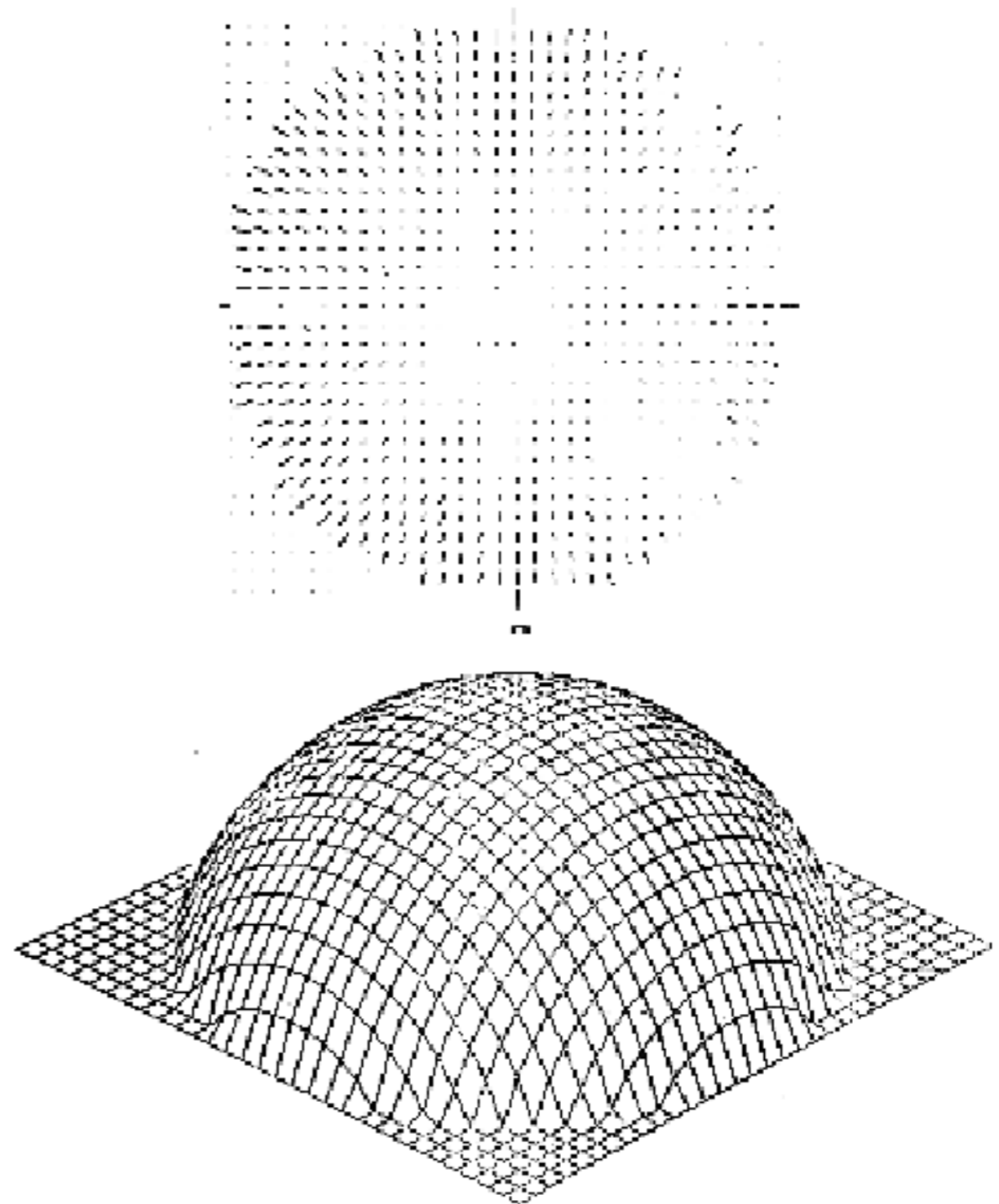
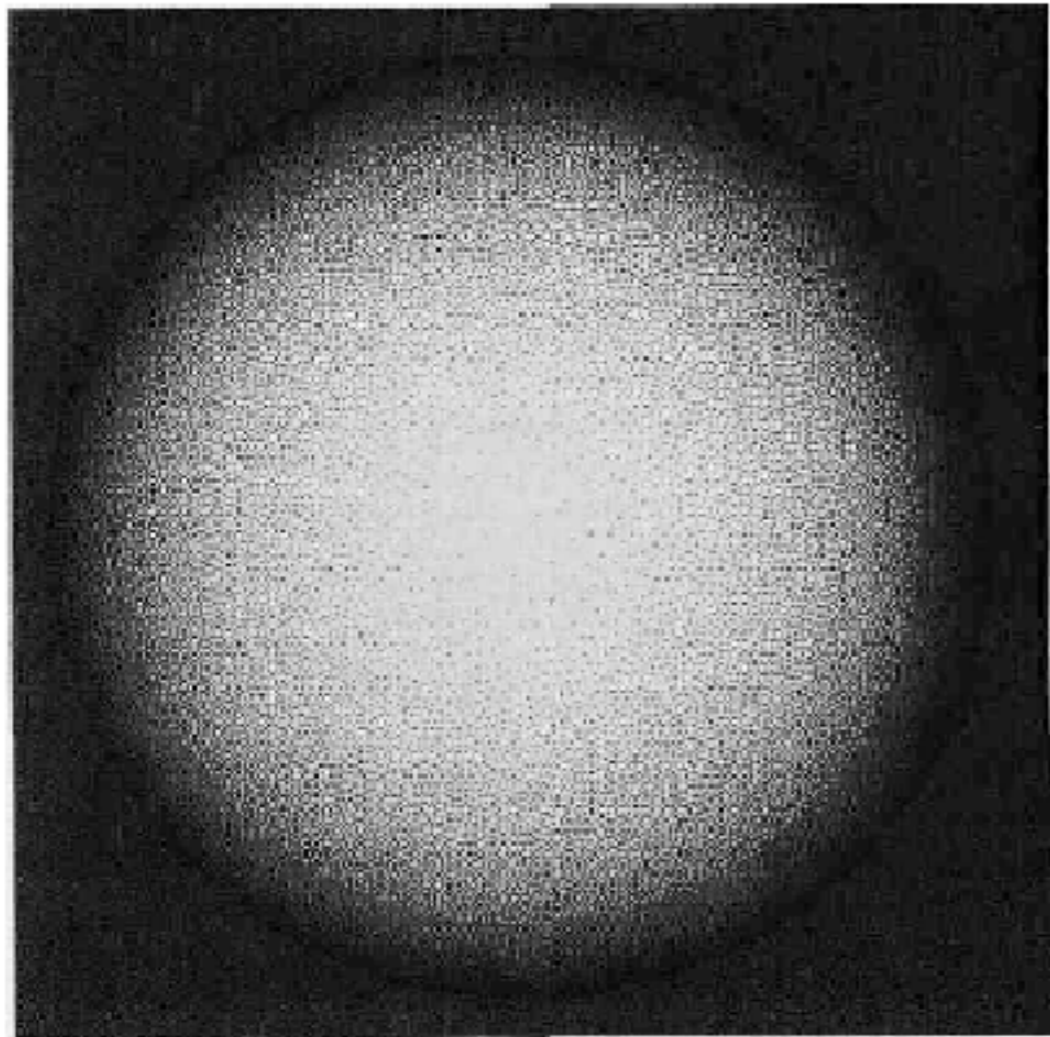

by Ikeuchi and Horn

Results

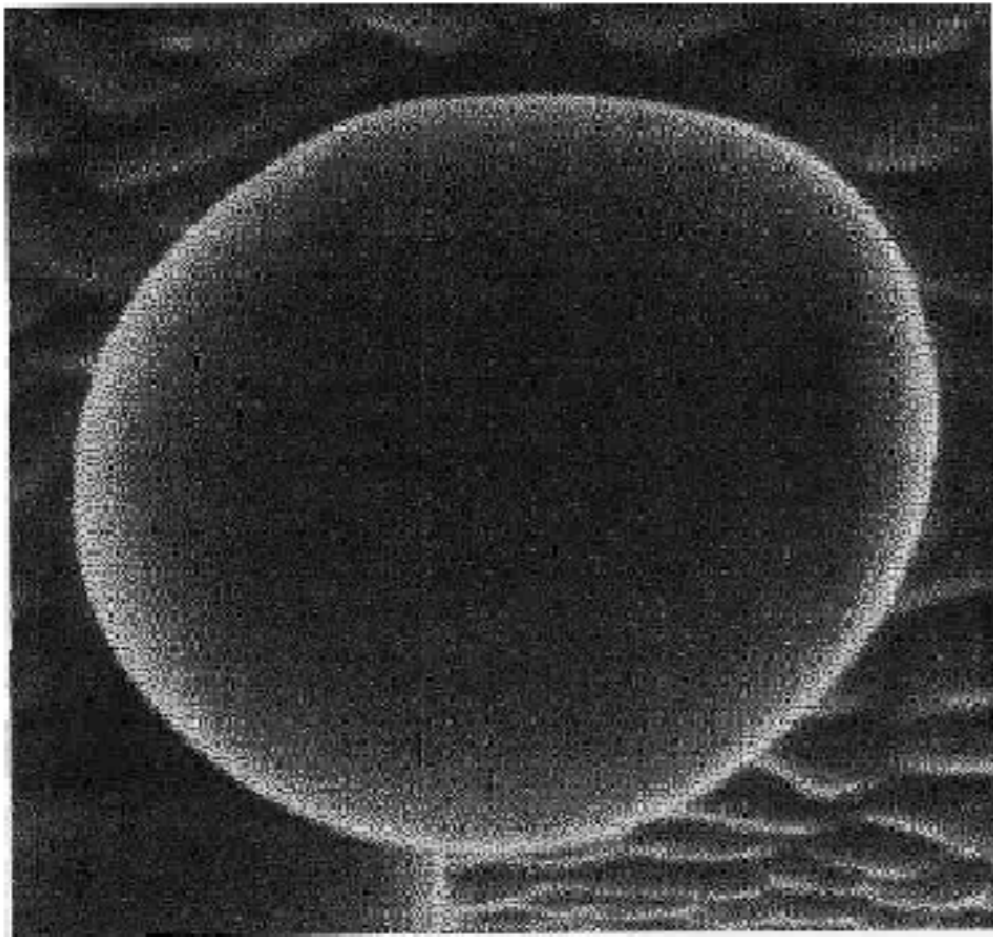

Scanning Electron Microscope image
(inverse intensity)

by Ikeuchi and Horn

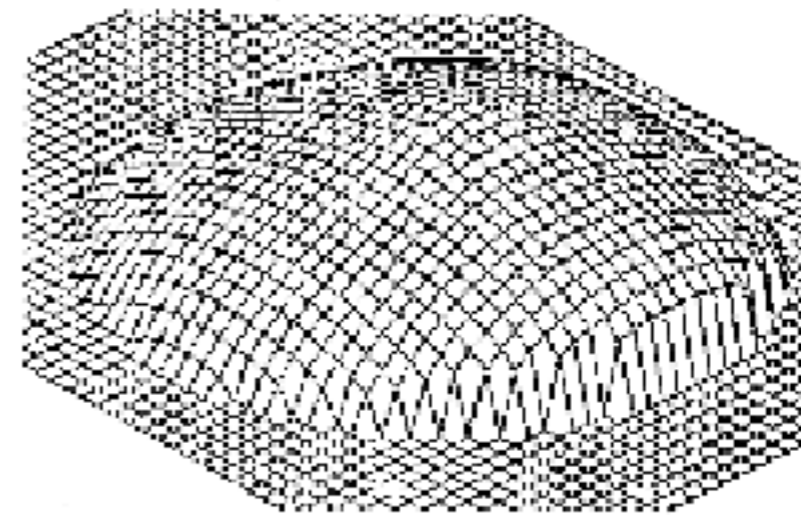
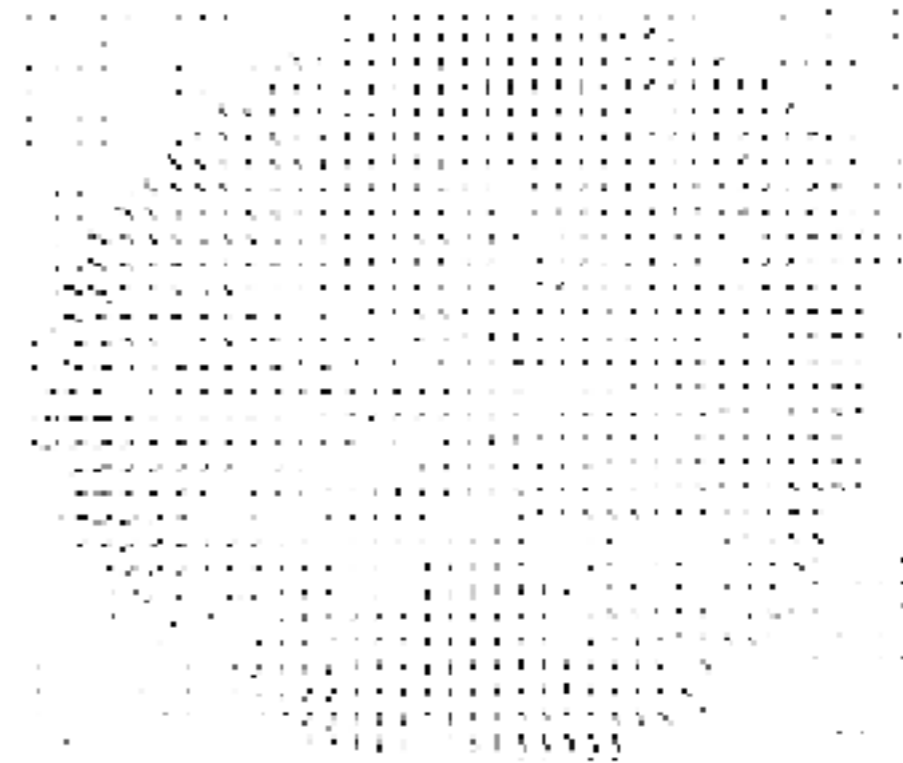

More modern results



Resolution: 640 x 500; Re-rendering Error: 0.0075.

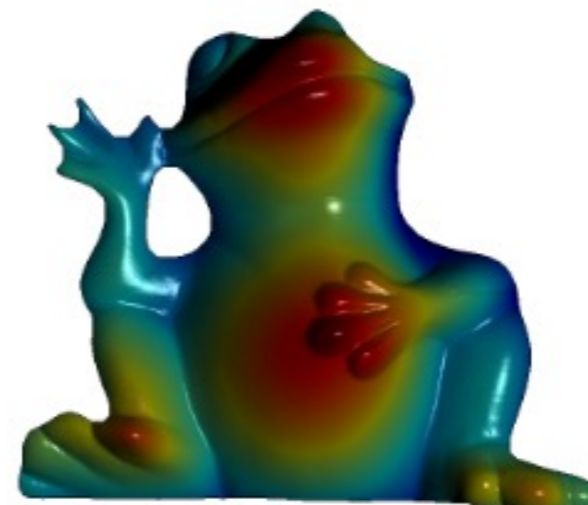
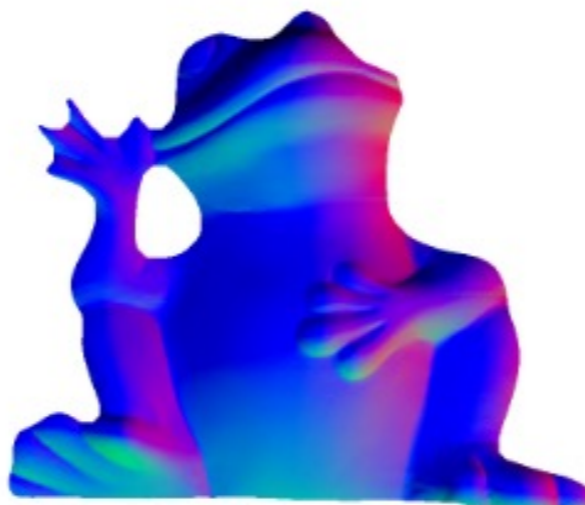

Resolution: 590 x 690; Re-rendering Error: 0.0083.

References

Basic reading:

- Szeliski, Section 2.2.
- Gortler, Chapter 21.

This book by Steven Gortler has a great *introduction* to radiometry, reflectance, and their use for image formation.

Additional reading:

- Oren and Nayar, “Generalization of the Lambertian model and implications for machine vision,” IJCV 1995.
The paper introducing the most common model for rough diffuse reflectance.
- Debevec, “Rendering Synthetic Objects into Real Scenes,” SIGGRAPH 1998.
The paper that introduced the notion of the environment map, the use of chrome spheres for measuring such maps, and the idea that they can be used for easy rendering.
- Lalonde et al., “Estimating the Natural Illumination Conditions from a Single Outdoor Image,” IJCV 2012.
A paper on estimating outdoors environment maps from just one image.
- Basri and Jacobs, “Lambertian reflectance and linear subspaces,” ICCV 2001.
- Ramamoorthi and Hanrahan, “A signal-processing framework for inverse rendering,” SIGGRAPH 2001.
- Sloan et al., “Precomputed radiance transfer for real-time rendering in dynamic, low-frequency lighting environments,” SIGGRAPH 2002.
Three papers describing the use of spherical harmonics to model low-frequency illumination, as well as the low-pass filtering effect of Lambertian reflectance on illumination.
- Zhang et al., “Shape-from-shading: a survey,” PAMI 1999.
A review of perceptual and computational aspects of shape from shading.
- Woodham, “Photometric method for determining surface orientation from multiple images,” Optical Engineering 1980.
The paper that introduced photometric stereo.
- Yuille and Snow, “Shape and albedo from multiple images using integrability,” CVPR 1997.
- Belhumeur et al., “The bas-relief ambiguity,” IJCV 1999.
- Papadimitri and Favaro, “A new perspective on uncalibrated photometric stereo,” CVPR 2013.
Three papers discussing uncalibrated photometric stereo. The first paper shows that, when the lighting directions are not known, by assuming integrability, one can reduce unknowns to the bas-relief ambiguity. The second paper discusses the bas-relief ambiguity in a more general context. The third paper shows that, if instead of an orthographic camera one uses a perspective camera, this is further reduced to just a scale ambiguity.
- Alldrin et al., “Resolving the generalized bas-relief ambiguity by entropy minimization,” CVPR 2007.
A popular technique for resolving the bas-relief ambiguity in uncalibrated photometric stereo.
- Zickler et al., “Helmholtz stereopsis: Exploiting reciprocity for surface reconstruction,” IJCV 2002.
A method for photometric stereo reconstruction under arbitrary BRDF.
- Nayar et al., “Shape from interreflections,” IJCV 1991.
- Chandraker et al., “Reflections on the generalized bas-relief ambiguity,” CVPR 2005.
Two papers discussing how one can perform photometric stereo (calibrated or otherwise) in the presence of strong interreflections.
- Frankot and Chellappa, “A method for enforcing integrability in shape from shading algorithms,” PAMI 1988.
- Agrawal et al., “What is the range of surface reconstructions from a gradient field?,” ECCV 2006.
Two papers discussing how one can integrate a normal field to reconstruct a surface.